

INTRODUCTION

The S80/S580 return grilles are designed to fit most common commercial and residential applications. They offer fixed 3/4" blade spacing with 35° deflection and a 1 1/4" flange.

The S85/S585 return grilles are designed to fit most applications where limited sight through the grille is required. They offer fixed 1/2" blade spacing with 35° deflection and a 1 1/4" flange.

If the application requires large amounts of air to be returned through the return grille, then the blade deflection of 0° should be used to keep the pressure drop and sound to a minimum.

MODELS

- S80 - Fixed deflection steel return grille, 3/4" blade spacing
- S580 - Fixed deflection aluminum return grille, 3/4" blade spacing
- S85 - Fixed deflection steel return grille, 1/2" blade spacing
- S585 - Fixed deflection aluminum return grille, 1/2" blade spacing

FEATURES

- Horizontal (H) or vertical (V) front blades
- 35° (H/V) or 0° (HZ/VZ) blade deflection
- Standard finish is #44 British White
- Optional finishes available

ACCESSORIES

- Steel opposed blade damper (model OBD)
- Steel painted opposed blade damper (model POBD)
- Aluminum opposed blade damper (model 5OBD)
- Square to round adapter (model SRAC325)
- Steel plaster frame (model 8PF)
- Aluminum plaster frame (model 58PF)
- 1" or 2" filter frame, minimum size is 8"x8" and maximum is 48" x 36" (model 5FF)



S80



S85

S80 / S580 / S85 / S585 SERIES



Return Grille | Single, Fixed Deflection

DIMENSIONAL DATA

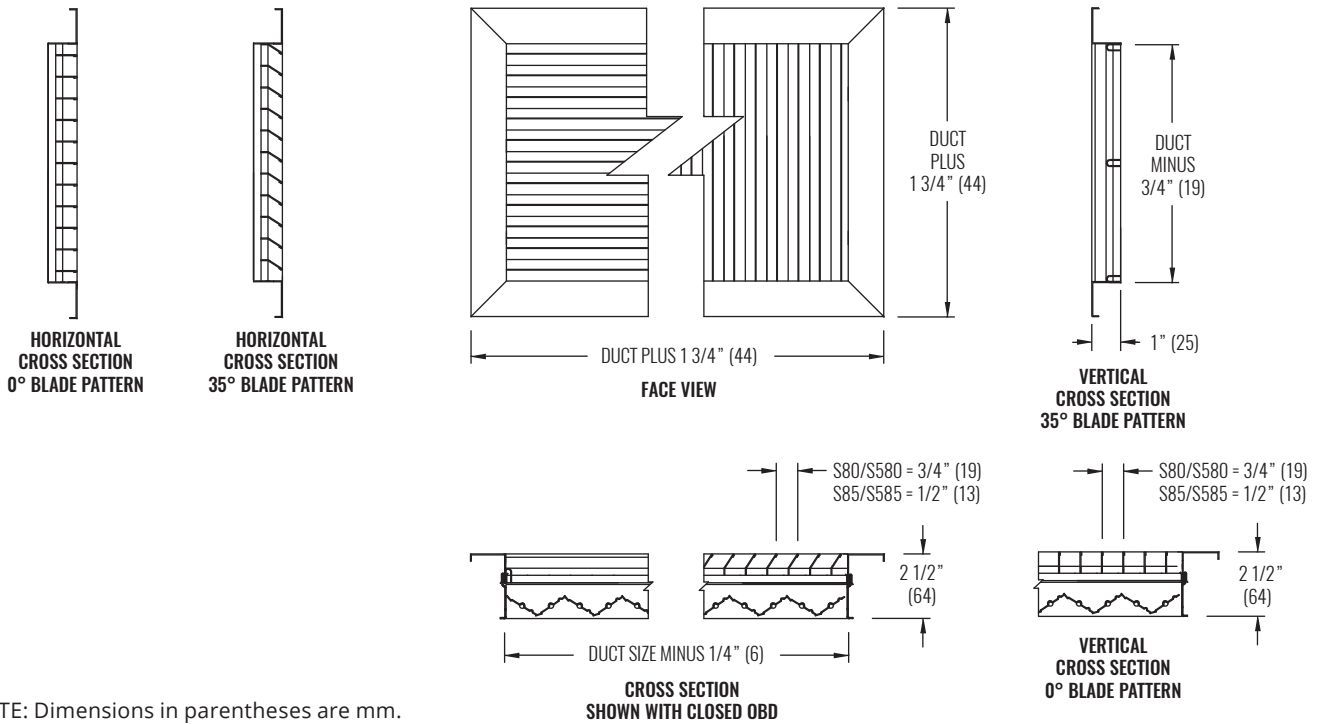

NOTE: Dimensions in parentheses are mm.

DIMENSIONAL DATA | FRAMES & MOUNTINGS

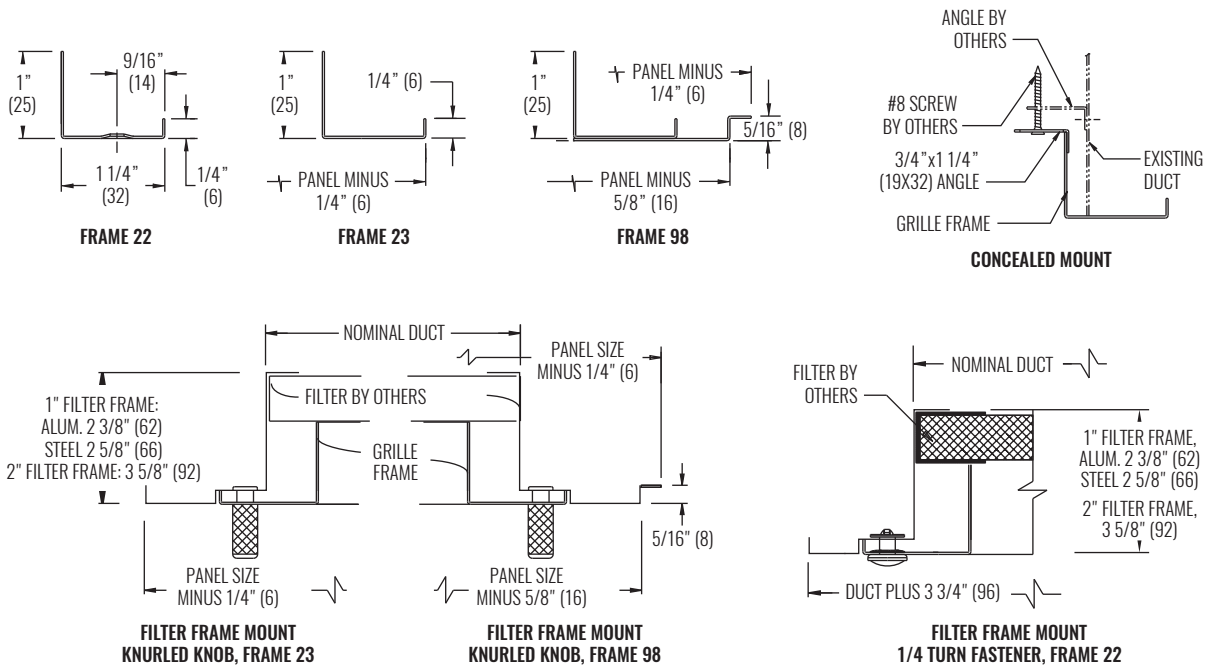

NOTE: Dimensions in parentheses are mm. Maximum duct size for F23 and F98 = Panel Size - 5" (127).

SOUND CHARTS | S80, S580 | 35° DEFLECTION (NO DAMPER)

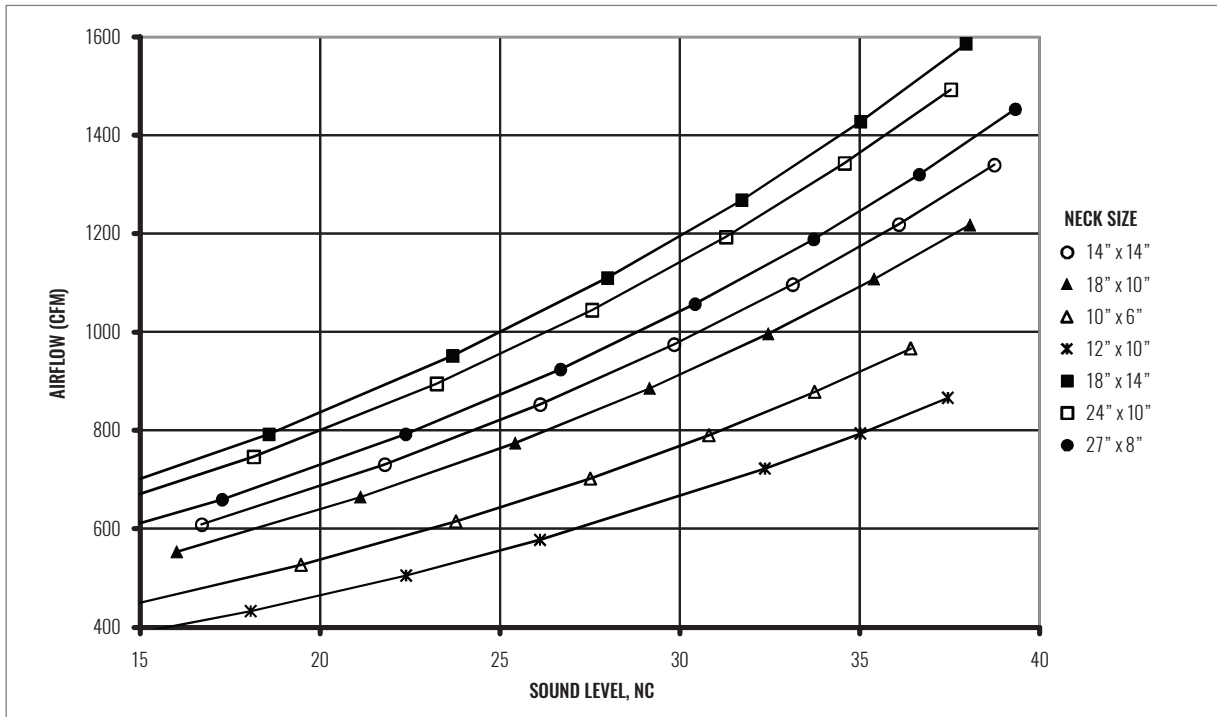
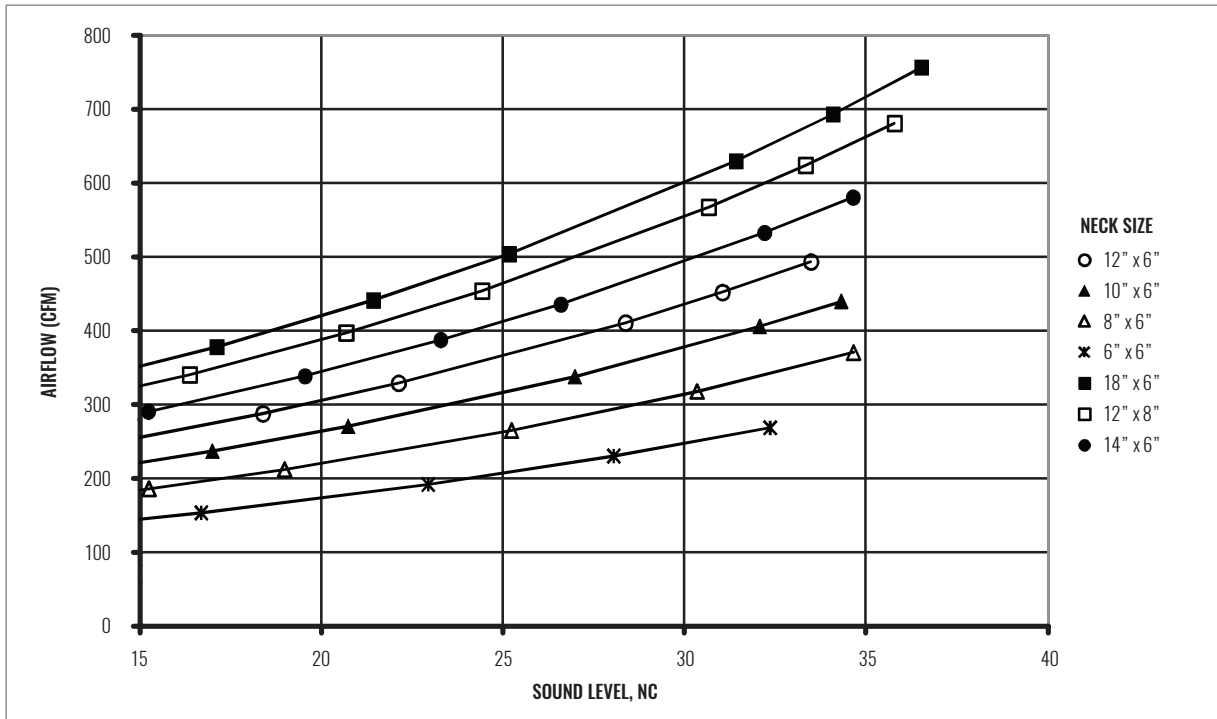

GRILLES | RETURN

S80 / S580 / S85 / S585 SERIES



Return Grille | Single, Fixed Deflection

SOUND CHARTS | S80, S580 | 35° DEFLECTION (NO DAMPER)

GRILLES | RETURN

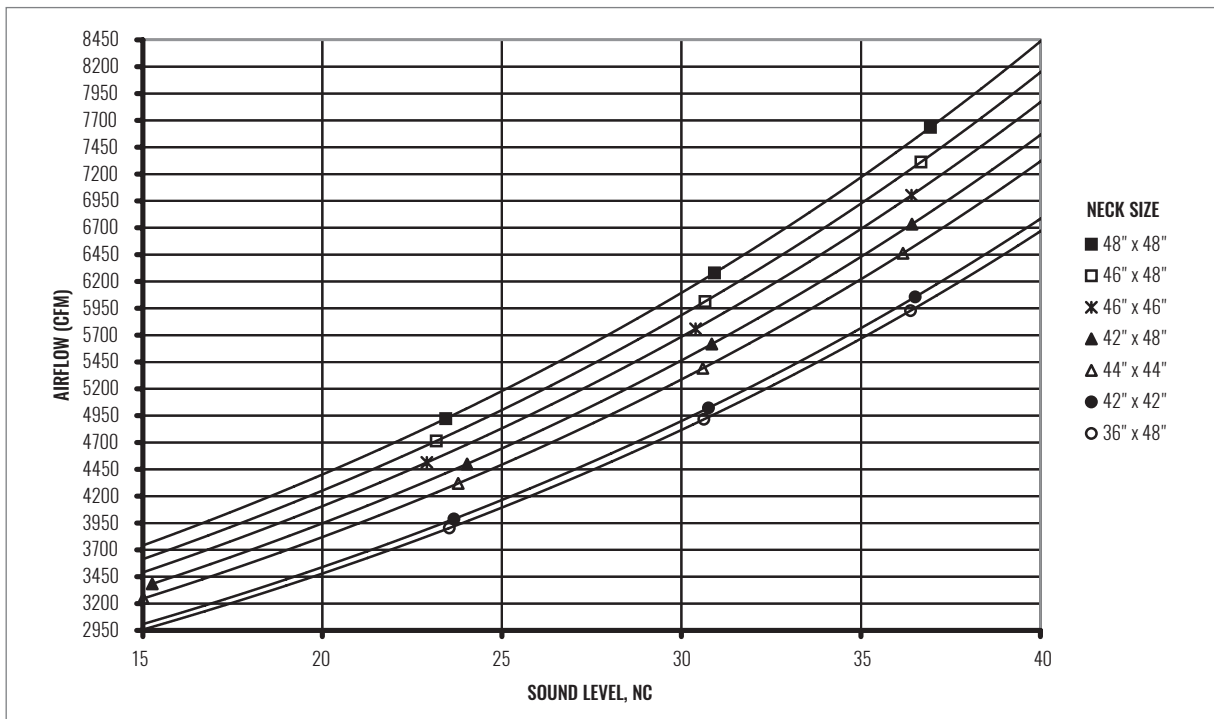
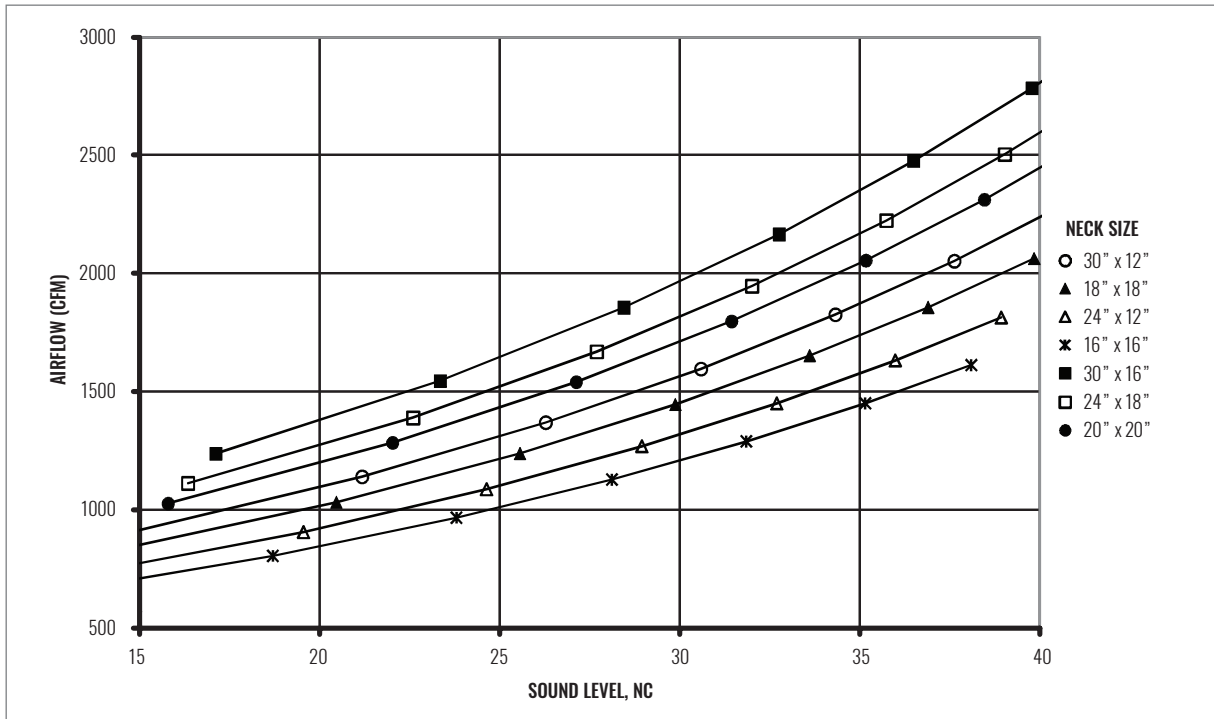

PERFORMANCE DATA | S80, S580 | 35° DEFLECTION (NO DAMPER)

IP DATA					NC	METRIC DATA					OCTAVE BAND, dB						
NOM DUCT	DUCT AREA	NECK VEL	AIRFLOW	Ps		NOM DUCT	DUCT AREA	NECK VEL	AIRFLOW	Ps	OCTAVE BAND, dB						
in	ft ²	FPM	CFM	"WG		mm	m ²	m/s	L/s	Pa	2	3	4	5	6	7	
6" x 6"	0.25	300	57	-0.07	-	152 x 152	0.02	1.52	27	-1.7	23	15	-	-	-	-	
		400	77	-0.12	-			2.03	36	-3.0	26	20	16	-	-	-	
		500	96	-0.19	-			2.54	45	-4.7	28	24	21	-	-	-	
		600	115	-0.27	-			3.05	54	-6.7	29	27	26	16	-	-	
		700	134	-0.37	13			3.56	63	-9.2	31	30	29	20	-	-	
		800	153	-0.48	17			4.06	72	-12.0	32	32	33	24	13	-	
		1000	191	-0.75	23			5.08	90	-18.7	34	36	38	31	21	16	
		1200	230	-1.08	28			6.10	108	-27.0	36	39	42	37	27	22	
		1400	268	-1.47	32			7.11	126	-36.7	37	42	46	41	32	27	
8" x 6"	0.33	300	79	-0.07	-	203 x 152	0.03	1.52	37	-1.7	25	17	11	-	-	-	
		400	106	-0.12	-			2.03	50	-3.0	28	22	18	-	-	-	
		500	132	-0.19	-			2.54	62	-4.7	30	26	24	13	-	-	
		600	159	-0.27	11			3.05	75	-6.7	32	30	28	18	-	-	
		700	185	-0.37	15			3.56	87	-9.2	33	32	31	23	12	-	
		800	211	-0.48	19			4.06	100	-12.0	34	35	35	27	17	12	
		1000	264	-0.75	25			5.08	125	-18.7	36	39	40	34	24	19	
		1200	317	-1.08	30			6.10	150	-27.0	38	42	44	39	31	26	
		1400	370	-1.47	35			7.11	175	-36.7	40	45	48	44	36	31	
10" x 6"	0.42	300	101	-0.07	-	254 x 152	0.04	1.52	48	-1.7	27	19	13	-	-	-	
		400	135	-0.12	-			2.03	64	-3.0	30	24	20	-	-	-	
		500	169	-0.19	-			2.54	80	-4.7	32	28	25	15	-	-	
		600	202	-0.27	13			3.05	95	-6.7	33	31	29	20	-	-	
		700	236	-0.37	17			3.56	111	-9.2	35	34	33	25	15	-	
		800	270	-0.48	21			4.06	127	-12.0	36	37	36	29	19	15	
		1000	337	-0.75	27			5.08	159	-18.7	38	41	41	36	27	22	
		1200	405	-1.08	32			6.10	191	-27.0	40	44	46	42	33	28	
		1300	438	-1.27	34			6.60	207	-31.6	41	45	48	44	36	31	
8" x 8"	0.44	300	110	-0.07	-	203 x 203	0.04	1.52	52	-1.7	27	20	13	-	-	-	
		400	146	-0.12	-			2.03	69	-3.0	30	25	20	-	-	-	
		500	183	-0.19	-			2.54	86	-4.7	32	29	26	15	-	-	
		600	219	-0.27	13			3.05	103	-6.7	34	32	30	21	-	-	
		700	256	-0.37	18			3.56	121	-9.2	35	35	33	26	16	11	
		800	292	-0.48	21			4.06	138	-12.0	37	37	37	30	20	15	
		1000	365	-0.75	28			5.08	172	-18.7	39	41	42	37	28	23	
		1200	438	-1.08	33			6.10	207	-27.0	40	44	46	42	34	29	
		1300	475	-1.27	35			6.60	224	-31.6	41	46	48	45	37	32	
12" x 6"	0.50	300	123	-0.07	-	305 x 152	0.05	1.52	58	-1.7	28	21	14	-	-	-	
		400	164	-0.12	-			2.03	77	-3.0	31	26	21	-	-	-	
		500	205	-0.19	-			2.54	97	-4.7	33	30	26	16	-	-	
		600	246	-0.27	14			3.05	116	-6.7	35	33	31	22	12	-	
		700	287	-0.37	18			3.56	136	-9.2	36	36	34	27	17	12	
		800	328	-0.48	22			4.06	155	-12.0	38	38	37	31	22	17	
		1000	410	-0.75	28			5.08	194	-18.7	40	42	43	38	29	24	
		1100	451	-0.91	31			5.59	213	-22.7	40	44	45	41	33	27	
		1200	492	-1.08	33			6.10	232	-27.0	41	45	47	43	36	30	
14" x 6"	0.58	300	145	-0.07	-	356 x 152	0.05	1.52	68	-1.7	29	22	15	-	-	-	
		400	193	-0.12	-			2.03	91	-3.0	32	27	22	11	-	-	
		500	242	-0.19	-			2.54	114	-4.7	34	31	27	18	-	-	
		600	290	-0.27	15			3.05	137	-6.7	36	34	32	23	13	-	
		700	338	-0.37	20			3.56	160	-9.2	37	37	35	28	19	14	
		800	386	-0.48	23			4.06	182	-12.0	39	39	38	32	23	19	
		900	435	-0.61	27			4.57	205	-15.2	40	41	41	36	27	22	
		1100	531	-0.91	32			5.59	251	-22.7	42	45	46	42	34	29	
		1200	580	-1.08	35			6.10	274	-27.0	42	47	48	45	37	32	

NOTES: NC values are based on octave band 2 - 7 sound power levels minus a room absorption of 10dB, re 10⁻¹² Watts. Dash in space denotes a NC or dB value of less than 10. Data was obtained from tests conducted in accordance with ANSI/ASHRAE Standard 70, ISO Standard 5219, and ISO Standard 3741. See Krueger's selection program for performance data not shown, including octave band data.

S80 / S580 / S85 / S585 SERIES



Return Grille | Single, Fixed Deflection

PERFORMANCE DATA | S80, S580 | 35° DEFLECTION (NO DAMPER)

		IP DATA				NC	METRIC DATA					OCTAVE BAND, dB						
NOM DUCT	DUCT AREA	NECK VEL	AIRFLOW	Ps	NOM DUCT		DUCT AREA	NECK VEL	AIRFLOW	Ps	2	3	4	5	6	7		
in	ft ²	FPM	CFM	"WG	mm		m ²	m/s	L/s	Pa								
12" x 8"	0.67	300	170	-0.07	-	305 x 203	0.06	1.52	80	-1.7	31	23	16	-	-	-		
		400	227	-0.12	-			2.03	107	-3.0	33	28	23	12	-	-		
		500	283	-0.19	11			2.54	134	-4.7	35	32	28	19	-	-		
		600	340	-0.27	16			3.05	160	-6.7	37	35	33	25	15	11		
		700	396	-0.37	21			3.56	187	-9.2	39	38	36	29	21	16		
		800	453	-0.48	24			4.06	214	-12.0	40	41	39	34	25	20		
		1000	566	-0.75	31			5.08	267	-18.7	42	45	45	40	33	28		
		1100	623	-0.91	33			5.59	294	-22.7	43	46	47	43	36	31		
		1200	680	-1.08	36			6.10	321	-27.0	44	48	49	46	39	34		
		10" x 10"	0.69	300	178			-0.07	-	254 x 254	0.06	1.52	84	-1.7	31	23	17	-
400	238			-0.12	-	2.03	112	-3.0	34			29	23	13	-	-		
500	297			-0.19	12	2.54	140	-4.7	36			33	29	20	-	-		
600	357			-0.27	17	3.05	168	-6.7	37			36	33	25	16	11		
700	416			-0.37	21	3.56	196	-9.2	39			39	36	30	21	16		
800	475			-0.48	25	4.06	224	-12.0	40			41	40	34	26	21		
1000	594			-0.75	31	5.08	280	-18.7	42			45	45	41	33	28		
1100	654			-0.91	34	5.59	308	-22.7	43			47	47	44	37	32		
1200	713			-1.08	36	6.10	337	-27.0	44			48	49	46	40	35		
18" x 6"	0.75			300	189	-0.07	-	457 x 152	0.07			1.52	89	-1.7	31	24	17	-
		400	252	-0.12	-	2.03	119			-3.0	34	29	24	13	-	-		
		500	314	-0.19	12	2.54	148			-4.7	36	33	29	20	-	-		
		600	377	-0.27	17	3.05	178			-6.7	38	36	33	26	16	12		
		700	440	-0.37	21	3.56	208			-9.2	39	39	37	30	22	17		
		800	503	-0.48	25	4.06	237			-12.0	41	41	40	34	26	21		
		1000	629	-0.75	31	5.08	297			-18.7	43	45	45	41	34	29		
		1100	692	-0.91	34	5.59	326			-22.7	44	47	47	44	37	32		
		1200	755	-1.08	36	6.10	356			-27.0	44	49	50	47	40	35		
		12" x 10"	0.83	300	217	-0.07	-			305 x 254	0.08	1.52	102	-1.7	32	25	18	-
400	289			-0.12	-	2.03	136	-3.0	35			30	25	14	-	-		
500	361			-0.19	13	2.54	171	-4.7	37			34	30	21	12	-		
600	434			-0.27	18	3.05	205	-6.7	39			37	34	27	18	13		
700	506			-0.37	22	3.56	239	-9.2	40			40	38	32	23	18		
800	578			-0.48	26	4.06	273	-12.0	42			42	41	36	28	23		
1000	723			-0.75	32	5.08	341	-18.7	44			46	46	42	36	31		
1100	795			-0.91	35	5.59	375	-22.7	45			48	48	45	39	34		
1200	867			-1.08	37	6.10	409	-27.0	45			50	50	48	42	37		
22" x 6"	0.92			300	232	-0.07	-	559 x 152	0.09			1.52	110	-1.7	33	25	18	-
		400	310	-0.12	-	2.03	146			-3.0	36	31	25	15	-	-		
		500	387	-0.19	13	2.54	183			-4.7	38	35	30	22	12	-		
		600	465	-0.27	19	3.05	219			-6.7	39	38	35	27	19	14		
		700	542	-0.37	23	3.56	256			-9.2	41	41	38	32	24	19		
		800	620	-0.48	27	4.06	293			-12.0	42	43	41	36	29	24		
		1000	775	-0.75	33	5.08	366			-18.7	44	47	47	43	36	31		
		1100	852	-0.91	36	5.59	402			-22.7	45	49	49	46	40	35		
		1200	930	-1.08	38	6.10	439			-27.0	46	50	51	49	43	37		
		12" x 12"	1.00	300	264	-0.07	-			305 x 305	0.09	1.52	124	-1.7	34	26	19	-
400	352			-0.12	-	2.03	166	-3.0	36			32	26	16	-	-		
500	439			-0.19	14	2.54	207	-4.7	39			36	31	23	14	-		
600	527			-0.27	19	3.05	249	-6.7	40			39	35	28	20	15		
700	615			-0.37	24	3.56	290	-9.2	42			42	39	33	25	21		
800	703			-0.48	28	4.06	332	-12.0	43			44	42	37	30	25		
900	791			-0.61	31	4.57	373	-15.2	44			46	45	41	34	29		
1000	879			-0.75	34	5.08	415	-18.7	45			48	47	44	38	33		
1100	967			-0.91	36	5.59	456	-22.7	46			50	50	47	41	36		

NOTES: NC values are based on octave band 2 - 7 sound power levels minus a room absorption of 10dB, re 10⁻¹² Watts. Dash in space denotes a NC or dB value of less than 10. Data was obtained from tests conducted in accordance with ANSI/ASHRAE Standard 70, ISO Standard 5219, and ISO Standard 3741. See Krueger's selection program for performance data not shown, including octave band data.

PERFORMANCE DATA | S80, S580 | 35° DEFLECTION (NO DAMPER)

IP DATA					NC	METRIC DATA					OCTAVE BAND, dB						
NOM DUCT	DUCT AREA	NECK VEL	AIRFLOW	Ps		NOM DUCT	DUCT AREA	NECK VEL	AIRFLOW	Ps	OCTAVE BAND, dB						
in	ft ²	FPM	CFM	"WG		mm	m ²	m/s	L/s	Pa	2	3	4	5	6	7	
18" x 10"	1.25	300	332	-0.07	-	457 x 254	0.12	1.52	157	-1.7	35	28	20	-	-	-	
		400	443	-0.12	-			2.03	209	-3.0	38	33	27	18	-	-	
		500	554	-0.19	16			2.54	261	-4.7	40	37	32	25	16	12	
		600	665	-0.27	21			3.05	314	-6.7	42	41	37	30	23	18	
		700	776	-0.37	25			3.56	366	-9.2	43	43	40	35	28	23	
		800	886	-0.48	29			4.06	418	-12.0	45	46	44	39	33	28	
		900	997	-0.61	32			4.57	471	-15.2	46	48	46	43	37	32	
		1000	1108	-0.75	35			5.08	523	-18.7	47	50	49	46	40	35	
		1100	1219	-0.91	38			5.59	575	-22.7	48	51	51	49	44	38	
14" x 14"	1.36	300	366	-0.07	-	356 x 356	0.13	1.52	173	-1.7	36	29	21	-	-	-	
		400	488	-0.12	-			2.03	230	-3.0	39	34	28	19	-	-	
		500	610	-0.19	17			2.54	288	-4.7	41	38	33	26	18	13	
		600	732	-0.27	22			3.05	345	-6.7	43	41	37	31	24	19	
		700	853	-0.37	26			3.56	403	-9.2	44	44	41	36	29	24	
		800	975	-0.48	30			4.06	460	-12.0	45	46	44	40	34	29	
		900	1097	-0.61	33			4.57	518	-15.2	46	49	47	44	38	33	
		1000	1219	-0.75	36			5.08	575	-18.7	47	50	49	47	42	36	
		1100	1341	-0.91	39			5.59	633	-22.7	48	52	52	50	45	40	
27" x 8"	1.50	300	396	-0.07	-	686 x 203	0.14	1.52	187	-1.7	37	30	21	11	-	-	
		400	529	-0.12	11			2.03	249	-3.0	39	35	28	19	11	-	
		500	661	-0.19	17			2.54	312	-4.7	41	39	34	26	18	14	
		600	793	-0.27	22			3.05	374	-6.7	43	42	38	32	25	20	
		700	925	-0.37	27			3.56	437	-9.2	45	45	41	37	30	25	
		800	1057	-0.48	30			4.06	499	-12.0	46	47	45	41	35	30	
		900	1189	-0.61	34			4.57	561	-15.2	47	49	47	44	39	34	
		1000	1322	-0.75	37			5.08	624	-18.7	48	51	50	48	42	37	
		1100	1454	-0.91	39			5.59	686	-22.7	49	53	52	50	46	40	
22" x 10"	1.53	300	410	-0.07	-	559 x 254	0.14	1.52	193	-1.7	37	30	22	11	-	-	
		400	546	-0.12	11			2.03	258	-3.0	40	35	28	20	11	-	
		500	683	-0.19	18			2.54	322	-4.7	42	39	34	27	19	14	
		600	819	-0.27	23			3.05	387	-6.7	43	42	38	32	25	20	
		700	956	-0.37	27			3.56	451	-9.2	45	45	42	37	30	26	
		800	1092	-0.48	31			4.06	515	-12.0	46	47	45	41	35	30	
		900	1229	-0.61	34			4.57	580	-15.2	47	49	48	45	39	34	
		1000	1365	-0.75	37			5.08	644	-18.7	48	51	50	48	43	38	
		1100	1502	-0.91	40			5.59	709	-22.7	49	53	52	51	46	41	
24" x 10"	1.67	200	299	-0.03	-	610 x 254	0.15	1.02	141	-0.7	34	23	13	-	-	-	
		300	448	-0.07	-			1.52	211	-1.7	37	30	22	12	-	-	
		400	597	-0.12	12			2.03	282	-3.0	40	36	29	21	12	-	
		500	747	-0.19	18			2.54	352	-4.7	42	40	34	27	20	15	
		600	896	-0.27	23			3.05	423	-6.7	44	43	39	33	26	21	
		700	1045	-0.37	28			3.56	493	-9.2	45	46	42	38	31	27	
		800	1195	-0.48	31			4.06	564	-12.0	47	48	45	42	36	31	
		900	1344	-0.61	35			4.57	634	-15.2	48	50	48	45	40	35	
		1000	1493	-0.75	38			5.08	705	-18.7	49	52	51	49	44	39	
18" x 14"	1.75	200	317	-0.03	-	457 x 356	0.16	1.02	150	-0.7	34	24	13	-	-	-	
		300	476	-0.07	-			1.52	225	-1.7	38	31	23	12	-	-	
		400	635	-0.12	12			2.03	300	-3.0	41	36	29	21	13	-	
		500	794	-0.19	19			2.54	375	-4.7	43	40	35	28	21	16	
		600	952	-0.27	24			3.05	449	-6.7	44	43	39	33	27	22	
		700	1111	-0.37	28			3.56	524	-9.2	46	46	43	38	32	27	
		800	1270	-0.48	32			4.06	599	-12.0	47	48	46	42	37	32	
		900	1429	-0.61	35			4.57	674	-15.2	48	51	49	46	41	36	
		1000	1587	-0.75	38			5.08	749	-18.7	49	52	51	49	45	39	

NOTES: NC values are based on octave band 2 - 7 sound power levels minus a room absorption of 10dB, re 10⁻¹² Watts. Dash in space denotes a NC or dB value of less than 10. Data was obtained from tests conducted in accordance with ANSI/ASHRAE Standard 70, ISO Standard 5219, and ISO Standard 3741. See Krueger's selection program for performance data not shown, including octave band data.

S80 / S580 / S85 / S585 SERIES



Return Grille | Single, Fixed Deflection

PERFORMANCE DATA | S80, S580 | 35° DEFLECTION (NO DAMPER)

NOM DUCT in	DUCT AREA ft ²	IP DATA				NC	METRIC DATA					OCTAVE BAND, dB						
		NECK VEL	AIRFLOW	Ps	NOM DUCT mm		DUCT AREA m ²	NECK VEL m/s	AIRFLOW L/s	Ps Pa	2	3	4	5	6	7		
		FPM	CFM	"WG														
16" x 16"	1.78	200	323	-.003	-	406 x 406	0.17	1.02	152	-0.7	34	24	13	-	-	-		
		300	485	-.007	-			1.52	229	-1.7	38	31	23	12	-	-		
		400	646	-.012	12			2.03	305	-3.0	41	36	30	21	13	-		
		500	808	-.019	19			2.54	381	-4.7	43	40	35	28	21	16		
		600	969	-.027	24			3.05	457	-6.7	45	43	39	34	27	22		
		700	1131	-.037	28			3.56	534	-9.2	46	46	43	38	32	27		
		800	1292	-.048	32			4.06	610	-12.0	47	49	46	42	37	32		
		900	1454	-.061	35			4.57	686	-15.2	48	51	49	46	41	36		
		1000	1615	-.075	38			5.08	762	-18.7	49	53	51	49	45	39		
		24" x 12"	2.00	200	363			-.003	-	610 x 305	0.19	1.02	171	-0.7	35	25	14	-
300	545			-.007	-	1.52	257	-1.7	39			32	23	13	-	-		
400	727			-.012	13	2.03	343	-3.0	42			37	30	22	14	-		
500	908			-.019	20	2.54	429	-4.7	44			41	36	29	22	17		
600	1090			-.027	25	3.05	514	-6.7	45			44	40	35	28	24		
700	1271			-.037	29	3.56	600	-9.2	47			47	43	39	34	29		
800	1453			-.048	33	4.06	686	-12.0	48			50	47	43	38	33		
900	1635			-.061	36	4.57	772	-15.2	49			52	49	47	42	37		
1000	1816			-.075	39	5.08	857	-18.7	50			53	52	50	46	41		
18" x 18"	2.25			200	413	-.003	-	457 x 457	0.21			1.02	195	-0.7	36	26	15	-
		300	620	-.007	-	1.52	293			-1.7	40	33	24	14	-	-		
		400	827	-.012	14	2.03	390			-3.0	43	38	31	23	16	11		
		500	1033	-.019	20	2.54	488			-4.7	45	42	36	30	24	19		
		600	1240	-.027	26	3.05	585			-6.7	46	45	41	36	30	25		
		700	1446	-.037	30	3.56	683			-9.2	48	48	44	40	35	30		
		800	1653	-.048	34	4.06	780			-12.0	49	50	47	44	40	35		
		900	1860	-.061	37	4.57	878			-15.2	50	53	50	48	44	39		
		1000	2066	-.075	40	5.08	975			-18.7	51	54	53	51	47	42		
		24" x 14"	2.33	200	428	-.003	-			610 x 356	0.22	1.02	202	-0.7	36	26	15	-
300	642			-.007	-	1.52	303	-1.7	40			33	24	15	-	-		
400	856			-.012	14	2.03	404	-3.0	43			38	31	24	16	12		
500	1070			-.019	21	2.54	505	-4.7	45			42	37	30	24	19		
600	1284			-.027	26	3.05	606	-6.7	47			46	41	36	30	25		
700	1498			-.037	30	3.56	707	-9.2	48			48	44	41	36	31		
800	1711			-.048	34	4.06	808	-12.0	49			51	48	45	40	35		
900	1925			-.061	37	4.57	909	-15.2	50			53	50	48	44	39		
1000	2139			-.075	40	5.08	1010	-18.7	51			55	53	52	48	43		
30" x 12"	2.50			200	457	-.003	-	762 x 305	0.23			1.02	216	-0.7	37	27	15	-
		300	686	-.007	-	1.52	324			-1.7	41	34	25	15	-	-		
		400	914	-.012	15	2.03	431			-3.0	43	39	32	24	17	12		
		500	1143	-.019	21	2.54	539			-4.7	45	43	37	31	25	20		
		600	1371	-.027	26	3.05	647			-6.7	47	46	41	37	31	26		
		700	1600	-.037	31	3.56	755			-9.2	48	49	45	41	36	31		
		800	1828	-.048	34	4.06	863			-12.0	50	51	48	45	41	36		
		900	2057	-.061	38	4.57	971			-15.2	51	53	51	49	45	40		
		1000	2285	-.075	41	5.08	1078			-18.7	52	55	53	52	49	43		
		24" x 16"	2.67	200	492	-.003	-			610 x 406	0.25	1.02	232	-0.7	37	27	16	-
300	739			-.007	-	1.52	349	-1.7	41			34	25	16	-	-		
400	985			-.012	15	2.03	465	-3.0	44			39	32	25	18	13		
500	1231			-.019	22	2.54	581	-4.7	46			43	37	32	25	21		
600	1477			-.027	27	3.05	697	-6.7	48			47	42	37	32	27		
700	1724			-.037	31	3.56	813	-9.2	49			49	45	42	37	32		
800	1970			-.048	35	4.06	930	-12.0	50			52	48	46	42	37		
900	2216			-.061	38	4.57	1046	-15.2	51			54	51	50	46	41		
1000	2462			-.075	41	5.08	1162	-18.7	52			56	54	53	49	44		

NOTES: NC values are based on octave band 2 - 7 sound power levels minus a room absorption of 10dB, re 10⁻¹² Watts. Dash in space denotes a NC or dB value of less than 10. Data was obtained from tests conducted in accordance with ANSI/ASHRAE Standard 70, ISO Standard 5219, and ISO Standard 3741. See Krueger's selection program for performance data not shown, including octave band data.

PERFORMANCE DATA | S80, S580 | 35° DEFLECTION (NO DAMPER)

		IP DATA				NC	METRIC DATA					OCTAVE BAND, dB						
NOM DUCT	DUCT AREA	NECK VEL	AIRFLOW	Ps	NOM DUCT		DUCT AREA	NECK VEL	AIRFLOW	Ps								
in	ft ²	FPM	CFM	"WG	mm		m ²	m/s	L/s	Pa	2	3	4	5	6	7		
20" x 20"	2.78	200	515	-0.03	-	508 x 508	0.26	1.02	243	-0.7	38	27	16	-	-	-		
		300	772	-0.07	-			1.52	364	-1.7	41	35	26	16	-	-		
		400	1029	-0.12	16			2.03	486	-3.0	44	40	32	25	18	14		
		500	1287	-0.19	22			2.54	607	-4.7	46	44	38	32	26	21		
		600	1544	-0.27	27			3.05	729	-6.7	48	47	42	38	32	27		
		700	1801	-0.37	31			3.56	850	-9.2	49	50	46	42	38	33		
		800	2059	-0.48	35			4.06	972	-12.0	51	52	49	46	42	37		
		900	2316	-0.61	38			4.57	1093	-15.2	52	54	52	50	46	41		
		1000	2573	-0.75	41			5.08	1214	-18.7	53	56	54	53	50	45		
		24" x 18"	3.00	200	557			-0.03	-	610 x 457	0.28	1.02	263	-0.7	34	23	13	-
300	836			-0.07	-	1.52	394	-1.7	37			30	22	12	-	-		
400	1114			-0.12	16	2.03	526	-3.0	40			36	29	21	12	-		
500	1393			-0.19	23	2.54	657	-4.7	42			40	34	27	20	15		
600	1671			-0.27	28	3.05	789	-6.7	44			43	39	33	26	21		
700	1950			-0.37	32	3.56	920	-9.2	45			46	42	38	31	27		
800	2228			-0.48	36	4.06	1052	-12.0	47			48	45	42	36	31		
900	2507			-0.61	39	4.57	1183	-15.2	48			50	48	45	40	35		
1000	2785			-0.75	42	5.08	1314	-18.7	49			52	51	49	44	39		
30" x 16"	3.33			200	620	-0.03	-	762 x 406	0.31			1.02	292	-0.7	34	24	13	-
		300	929	-0.07	-	1.52	439			-1.7	38	31	23	12	-	-		
		400	1239	-0.12	17	2.03	585			-3.0	41	36	29	21	13	-		
		500	1549	-0.19	23	2.54	731			-4.7	43	40	35	28	21	16		
		600	1859	-0.27	28	3.05	877			-6.7	44	43	39	33	27	22		
		700	2168	-0.37	33	3.56	1023			-9.2	46	46	43	38	32	27		
		800	2478	-0.48	36	4.06	1170			-12.0	47	48	46	42	37	32		
		900	2788	-0.61	40	4.57	1316			-15.2	48	51	49	46	41	36		
		1000	3098	-0.75	43	5.08	1462			-18.7	49	52	51	49	45	39		
		22" x 22"	3.36	200	627	-0.03	-			559 x 559	0.31	1.02	296	-0.7	39	29	17	-
400	1254			-0.12	17	2.03	592	-3.0	45			41	34	27	21	16		
500	1568			-0.19	23	2.54	740	-4.7	48			45	39	34	28	23		
600	1882			-0.27	29	3.05	888	-6.7	49			49	43	39	35	30		
700	2195			-0.37	33	3.56	1036	-9.2	51			51	47	44	40	35		
800	2509			-0.48	37	4.06	1184	-12.0	52			54	50	48	44	39		
900	2822			-0.61	40	4.57	1332	-15.2	53			56	53	52	49	43		
1000	3136			-0.75	43	5.08	1480	-18.7	54			58	55	55	52	47		
1100	3449			-0.91	45	5.59	1628	-22.7	55			59	58	58	56	50		
36" x 14"	3.50			200	649	-0.03	-	914 x 356	0.33			1.02	306	-0.7	39	29	18	-
		400	1297	-0.12	17	2.03	612			-3.0	46	42	34	27	21	16		
		500	1622	-0.19	24	2.54	765			-4.7	48	46	39	34	29	24		
		600	1946	-0.27	29	3.05	918			-6.7	50	49	43	39	35	30		
		700	2270	-0.37	33	3.56	1072			-9.2	51	52	47	44	40	35		
		800	2595	-0.48	37	4.06	1225			-12.0	52	54	50	48	45	40		
		900	2919	-0.61	40	4.57	1378			-15.2	53	56	53	52	49	44		
		1000	3243	-0.75	43	5.08	1531			-18.7	54	58	55	55	53	47		
		1100	3568	-0.91	46	5.59	1684			-22.7	55	60	58	58	56	50		
		24" x 22"	3.67	200	686	-0.03	-			610 x 559	0.34	1.02	324	-0.7	40	30	18	-
400	1372			-0.12	18	2.03	648	-3.0	46			42	34	28	22	17		
500	1715			-0.19	24	2.54	810	-4.7	48			46	39	34	29	24		
600	2059			-0.27	29	3.05	972	-6.7	50			49	44	40	36	31		
700	2402			-0.37	33	3.56	1133	-9.2	51			52	47	45	41	36		
800	2745			-0.48	37	4.06	1295	-12.0	53			54	51	49	46	40		
900	3088			-0.61	41	4.57	1457	-15.2	54			56	53	52	50	44		
1000	3431			-0.75	43	5.08	1619	-18.7	55			58	56	56	53	48		
1100	3774			-0.91	46	5.59	1781	-22.7	56			60	58	59	57	51		

NOTES: NC values are based on octave band 2 - 7 sound power levels minus a room absorption of 10dB, re 10⁻¹² Watts. Dash in space denotes a NC or dB value of less than 10. Data was obtained from tests conducted in accordance with ANSI/ASHRAE Standard 70, ISO Standard 5219, and ISO Standard 3741. See Krueger's selection program for performance data not shown, including octave band data.

S80 / S580 / S85 / S585 SERIES



Return Grille | Single, Fixed Deflection

PERFORMANCE DATA | S80, S580 | 35° DEFLECTION (NO DAMPER)

		IP DATA				NC	METRIC DATA					OCTAVE BAND, dB						
NOM DUCT	DUCT AREA	NECK VEL	AIRFLOW	Ps	NOM DUCT		DUCT AREA	NECK VEL	AIRFLOW	Ps	2	3	4	5	6	7		
in	ft ²	FPM	CFM	"WG	mm		m ²	m/s	L/s	Pa								
30" x 18"	3.75	200	701	-.003	-	762 x 457	0.35	1.02	331	-0.7	40	30	18	-	-	-		
		400	1402	-.012	18			2.03	661	-3.0	46	42	34	28	22	17		
		500	1752	-.019	24			2.54	827	-4.7	48	46	40	35	29	25		
		600	2102	-.027	29			3.05	992	-6.7	50	49	44	40	36	31		
		700	2453	-.037	34			3.56	1158	-9.2	52	52	48	45	41	36		
		800	2803	-.048	37			4.06	1323	-12.0	53	55	51	49	46	41		
		900	3154	-.061	41			4.57	1488	-15.2	54	57	53	53	50	44		
		1000	3504	-.075	44			5.08	1654	-18.7	55	59	56	56	53	48		
		1100	3854	-.091	46			5.59	1819	-22.7	56	60	58	59	57	51		
		36" x 16"	4.00	200	747			-.003	-	914 x 406	0.37	1.02	352	-0.7	40	30	18	-
400	1493			-.012	18	2.03	705	-3.0	47			43	35	28	22	18		
500	1867			-.019	25	2.54	881	-4.7	49			47	40	35	30	25		
600	2240			-.027	30	3.05	1057	-6.7	51			50	44	41	37	31		
700	2613			-.037	34	3.56	1233	-9.2	52			53	48	45	42	37		
800	2986			-.048	38	4.06	1409	-12.0	53			55	51	49	46	41		
900	3360			-.061	41	4.57	1586	-15.2	54			57	54	53	51	45		
1000	3733			-.075	44	5.08	1762	-18.7	55			59	56	56	54	49		
1100	4106			-.091	47	5.59	1938	-22.7	56			61	59	59	57	52		
36" x 18"	4.50			200	845	-.003	-	914 x 457	0.42			1.02	399	-0.7	41	31	19	-
		400	1689	-.012	19	2.03	797			-3.0	48	44	36	29	24	19		
		500	2111	-.019	26	2.54	996			-4.7	50	48	41	36	32	27		
		600	2534	-.027	31	3.05	1196			-6.7	51	51	45	42	38	33		
		700	2956	-.037	35	3.56	1395			-9.2	53	54	49	46	43	38		
		800	3378	-.048	39	4.06	1594			-12.0	54	56	52	51	48	43		
		900	3800	-.061	42	4.57	1794			-15.2	55	58	55	54	52	47		
		1000	4223	-.075	45	5.08	1993			-18.7	56	60	57	57	56	50		
		1100	4645	-.091	48	5.59	2192			-22.7	57	62	59	60	59	53		
		30" x 24"	5.00	200	945	-.003	-			762 x 610	0.46	1.02	446	-0.7	42	32	20	-
400	1889			-.012	20	2.03	892	-3.0	48			44	36	30	25	20		
500	2361			-.019	26	2.54	1114	-4.7	51			48	41	37	33	28		
600	2834			-.027	31	3.05	1337	-6.7	52			52	46	43	39	34		
700	3306			-.037	36	3.56	1560	-9.2	54			54	49	47	44	39		
800	3778			-.048	39	4.06	1783	-12.0	55			57	53	51	49	44		
900	4250			-.061	43	4.57	2006	-15.2	56			59	55	55	53	48		
1000	4723			-.075	46	5.08	2229	-18.7	57			61	58	58	57	51		
1100	5195			-.091	48	5.59	2452	-22.7	58			63	60	61	60	55		
42" x 18"	5.25			200	988	-.003	-	1067 x 457	0.49			1.02	466	-0.7	34	23	13	-
		400	1977	-.012	20	2.03	933			-3.0	40	36	29	21	12	-		
		500	2471	-.019	27	2.54	1166			-4.7	42	40	34	27	20	15		
		600	2965	-.027	32	3.05	1399			-6.7	44	43	39	33	26	21		
		700	3459	-.037	36	3.56	1632			-9.2	45	46	42	38	31	27		
		800	3953	-.048	40	4.06	1866			-12.0	47	48	45	42	36	31		
		900	4447	-.061	43	4.57	2099			-15.2	48	50	48	45	40	35		
		1000	4941	-.075	46	5.08	2332			-18.7	49	52	51	49	44	39		
		1100	5436	-.091	49	5.59	2565			-22.7	50	54	53	51	47	42		
		28" x 28"	5.44	200	1031	-.003	-			711 x 711	0.51	1.02	487	-0.7	34	24	13	-
400	2063			-.012	21	2.03	973	-3.0	41			36	29	21	13	-		
500	2578			-.019	27	2.54	1217	-4.7	43			40	35	28	21	16		
600	3094			-.027	32	3.05	1460	-6.7	44			43	39	33	27	22		
700	3610			-.037	36	3.56	1704	-9.2	46			46	43	38	32	27		
800	4125			-.048	40	4.06	1947	-12.0	47			48	46	42	37	32		
900	4641			-.061	43	4.57	2190	-15.2	48			51	49	46	41	36		
1000	5157			-.075	46	5.08	2434	-18.7	49			52	51	49	45	39		
1100	5672			-.091	49	5.59	2677	-22.7	50			54	53	52	48	42		

NOTES: NC values are based on octave band 2 - 7 sound power levels minus a room absorption of 10dB, re 10⁻¹² Watts. Dash in space denotes a NC or dB value of less than 10. Data was obtained from tests conducted in accordance with ANSI/ASHRAE Standard 70, ISO Standard 5219, and ISO Standard 3741. See Krueger's selection program for performance data not shown, including octave band data.

PERFORMANCE DATA | S80, S580 | 35° DEFLECTION (NO DAMPER)

IP DATA					NC	METRIC DATA					OCTAVE BAND, dB						
NOM DUCT	DUCT AREA	NECK VEL	AIRFLOW	Ps		NOM DUCT	DUCT AREA	NECK VEL	AIRFLOW	Ps	OCTAVE BAND, dB						
in	ft ²	FPM	CFM	"WG		mm	m ²	m/s	L/s	Pa	2	3	4	5	6	7	
30" x 28"	5.83	200	1107	-0.03	-	762 x 711	0.54	1.02	522	-0.7	43	33	21	-	-	-	
		400	2214	-0.12	21			2.03	1045	-3.0	50	46	37	32	27	22	
		500	2768	-0.19	27			2.54	1306	-4.7	52	50	42	38	35	30	
		600	3321	-0.27	33			3.05	1567	-6.7	53	53	47	44	41	36	
		700	3875	-0.37	37			3.56	1829	-9.2	55	56	50	49	46	41	
		800	4428	-0.48	41			4.06	2090	-12.0	56	58	54	53	51	46	
		900	4982	-0.61	44			4.57	2351	-15.2	57	60	56	56	55	50	
		1000	5535	-0.75	47			5.08	2612	-18.7	58	62	59	60	59	53	
		1100	6089	-0.91	50			5.59	2874	-22.7	59	64	61	63	62	56	
		36" x 24"	6.00	200	1138			-0.03	-	914 x 610	0.56	1.02	537	-0.7	43	34	21
400	2277			-0.12	21	2.03	1074	-3.0	50			46	37	32	27	22	
500	2846			-0.19	28	2.54	1343	-4.7	52			50	43	39	35	30	
600	3415			-0.27	33	3.05	1612	-6.7	54			53	47	44	41	36	
700	3984			-0.37	37	3.56	1880	-9.2	55			56	51	49	47	41	
800	4553			-0.48	41	4.06	2149	-12.0	56			58	54	53	51	46	
900	5122			-0.61	44	4.57	2417	-15.2	57			60	56	57	55	50	
1000	5691			-0.75	47	5.08	2686	-18.7	58			62	59	60	59	53	
1100	6261			-0.91	50	5.59	2955	-22.7	59			64	61	63	62	57	
30" x 30"	6.25			200	1188	-0.03	-	762 x 762	0.58			1.02	561	-0.7	44	34	21
		400	2377	-0.12	22	2.03	1122			-3.0	50	46	38	32	28	23	
		500	2971	-0.19	28	2.54	1402			-4.7	52	50	43	39	35	31	
		600	3565	-0.27	33	3.05	1682			-6.7	54	53	47	45	42	37	
		700	4159	-0.37	37	3.56	1963			-9.2	55	56	51	49	47	42	
		800	4753	-0.48	41	4.06	2243			-12.0	57	59	54	53	52	46	
		900	5347	-0.61	44	4.57	2524			-15.2	58	61	57	57	56	50	
		1000	5941	-0.75	47	5.08	2804			-18.7	59	63	59	60	59	54	
		1100	6536	-0.91	50	5.59	3084			-22.7	60	64	61	63	63	57	
		36" x 28"	7.00	200	1334	-0.03	-			914 x 711	0.65	1.02	630	-0.7	44	35	22
400	2668			-0.12	23	2.03	1259	-3.0	51			47	38	33	29	24	
500	3335			-0.19	29	2.54	1574	-4.7	53			51	44	40	37	32	
600	4002			-0.27	34	3.05	1889	-6.7	55			54	48	46	43	38	
700	4669			-0.37	38	3.56	2204	-9.2	56			57	52	50	48	43	
800	5336			-0.48	42	4.06	2519	-12.0	57			59	55	54	53	48	
900	6004			-0.61	45	4.57	2833	-15.2	59			62	57	58	57	52	
1000	6671			-0.75	48	5.08	3148	-18.7	59			63	60	61	61	55	
1100	7338			-0.91	51	5.59	3463	-22.7	60			65	62	64	64	58	
46" x 22"	7.03			200	1336	-0.03	-	1168 x 559	0.65			1.02	630	-0.7	44	35	22
		400	2671	-0.12	23	2.03	1261			-3.0	51	47	38	33	29	24	
		500	3339	-0.19	29	2.54	1576			-4.7	53	51	44	40	37	32	
		600	4007	-0.27	34	3.05	1891			-6.7	55	54	48	46	43	38	
		700	4674	-0.37	38	3.56	2206			-9.2	56	57	52	50	48	43	
		800	5342	-0.48	42	4.06	2521			-12.0	57	59	55	54	53	48	
		900	6010	-0.61	45	4.57	2836			-15.2	59	62	57	58	57	52	
		1000	6678	-0.75	48	5.08	3151			-18.7	60	63	60	61	61	55	
		1100	7345	-0.91	51	5.59	3467			-22.7	60	65	62	64	64	58	
		32" x 32"	7.11	200	1356	-0.03	-			813 x 813	0.66	1.02	640	-0.7	44	35	22
400	2713			-0.12	23	2.03	1280	-3.0	51			47	38	33	29	24	
500	3391			-0.19	29	2.54	1600	-4.7	53			51	44	40	37	32	
600	4069			-0.27	34	3.05	1920	-6.7	55			54	48	46	43	38	
700	4747			-0.37	38	3.56	2240	-9.2	56			57	52	50	49	43	
800	5425			-0.48	42	4.06	2560	-12.0	58			60	55	55	53	48	
900	6104			-0.61	45	4.57	2881	-15.2	59			62	58	58	57	52	
1000	6782			-0.75	48	5.08	3201	-18.7	60			64	60	61	61	55	
1100	7460			-0.91	51	5.59	3521	-22.7	61			65	62	64	64	59	

NOTES: NC values are based on octave band 2 - 7 sound power levels minus a room absorption of 10dB, re 10⁻¹² Watts. Dash in space denotes a NC or dB value of less than 10. Data was obtained from tests conducted in accordance with ANSI/ASHRAE Standard 70, ISO Standard 5219, and ISO Standard 3741. See Krueger's selection program for performance data not shown, including octave band data.

S80 / S580 / S85 / S585 SERIES



Return Grille | Single, Fixed Deflection

PERFORMANCE DATA | S80, S580 | 35° DEFLECTION (NO DAMPER)

		IP DATA				NC	METRIC DATA					OCTAVE BAND, dB						
NOM DUCT	DUCT AREA	NECK VEL	AIRFLOW	Ps	NOM DUCT		DUCT AREA	NECK VEL	AIRFLOW	Ps	2	3	4	5	6	7		
in	ft ²	FPM	CFM	"WG	mm	m ²	m/s	L/s	Pa									
36" x 30"	7.50	200	1432	-.003	-	914 x 762	0.70	1.02	676	-0.7	45	35	22	13	-	-		
		400	2864	-.012	23			2.03	1352	-3.0	51	48	39	34	30	25		
		500	3580	-.019	29			2.54	1690	-4.7	53	52	44	41	38	33		
		600	4296	-.027	34			3.05	2028	-6.7	55	55	48	46	44	39		
		700	5012	-.037	39			3.56	2365	-9.2	57	58	52	51	49	44		
		800	5728	-.048	42			4.06	2703	-12.0	58	60	55	55	54	48		
		900	6444	-.061	46			4.57	3041	-15.2	59	62	58	59	58	52		
		1000	7160	-.075	49			5.08	3379	-18.7	60	64	60	62	62	56		
		1100	7876	-.091	51			5.59	3717	-22.7	61	66	63	65	65	59		
		36" x 32"	8.00	200	1530			-.003	-	914 x 813	0.74	1.02	722	-0.7	34	23	13	-
400	3060			-.012	24	2.03	1444	-3.0	40			36	29	21	12	-		
500	3825			-.019	30	2.54	1805	-4.7	42			40	34	27	20	15		
600	4590			-.027	35	3.05	2166	-6.7	44			43	39	33	26	21		
700	5355			-.037	39	3.56	2527	-9.2	45			46	42	38	31	27		
800	6120			-.048	43	4.06	2888	-12.0	47			48	45	42	36	31		
900	6885			-.061	46	4.57	3249	-15.2	48			50	48	45	40	35		
1000	7650			-.075	49	5.08	3610	-18.7	49			52	51	49	44	39		
1100	8415			-.091	52	5.59	3971	-22.7	50			54	53	51	47	42		
34" x 34"	8.03			200	1536	-.003	-	864 x 864	0.75			1.02	725	-0.7	34	24	13	-
		400	3071	-.012	24	2.03	1449			-3.0	41	36	29	21	13	-		
		500	3839	-.019	30	2.54	1812			-4.7	43	40	35	28	21	16		
		600	4607	-.027	35	3.05	2174			-6.7	44	43	39	33	27	22		
		700	5374	-.037	39	3.56	2536			-9.2	46	46	43	38	32	27		
		800	6142	-.048	43	4.06	2899			-12.0	47	48	46	42	37	32		
		900	6910	-.061	46	4.57	3261			-15.2	48	51	49	46	41	36		
		1000	7678	-.075	49	5.08	3623			-18.7	49	52	51	49	45	39		
		1100	8445	-.091	52	5.59	3986			-22.7	50	54	53	52	48	42		
		36" x 34"	8.50	200	1628	-.003	-			914 x 864	0.79	1.02	768	-0.7	46	36	23	14
400	3256			-.012	24	2.03	1537	-3.0	52			49	40	35	31	26		
500	4070			-.019	30	2.54	1921	-4.7	54			53	45	42	39	34		
600	4884			-.027	35	3.05	2305	-6.7	56			56	49	47	45	40		
700	5698			-.037	40	3.56	2689	-9.2	58			59	53	52	51	45		
800	6511			-.048	43	4.06	3073	-12.0	59			61	56	56	55	50		
900	7325			-.061	47	4.57	3457	-15.2	60			63	59	60	59	54		
1000	8139			-.075	50	5.08	3841	-18.7	61			65	61	63	63	57		
1100	8953			-.091	52	5.59	4225	-22.7	62			67	63	66	66	61		
42" x 30"	8.75			200	1676	-.003	-	1067 x 762	0.81			1.02	791	-0.7	46	36	23	14
		400	3352	-.012	24	2.03	1582			-3.0	53	49	40	35	32	27		
		500	4189	-.019	30	2.54	1977			-4.7	55	53	45	42	39	34		
		600	5027	-.027	36	3.05	2373			-6.7	56	56	49	48	46	40		
		700	5865	-.037	40	3.56	2768			-9.2	58	59	53	52	51	46		
		800	6703	-.048	44	4.06	3164			-12.0	59	61	56	56	56	50		
		900	7541	-.061	47	4.57	3559			-15.2	60	63	59	60	60	54		
		1000	8379	-.075	50	5.08	3954			-18.7	61	65	61	63	63	58		
		1100	9217	-.091	52	5.59	4350			-22.7	62	67	64	66	67	61		
		36" x 36"	9.00	200	1726	-.003	-			914 x 914	0.84	1.02	814	-0.7	46	37	24	14
400	3452			-.012	24	2.03	1629	-3.0	53			49	40	35	32	27		
500	4314			-.019	31	2.54	2036	-4.7	55			53	45	42	40	35		
600	5177			-.027	36	3.05	2443	-6.7	57			56	50	48	46	41		
700	6040			-.037	40	3.56	2851	-9.2	58			59	53	52	51	46		
800	6903			-.048	44	4.06	3258	-12.0	59			61	56	57	56	51		
900	7766			-.061	47	4.57	3665	-15.2	60			64	59	60	60	54		
1000	8629			-.075	50	5.08	4072	-18.7	61			65	62	63	64	58		
1100	9492			-.091	53	5.59	4480	-22.7	62			67	64	66	67	61		

NOTES: NC values are based on octave band 2 - 7 sound power levels minus a room absorption of 10dB, re 10⁻¹² Watts. Dash in space denotes a NC or dB value of less than 10. Data was obtained from tests conducted in accordance with ANSI/ASHRAE Standard 70, ISO Standard 5219, and ISO Standard 3741. See Krueger's selection program for performance data not shown, including octave band data.

PERFORMANCE DATA | S80, S580 | 35° DEFLECTION (NO DAMPER)

		IP DATA				NC	METRIC DATA					OCTAVE BAND, dB						
NOM DUCT	DUCT AREA	NECK VEL	AIRFLOW	Ps	NOM DUCT		DUCT AREA	NECK VEL	AIRFLOW	Ps								
in	ft ²	FPM	CFM	"WG	mm		m ²	m/s	L/s	Pa	2	3	4	5	6	7		
48" x 30"	10.00	200	1920	-0.03	-	1219 x 762	0.93	1.02	906	-0.7	47	38	24	15	-	-		
		400	3839	-0.12	25			2.03	1812	-3.0	53	50	41	36	33	28		
		500	4799	-0.19	31			2.54	2265	-4.7	56	54	46	43	41	36		
		600	5759	-0.27	36			3.05	2718	-6.7	57	57	50	49	47	42		
		700	6718	-0.37	41			3.56	3171	-9.2	59	60	54	53	53	47		
		800	7678	-0.48	45			4.06	3624	-12.0	60	62	57	57	57	52		
		900	8638	-0.61	48			4.57	4077	-15.2	61	64	60	61	61	56		
		1000	9598	-0.75	51			5.08	4530	-18.7	62	66	62	64	65	59		
		1100	10557	-0.91	53			5.59	4983	-22.7	63	68	64	67	68	62		
38" x 38"	10.03	200	1927	-0.03	-	965 x 965	0.93	1.02	910	-0.7	47	38	24	15	-	-		
		400	3854	-0.12	25			2.03	1819	-3.0	53	50	41	36	33	28		
		500	4818	-0.19	31			2.54	2274	-4.7	56	54	46	43	41	36		
		600	5782	-0.27	37			3.05	2729	-6.7	57	57	50	49	47	42		
		700	6745	-0.37	41			3.56	3183	-9.2	59	60	54	53	53	47		
		800	7709	-0.48	45			4.06	3638	-12.0	60	62	57	58	57	52		
		900	8672	-0.61	48			4.57	4093	-15.2	61	64	60	61	61	56		
		1000	9636	-0.75	51			5.08	4548	-18.7	62	66	62	64	65	59		
		1100	10599	-0.91	53			5.59	5002	-22.7	63	68	64	67	68	62		
42" x 36"	10.50	200	2020	-0.03	-	1067 x 914	0.98	1.02	953	-0.7	47	38	25	15	-	-		
		400	4039	-0.12	26			2.03	1906	-3.0	54	50	41	37	34	29		
		500	5049	-0.19	32			2.54	2383	-4.7	56	54	46	44	41	36		
		600	6059	-0.27	37			3.05	2859	-6.7	58	58	51	49	48	43		
		700	7068	-0.37	41			3.56	3336	-9.2	59	60	54	54	53	48		
		800	8078	-0.48	45			4.06	3812	-12.0	60	63	57	58	58	52		
		900	9088	-0.61	48			4.57	4289	-15.2	61	65	60	62	62	56		
		1000	10098	-0.75	51			5.08	4766	-18.7	62	67	63	65	65	60		
		1100	11107	-0.91	54			5.59	5242	-22.7	63	68	65	68	69	63		
46" x 34"	10.86	200	2090	-0.03	-	1168 x 864	1.01	1.02	986	-0.7	48	38	25	16	-	-		
		400	4179	-0.12	26			2.03	1972	-3.0	54	51	41	37	34	29		
		500	5224	-0.19	32			2.54	2466	-4.7	56	55	46	44	42	37		
		600	6269	-0.27	37			3.05	2959	-6.7	58	58	51	49	48	43		
		700	7314	-0.37	41			3.56	3452	-9.2	59	61	54	54	53	48		
		800	8359	-0.48	45			4.06	3945	-12.0	61	63	57	58	58	53		
		900	9404	-0.61	48			4.57	4438	-15.2	62	65	60	62	62	57		
		1000	10448	-0.75	51			5.08	4931	-18.7	63	67	63	65	66	60		
		1100	11493	-0.91	54			5.59	5424	-22.7	64	69	65	68	69	63		
42" x 38"	11.08	200	2134	-0.03	-	1067 x 965	1.03	1.02	1007	-0.7	34	23	13	-	-	-		
		400	4268	-0.12	26			2.03	2014	-3.0	40	36	29	21	12	-		
		500	5335	-0.19	32			2.54	2518	-4.7	42	40	34	27	20	15		
		600	6402	-0.27	37			3.05	3022	-6.7	44	43	39	33	26	21		
		700	7469	-0.37	42			3.56	3525	-9.2	45	46	42	38	31	27		
		800	8536	-0.48	45			4.06	4029	-12.0	47	48	45	42	36	31		
		900	9604	-0.61	49			4.57	4532	-15.2	48	50	48	45	40	35		
		1000	10671	-0.75	52			5.08	5036	-18.7	49	52	51	49	44	39		
		1100	11738	-0.91	54			5.59	5540	-22.7	50	54	53	51	47	42		
40" x 40"	11.11	200	2140	-0.03	-	1016 x 1016	1.03	1.02	1010	-0.7	34	24	13	-	-	-		
		400	4279	-0.12	26			2.03	2020	-3.0	41	36	29	21	13	-		
		500	5349	-0.19	32			2.54	2525	-4.7	43	40	35	28	21	16		
		600	6419	-0.27	37			3.05	3029	-6.7	44	43	39	33	27	22		
		700	7489	-0.37	42			3.56	3534	-9.2	46	46	43	38	32	27		
		800	8559	-0.48	45			4.06	4039	-12.0	47	48	46	42	37	32		
		900	9629	-0.61	49			4.57	4544	-15.2	48	51	49	46	41	36		
		1000	10698	-0.75	52			5.08	5049	-18.7	49	52	51	49	45	39		
		1100	11768	-0.91	54			5.59	5554	-22.7	50	54	53	52	48	42		

NOTES: NC values are based on octave band 2 - 7 sound power levels minus a room absorption of 10dB, re 10⁻¹² Watts. Dash in space denotes a NC or dB value of less than 10. Data was obtained from tests conducted in accordance with ANSI/ASHRAE Standard 70, ISO Standard 5219, and ISO Standard 3741. See Krueger's selection program for performance data not shown, including octave band data.

GRILLES | RETURN

S80 / S580 / S85 / S585 SERIES



Return Grille | Single, Fixed Deflection

PERFORMANCE DATA | S80, S580 | 35° DEFLECTION (NO DAMPER)

		IP DATA				NC	METRIC DATA					OCTAVE BAND, dB						
NOM DUCT	DUCT AREA	NECK VEL	AIRFLOW	Ps	NOM DUCT		DUCT AREA	NECK VEL	AIRFLOW	Ps								
in	ft ²	FPM	CFM	"WG	mm		m ²	m/s	L/s	Pa	2	3	4	5	6	7		
48" x 36"	12.00	200	2313	-0.03	-	1219 x 914	1.11	1.02	1092	-0.7	48	39	25	17	11	-		
		350	4048	-0.09	23			1.78	1911	-2.3	54	49	39	34	31	26		
		400	4627	-0.12	26			2.03	2183	-3.0	55	51	42	38	35	30		
		500	5783	-0.19	33			2.54	2729	-4.7	57	55	47	45	43	38		
		600	6940	-0.27	38			3.05	3275	-6.7	59	59	51	50	49	44		
		700	8096	-0.37	42			3.56	3821	-9.2	60	61	55	55	55	49		
		800	9253	-0.48	46			4.06	4367	-12.0	61	64	58	59	59	54		
		900	10410	-0.61	49			4.57	4913	-15.2	62	66	61	63	63	58		
		1000	11566	-0.75	52			5.08	5459	-18.7	63	68	63	66	67	61		
		42" x 42"	12.25	200	2363			-0.03	-	1067 x 1067	1.14	1.02	1115	-0.7	48	39	26	17
350	4136			-0.09	23	1.78	1952	-2.3	54			49	39	34	31	26		
400	4727			-0.12	27	2.03	2231	-3.0	55			51	42	38	35	31		
500	5908			-0.19	33	2.54	2788	-4.7	57			55	47	45	43	38		
600	7090			-0.27	38	3.05	3346	-6.7	59			59	51	50	50	44		
700	8271			-0.37	42	3.56	3904	-9.2	60			61	55	55	55	49		
800	9453			-0.48	46	4.06	4461	-12.0	61			64	58	59	59	54		
900	10635			-0.61	49	4.57	5019	-15.2	63			66	61	63	64	58		
1000	11816			-0.75	52	5.08	5577	-18.7	64			68	64	66	67	62		
44" x 44"	13.44			200	2598	-0.03	-	1118 x 1118	1.25			1.02	1226	-0.7	49	40	26	18
		350	4547	-0.09	24	1.78	2146			-2.3	54	50	39	35	32	27		
		400	5196	-0.12	27	2.03	2452			-3.0	56	52	43	39	37	32		
		500	6495	-0.19	34	2.54	3065			-4.7	58	56	48	46	44	39		
		600	7794	-0.27	39	3.05	3678			-6.7	59	59	52	51	51	45		
		700	9093	-0.37	43	3.56	4291			-9.2	61	62	56	56	56	51		
		800	10392	-0.48	47	4.06	4904			-12.0	62	65	59	60	61	55		
		900	11691	-0.61	50	4.57	5518			-15.2	63	67	62	64	65	59		
		1000	12990	-0.75	53	5.08	6131			-18.7	64	69	64	67	68	63		
		48" x 42"	14.00	200	2707	-0.03	-			1219 x 1067	1.30	1.02	1278	-0.7	49	40	26	18
350	4737			-0.09	24	1.78	2236	-2.3	55			50	40	35	32	28		
400	5414			-0.12	28	2.03	2555	-3.0	56			53	43	39	37	32		
500	6768			-0.19	34	2.54	3194	-4.7	58			57	48	46	45	40		
600	8121			-0.27	39	3.05	3833	-6.7	60			60	52	52	51	46		
700	9475			-0.37	43	3.56	4472	-9.2	61			63	56	56	56	51		
800	10828			-0.48	47	4.06	5110	-12.0	62			65	59	60	61	56		
900	12182			-0.61	50	4.57	5749	-15.2	64			67	62	64	65	59		
1000	13535			-0.75	53	5.08	6388	-18.7	65			69	64	67	69	63		
46" x 46"	14.69			200	2844	-0.03	-	1168 x 1168	1.37			1.02	1342	-0.7	50	41	27	18
		350	4977	-0.09	24	1.78	2349			-2.3	55	51	40	35	33	28		
		400	5688	-0.12	28	2.03	2684			-3.0	56	53	43	40	38	33		
		500	7110	-0.19	34	2.54	3355			-4.7	58	57	48	46	45	40		
		600	8532	-0.27	39	3.05	4026			-6.7	60	60	53	52	52	46		
		700	9953	-0.37	44	3.56	4697			-9.2	62	63	56	57	57	52		
		800	11375	-0.48	47	4.06	5369			-12.0	63	65	59	61	62	56		
		900	12797	-0.61	51	4.57	6040			-15.2	64	67	62	64	66	60		
		1000	14219	-0.75	54	5.08	6711			-18.7	65	69	65	68	69	64		
		48" x 46"	15.33	200	2970	-0.03	-			1219 x 1168	1.42	1.02	1401	-0.7	50	41	27	19
350	5197			-0.09	25	1.78	2453	-2.3	55			51	40	36	33	29		
400	5939			-0.12	28	2.03	2803	-3.0	57			53	43	40	38	33		
500	7424			-0.19	34	2.54	3504	-4.7	59			57	49	47	46	41		
600	8909			-0.27	40	3.05	4204	-6.7	60			60	53	52	52	47		
700	10393			-0.37	44	3.56	4905	-9.2	62			63	57	57	57	52		
800	11878			-0.48	48	4.06	5606	-12.0	63			66	60	61	62	57		
900	13363			-0.61	51	4.57	6307	-15.2	64			68	62	65	66	61		
1000	14848			-0.75	54	5.08	7007	-18.7	65			70	65	68	70	64		

NOTES: NC values are based on octave band 2 - 7 sound power levels minus a room absorption of 10dB, re 10⁻¹² Watts. Dash in space denotes a NC or dB value of less than 10. Data was obtained from tests conducted in accordance with ANSI/ASHRAE Standard 70, ISO Standard 5219, and ISO Standard 3741. See Krueger's selection program for performance data not shown, including octave band data.

PERFORMANCE DATA | S80, S580 | 35° DEFLECTION (NO DAMPER)

		IP DATA				NC	METRIC DATA					OCTAVE BAND, dB					
NOM DUCT	DUCT AREA	NECK VEL	AIRFLOW	Ps	NOM DUCT		DUCT AREA	NECK VEL	AIRFLOW	Ps	2	3	4	5	6	7	
in	ft ²	FPM	CFM	"WG	mm	m ²	m/s	L/s	Pa								
48" x 48"	16.00	200	3101	-0.03	-	1219 x 1219	1.49	1.02	1463	-0.7	50	41	27	19	15	-	
		350	5426	-0.09	25			1.78	2561	-2.3	56	51	40	36	34	29	
		400	6202	-0.12	29			2.03	2927	-3.0	57	54	44	40	39	34	
		500	7752	-0.19	35			2.54	3659	-4.7	59	58	49	47	46	41	
		600	9302	-0.27	40			3.05	4390	-6.7	61	61	53	53	53	47	
		700	10853	-0.37	44			3.56	5122	-9.2	62	64	57	57	58	53	
		800	12403	-0.48	48			4.06	5854	-12.0	63	66	60	62	63	57	
		900	13954	-0.61	51			4.57	6585	-15.2	65	68	63	65	67	61	
		1000	15504	-0.75	54			5.08	7317	-18.7	66	70	65	68	70	65	

NOTES: NC values are based on octave band 2 - 7 sound power levels minus a room absorption of 10dB, re 10⁻¹² Watts. Dash in space denotes a NC or dB value of less than 10. Data was obtained from tests conducted in accordance with ANSI/ASHRAE Standard 70, ISO Standard 5219, and ISO Standard 3741. See Krueger's selection program for performance data not shown, including octave band data.

S80 / S580 / S85 / S585 SERIES

Return Grille | Single, Fixed Deflection



GRILLES | RETURN

SOUND CHARTS | S80, S580 | 0° DEFLECTION (NO DAMPER)

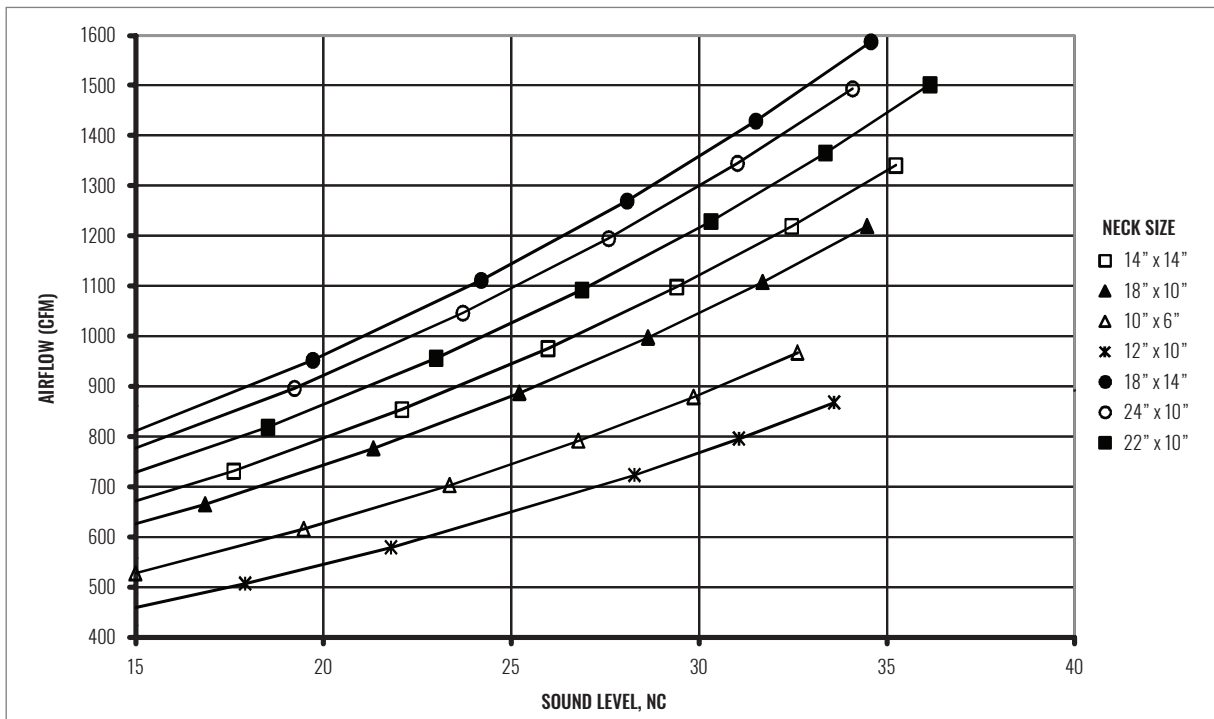
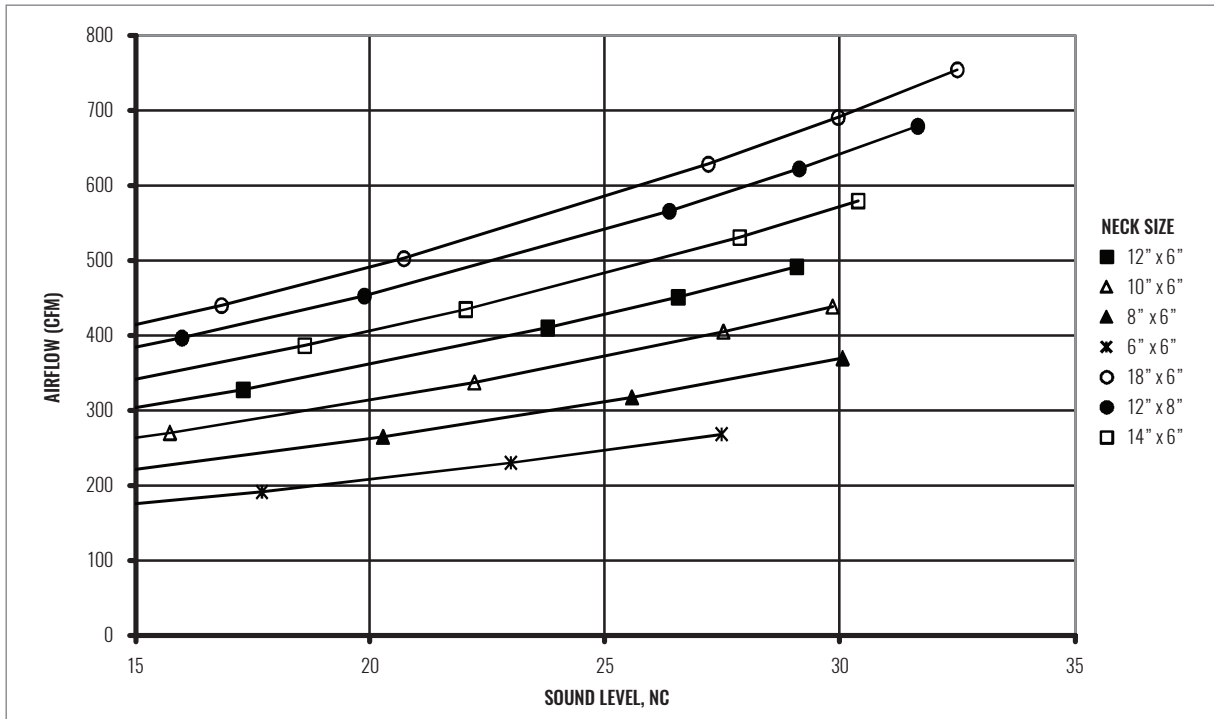

SOUND CHARTS | S80, S580 | 0° DEFLECTION (NO DAMPER)

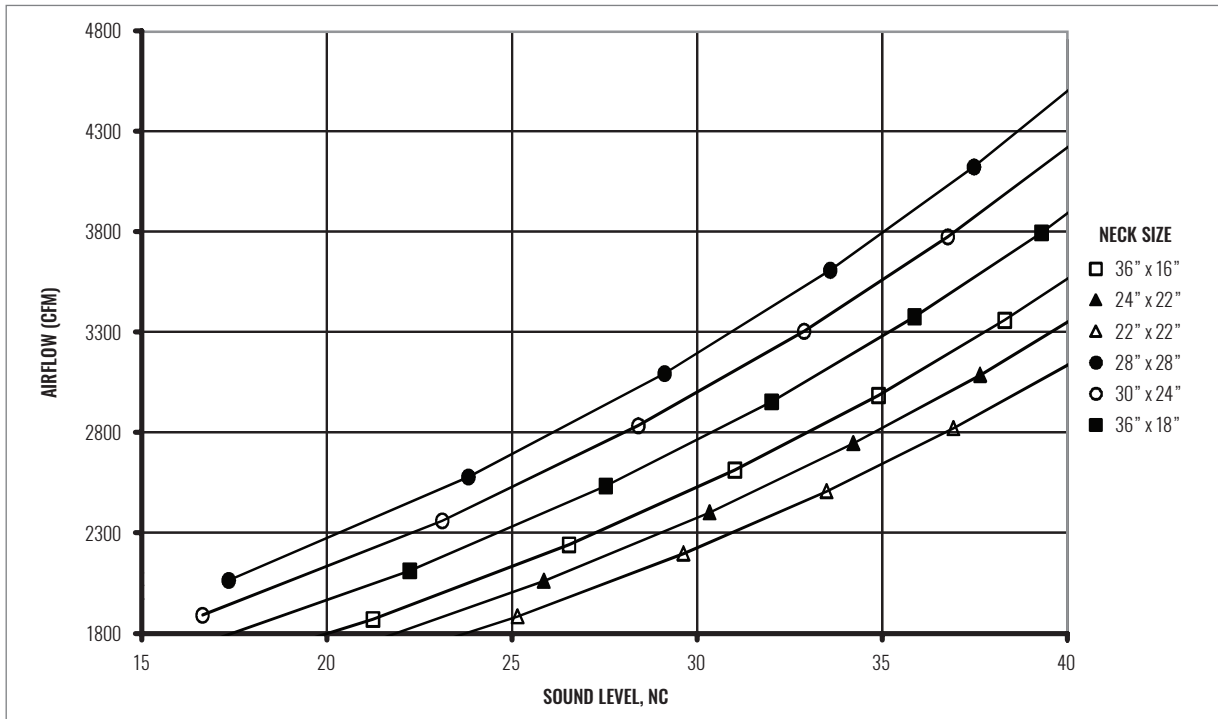
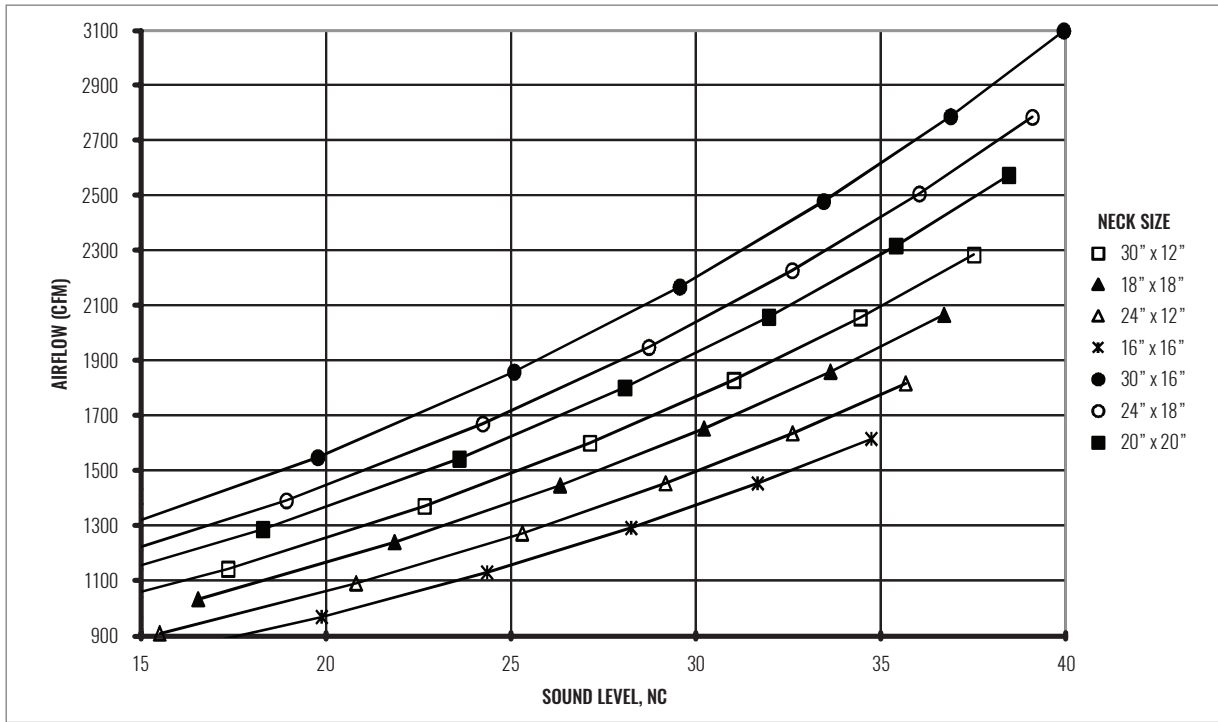

GRILLES | RETURN

S80 / S580 / S85 / S585 SERIES

Return Grille | Single, Fixed Deflection



GRILLES | RETURN

SOUND CHARTS | S80, S580 | 0° DEFLECTION (NO DAMPER)

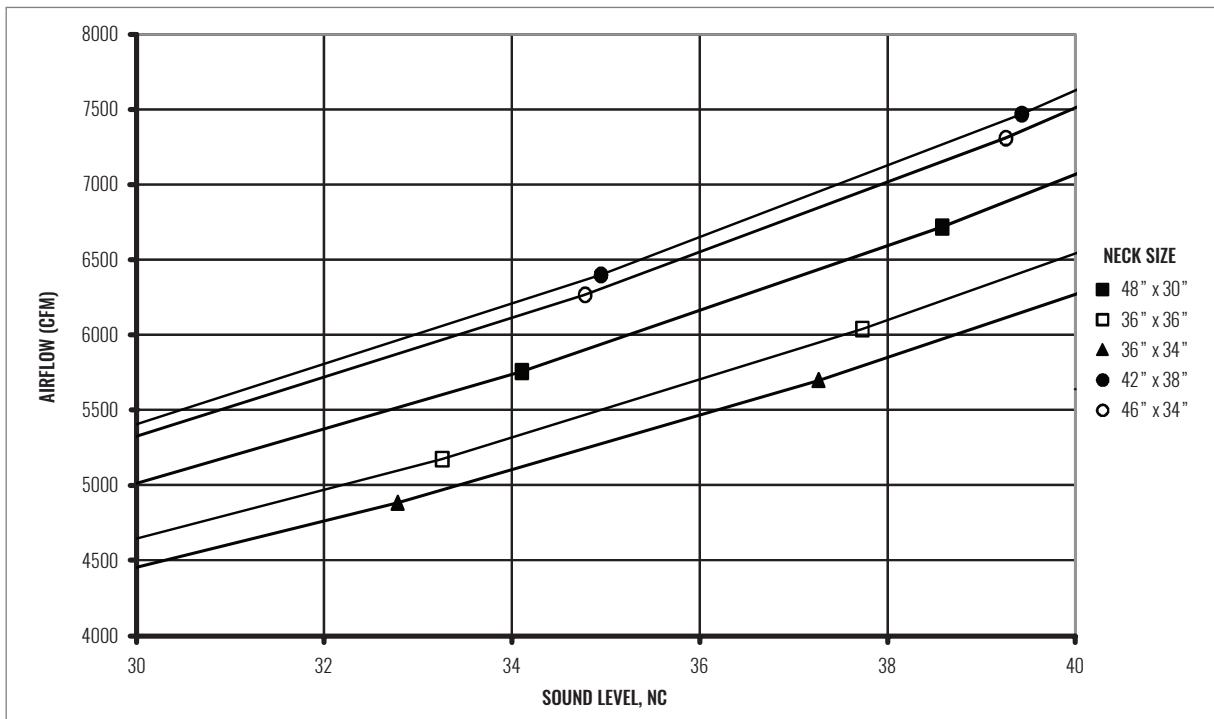
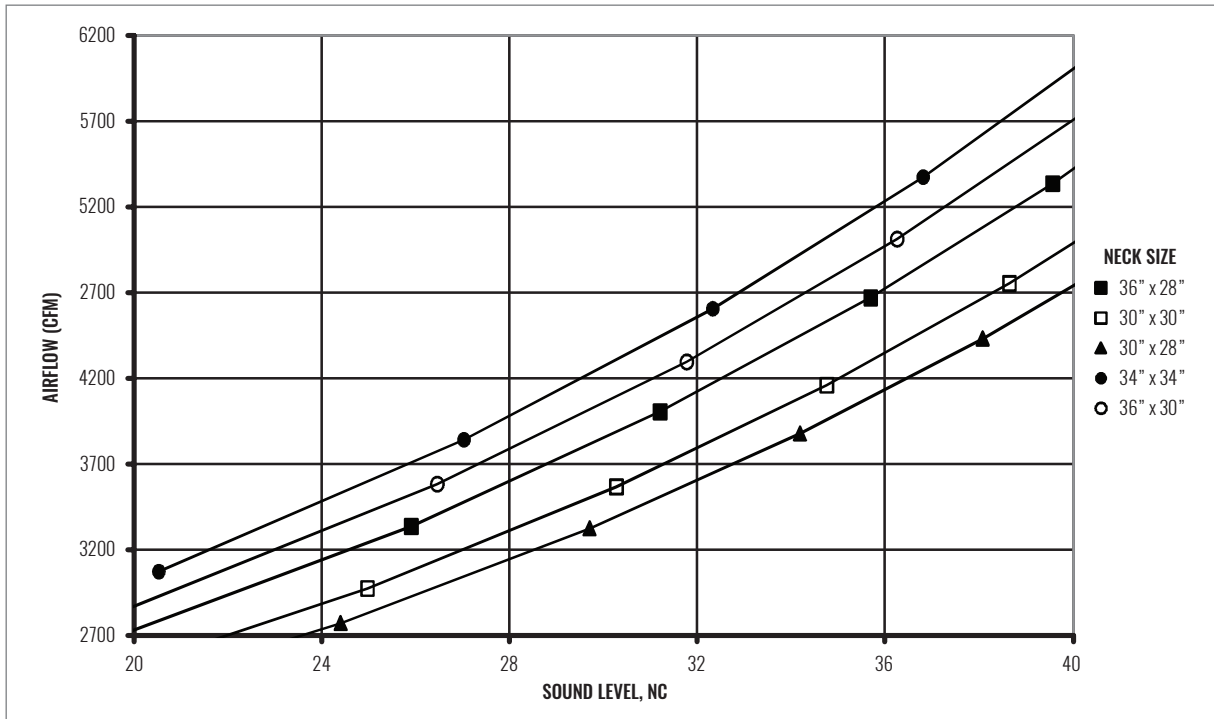

SOUND CHARTS | S80, S580 | 0° DEFLECTION (NO DAMPER)

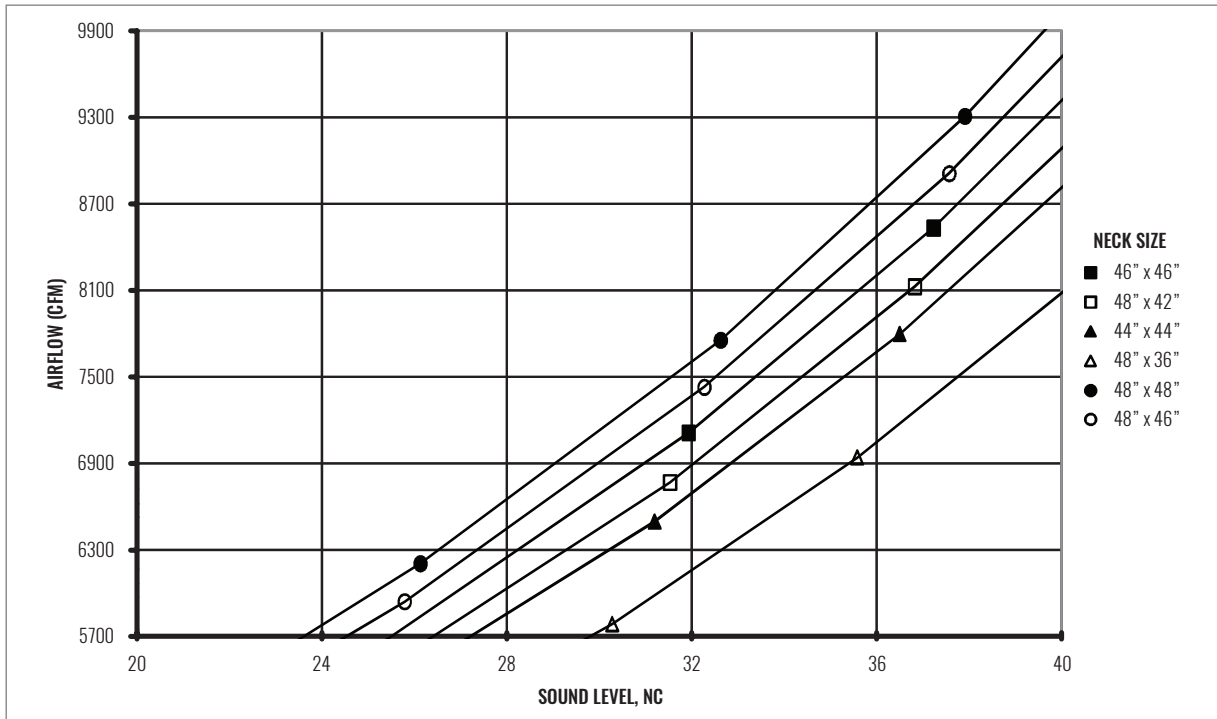

GRILLES | RETURN

S80 / S580 / S85 / S585 SERIES



Return Grille | Single, Fixed Deflection

PERFORMANCE DATA | S80, S580 | 0° DEFLECTION (NO DAMPER)

		IP DATA				NC	METRIC DATA					OCTAVE BAND, dB						
NOM DUCT	DUCT AREA	NECK VEL	AIRFLOW	Ps	NOM DUCT		DUCT AREA	NECK VEL	AIRFLOW	Ps	2	3	4	5	6	7		
in	ft ²	FPM	CFM	"WG	mm		m ²	m/s	L/s	Pa								
6" x 6"	0.25	300	57	-0.003	-	152 x 152	0.02	1.52	27	-0.8	19	-	-	-	-	-		
		400	77	-0.006	-			2.03	36	-1.4	23	-	-	-	-	-		
		500	96	-0.009	-			2.54	45	-2.2	26	13	-	-	-	-		
		600	115	-0.013	-			3.05	54	-3.2	29	17	15	13	-	-		
		700	134	-0.017	-			3.56	63	-4.3	31	21	18	17	-	-		
		800	153	-0.023	11			4.06	72	-5.7	33	24	22	20	12	-		
		1000	191	-0.036	18			5.08	90	-8.9	36	29	27	26	21	-		
		1200	230	-0.051	23			6.10	108	-12.8	38	33	31	31	27	15		
		1400	268	-0.070	27			7.11	126	-17.4	40	37	35	35	33	21		
		8" x 6"	0.33	300	79			-0.003	-	203 x 152	0.03	1.52	37	-0.8	21	-	-	-
400	106			-0.006	-	2.03	50	-1.4	25			11	-	-	-	-		
500	132			-0.009	-	2.54	62	-2.2	28			16	14	11	-	-		
600	159			-0.013	-	3.05	75	-3.2	31			20	18	16	-	-		
700	185			-0.017	-	3.56	87	-4.3	33			24	22	20	11	-		
800	211			-0.023	14	4.06	100	-5.7	35			27	25	23	16	-		
1000	264			-0.036	20	5.08	125	-8.9	38			32	30	29	24	12		
1200	317			-0.051	26	6.10	150	-12.8	40			36	34	34	31	19		
1400	370	-0.070	30	7.11	175	-17.4	42	40	38	38	36	25						
10" x 6"	0.42	300	101	-0.003	-	254 x 152	0.04	1.52	48	-0.8	23	-	-	-	-	-		
		400	135	-0.006	-			2.03	64	-1.4	27	13	11	-	-	-		
		500	169	-0.009	-			2.54	80	-2.2	30	18	16	13	-	-		
		600	202	-0.013	-			3.05	95	-3.2	32	23	20	18	-	-		
		700	236	-0.017	12			3.56	111	-4.3	34	26	24	22	14	-		
		800	270	-0.023	16			4.06	127	-5.7	36	29	27	25	18	-		
		1000	337	-0.036	22			5.08	159	-8.9	39	35	32	31	26	15		
		1200	405	-0.051	28			6.10	191	-12.8	42	39	37	36	33	22		
		1300	438	-0.060	30			6.60	207	-15.0	43	41	39	38	36	26		
		8" x 8"	0.44	300	110			-0.003	-	203 x 203	0.04	1.52	52	-0.8	23	-	-	-
400	146			-0.006	-	2.03	69	-1.4	27			14	11	-	-	-		
500	183			-0.009	-	2.54	86	-2.2	30			19	17	14	-	-		
600	219			-0.013	-	3.05	103	-3.2	33			23	21	19	-	-		
700	256			-0.017	12	3.56	121	-4.3	35			27	25	23	14	-		
800	292			-0.023	16	4.06	138	-5.7	37			30	28	26	19	-		
1000	365			-0.036	23	5.08	172	-8.9	40			35	33	32	27	16		
1200	438			-0.051	28	6.10	207	-12.8	42			40	37	37	34	23		
1300	475	-0.060	30	6.60	224	-15.0	43	42	39	39	37	27						
12" x 6"	0.50	300	123	-0.003	-	305 x 152	0.05	1.52	58	-0.8	24	-	-	-	-	-		
		400	164	-0.006	-			2.03	77	-1.4	28	15	12	-	-	-		
		500	205	-0.009	-			2.54	97	-2.2	31	20	18	15	-	-		
		600	246	-0.013	-			3.05	116	-3.2	33	25	22	20	-	-		
		700	287	-0.017	13			3.56	136	-4.3	36	28	26	24	16	-		
		800	328	-0.023	17			4.06	155	-5.7	37	31	29	27	20	-		
		1000	410	-0.036	24			5.08	194	-8.9	40	37	34	33	29	18		
		1100	451	-0.043	27			5.59	213	-10.7	42	39	36	36	32	22		
		1200	492	-0.051	29			6.10	232	-12.8	43	41	39	38	35	25		
		14" x 6"	0.58	300	145			-0.003	-	356 x 152	0.05	1.52	68	-0.8	25	-	-	-
400	193			-0.006	-	2.03	91	-1.4	29			17	14	-	-	-		
500	242			-0.009	-	2.54	114	-2.2	32			22	19	16	-	-		
600	290			-0.013	-	3.05	137	-3.2	34			26	24	21	12	-		
700	338			-0.017	15	3.56	160	-4.3	37			30	27	25	17	-		
800	386			-0.023	19	4.06	182	-5.7	38			33	30	29	22	11		
900	435			-0.029	22	4.57	205	-7.2	40			36	33	32	26	16		
1100	531			-0.043	28	5.59	251	-10.7	43			40	38	37	34	24		
1200	580	-0.051	30	6.10	274	-12.8	44	42	40	39	37	27						

NOTES: NC values are based on octave band 2 - 7 sound power levels minus a room absorption of 10dB, re 10⁻¹² Watts. Dash in space denotes a NC or dB value of less than 10. Data was obtained from tests conducted in accordance with ANSI/ASHRAE Standard 70, ISO Standard 5219, and ISO Standard 3741. See Krueger's selection program for performance data not shown, including octave band data.

PERFORMANCE DATA | S80, S580 | 0° DEFLECTION (NO DAMPER)

IP DATA					NC	METRIC DATA					OCTAVE BAND, dB						
NOM DUCT	DUCT AREA	NECK VEL	AIRFLOW	Ps		NOM DUCT	DUCT AREA	NECK VEL	AIRFLOW	Ps							
in	ft ²	FPM	CFM	"WG		mm	m ²	m/s	L/s	Pa	2	3	4	5	6	7	
12" x 8"	0.67	300	170	-0.03	-	305 x 203	0.06	1.52	80	-0.8	26	12	-	-	-	-	
		400	227	-0.06	-			2.03	107	-1.4	30	18	16	12	-	-	
		500	283	-0.09	-			2.54	134	-2.2	33	24	21	18	-	-	
		600	340	-0.13	12			3.05	160	-3.2	35	28	25	22	13	-	
		700	396	-0.17	16			3.56	187	-4.3	38	31	29	26	19	-	
		800	453	-0.23	20			4.06	214	-5.7	39	35	32	30	24	13	
		1000	566	-0.36	26			5.08	267	-8.9	43	40	37	36	32	22	
		1100	623	-0.43	29			5.59	294	-10.7	44	42	40	38	35	26	
		1200	680	-0.51	32			6.10	321	-12.8	45	44	42	41	39	29	
10" x 10"	0.69	300	178	-0.03	-	254 x 254	0.06	1.52	84	-0.8	26	12	-	-	-	-	
		400	238	-0.06	-			2.03	112	-1.4	30	19	16	12	-	-	
		500	297	-0.09	-			2.54	140	-2.2	33	24	21	18	-	-	
		600	357	-0.13	12			3.05	168	-3.2	36	28	26	23	14	-	
		700	416	-0.17	16			3.56	196	-4.3	38	32	29	27	19	-	
		800	475	-0.23	20			4.06	224	-5.7	40	35	32	30	24	14	
		1000	594	-0.36	27			5.08	280	-8.9	43	40	38	36	32	23	
		1100	654	-0.43	30			5.59	308	-10.7	44	43	40	39	36	27	
		1200	713	-0.51	32			6.10	337	-12.8	45	45	42	41	39	30	
18" x 6"	0.75	300	189	-0.03	-	457 x 152	0.07	1.52	89	-0.8	26	13	-	-	-	-	
		400	252	-0.06	-			2.03	119	-1.4	30	19	17	13	-	-	
		500	314	-0.09	-			2.54	148	-2.2	34	25	22	19	-	-	
		600	377	-0.13	12			3.05	178	-3.2	36	29	26	23	14	-	
		700	440	-0.17	17			3.56	208	-4.3	38	32	30	27	20	-	
		800	503	-0.23	21			4.06	237	-5.7	40	36	33	31	25	15	
		1000	629	-0.36	27			5.08	297	-8.9	43	41	38	37	33	24	
		1100	692	-0.43	30			5.59	326	-10.7	44	43	41	39	36	27	
		1200	755	-0.51	32			6.10	356	-12.8	46	45	43	42	40	31	
12" x 10"	0.83	300	217	-0.03	-	305 x 254	0.08	1.52	102	-0.8	27	14	11	-	-	-	
		400	289	-0.06	-			2.03	136	-1.4	31	21	18	14	-	-	
		500	361	-0.09	-			2.54	171	-2.2	34	26	23	20	-	-	
		600	434	-0.13	13			3.05	205	-3.2	37	30	28	25	16	-	
		700	506	-0.17	18			3.56	239	-4.3	39	34	31	29	22	11	
		800	578	-0.23	22			4.06	273	-5.7	41	37	34	32	26	16	
		1000	723	-0.36	28			5.08	341	-8.9	44	42	40	38	34	25	
		1100	795	-0.43	31			5.59	375	-10.7	45	44	42	41	38	29	
		1200	867	-0.51	34			6.10	409	-12.8	47	47	44	43	41	33	
22" x 6"	0.92	300	232	-0.03	-	559 x 152	0.09	1.52	110	-0.8	28	15	12	-	-	-	
		400	310	-0.06	-			2.03	146	-1.4	32	21	19	14	-	-	
		500	387	-0.09	-			2.54	183	-2.2	35	27	24	20	-	-	
		600	465	-0.13	14			3.05	219	-3.2	37	31	28	25	17	-	
		700	542	-0.17	18			3.56	256	-4.3	40	35	32	29	22	12	
		800	620	-0.23	22			4.06	293	-5.7	41	38	35	33	27	17	
		1000	775	-0.36	29			5.08	366	-8.9	44	43	40	39	35	26	
		1100	852	-0.43	32			5.59	402	-10.7	46	45	43	41	39	30	
		1200	930	-0.51	34			6.10	439	-12.8	47	47	45	43	42	34	
12" x 12"	1.00	300	264	-0.03	-	305 x 305	0.09	1.52	124	-0.8	29	16	13	-	-	-	
		400	352	-0.06	-			2.03	166	-1.4	33	23	20	16	-	-	
		500	439	-0.09	-			2.54	207	-2.2	36	28	25	21	11	-	
		600	527	-0.13	15			3.05	249	-3.2	38	32	29	26	18	-	
		700	615	-0.17	19			3.56	290	-4.3	40	36	33	30	24	14	
		800	703	-0.23	23			4.06	332	-5.7	42	39	36	34	28	19	
		900	791	-0.29	27			4.57	373	-7.2	44	42	39	37	33	24	
		1000	879	-0.36	30			5.08	415	-8.9	45	44	42	40	37	28	
		1100	967	-0.43	33			5.59	456	-10.7	47	46	44	42	40	32	

NOTES: NC values are based on octave band 2 - 7 sound power levels minus a room absorption of 10dB, re 10⁻¹² Watts. Dash in space denotes a NC or dB value of less than 10. Data was obtained from tests conducted in accordance with ANSI/ASHRAE Standard 70, ISO Standard 5219, and ISO Standard 3741. See Krueger's selection program for performance data not shown, including octave band data.

S80 / S580 / S85 / S585 SERIES



Return Grille | Single, Fixed Deflection

PERFORMANCE DATA | S80, S580 | 0° DEFLECTION (NO DAMPER)

		IP DATA				NC	METRIC DATA					OCTAVE BAND, dB						
NOM DUCT	DUCT AREA	NECK VEL	AIRFLOW	Ps	NOM DUCT		DUCT AREA	NECK VEL	AIRFLOW	Ps								
in	ft ²	FPM	CFM	"WG	mm		m ²	m/s	L/s	Pa	2	3	4	5	6	7		
18" x 10"	1.25	300	332	-0.03	-	457 x 254	0.12	1.52	157	-0.8	30	18	15	-	-	-		
		400	443	-0.06	-			2.03	209	-1.4	34	25	22	18	-	-		
		500	554	-0.09	12			2.54	261	-2.2	37	30	27	23	14	-		
		600	665	-0.13	17			3.05	314	-3.2	40	35	32	28	20	11		
		700	776	-0.17	21			3.56	366	-4.3	42	38	35	32	26	17		
		800	886	-0.23	25			4.06	418	-5.7	44	41	38	36	31	22		
		900	997	-0.29	29			4.57	471	-7.2	45	44	41	39	35	27		
		1000	1108	-0.36	32			5.08	523	-8.9	47	47	44	42	39	31		
		1100	1219	-0.43	34			5.59	575	-10.7	48	49	46	44	42	35		
		14" x 14"	1.36	300	366			-0.03	-	356 x 356	0.13	1.52	173	-0.8	31	19	16	11
400	488			-0.06	-	2.03	230	-1.4	35			26	23	18	-	-		
500	610			-0.09	12	2.54	288	-2.2	38			31	28	24	15	-		
600	732			-0.13	18	3.05	345	-3.2	40			36	33	29	21	12		
700	853			-0.17	22	3.56	403	-4.3	42			39	36	33	27	18		
800	975			-0.23	26	4.06	460	-5.7	44			42	39	37	32	24		
900	1097			-0.29	29	4.57	518	-7.2	46			45	42	40	36	28		
1000	1219			-0.36	32	5.08	575	-8.9	47			48	45	43	40	32		
1100	1341	-0.43	35	5.59	633	-10.7	49	50	47	45	43	36						
27" x 8"	1.50	300	396	-0.03	-	686 x 203	0.14	1.52	187	-0.8	31	20	17	12	-	-		
		400	529	-0.06	-			2.03	249	-1.4	35	27	24	19	-	-		
		500	661	-0.09	13			2.54	312	-2.2	38	32	29	25	16	-		
		600	793	-0.13	18			3.05	374	-3.2	41	36	33	30	22	13		
		700	925	-0.17	23			3.56	437	-4.3	43	40	37	34	28	19		
		800	1057	-0.23	27			4.06	499	-5.7	45	43	40	37	33	25		
		900	1189	-0.29	30			4.57	561	-7.2	46	46	43	41	37	29		
		1000	1322	-0.36	33			5.08	624	-8.9	48	48	45	43	41	34		
		1100	1454	-0.43	36			5.59	686	-10.7	49	51	48	46	44	37		
		22" x 10"	1.53	300	410			-0.03	-	559 x 254	0.14	1.52	193	-0.8	31	20	17	12
400	546			-0.06	-	2.03	258	-1.4	35			27	24	19	-	-		
500	683			-0.09	13	2.54	322	-2.2	38			32	29	25	16	-		
600	819			-0.13	19	3.05	387	-3.2	41			37	34	30	23	14		
700	956			-0.17	23	3.56	451	-4.3	43			40	37	34	28	20		
800	1092			-0.23	27	4.06	515	-5.7	45			43	40	38	33	25		
900	1229			-0.29	30	4.57	580	-7.2	47			46	43	41	37	30		
1000	1365			-0.36	33	5.08	644	-8.9	48			49	46	44	41	34		
1100	1502	-0.43	36	5.59	709	-10.7	49	51	48	46	45	38						
24" x 10"	1.67	200	299	-0.01	-	610 x 254	0.15	1.02	141	-0.4	26	12	-	-	-	-		
		300	448	-0.03	-			1.52	211	-0.8	32	21	18	13	-	-		
		400	597	-0.06	-			2.03	282	-1.4	36	28	25	20	-	-		
		500	747	-0.09	14			2.54	352	-2.2	39	33	30	26	17	-		
		600	896	-0.13	19			3.05	423	-3.2	41	38	34	31	24	15		
		700	1045	-0.17	24			3.56	493	-4.3	44	41	38	35	29	21		
		800	1195	-0.23	28			4.06	564	-5.7	45	44	41	38	34	26		
		900	1344	-0.29	31			4.57	634	-7.2	47	47	44	42	38	31		
		1000	1493	-0.36	34			5.08	705	-8.9	49	50	47	44	42	35		
		18" x 14"	1.75	200	317			-0.01	-	457 x 356	0.16	1.02	150	-0.4	27	12	-	-
300	476			-0.03	-	1.52	225	-0.8	32			22	19	13	-	-		
400	635			-0.06	-	2.03	300	-1.4	36			29	25	21	-	-		
500	794			-0.09	14	2.54	375	-2.2	39			34	31	27	18	-		
600	952			-0.13	20	3.05	449	-3.2	42			38	35	31	24	16		
700	1111			-0.17	24	3.56	524	-4.3	44			42	39	35	30	22		
800	1270			-0.23	28	4.06	599	-5.7	46			45	42	39	35	27		
900	1429			-0.29	32	4.57	674	-7.2	47			48	45	42	39	32		
1000	1587	-0.36	35	5.08	749	-8.9	49	50	47	45	43	36						

NOTES: NC values are based on octave band 2 - 7 sound power levels minus a room absorption of 10dB, re 10⁻¹² Watts. Dash in space denotes a NC or dB value of less than 10. Data was obtained from tests conducted in accordance with ANSI/ASHRAE Standard 70, ISO Standard 5219, and ISO Standard 3741. See Krueger's selection program for performance data not shown, including octave band data.

PERFORMANCE DATA | S80, S580 | 0° DEFLECTION (NO DAMPER)

IP DATA					NC	METRIC DATA					OCTAVE BAND, dB						
NOM DUCT	DUCT AREA	NECK VEL	AIRFLOW	Ps		NOM DUCT	DUCT AREA	NECK VEL	AIRFLOW	Ps	OCTAVE BAND, dB						
in	ft ²	FPM	CFM	"WG		mm	m ²	m/s	L/s	Pa	2	3	4	5	6	7	
16" x 16"	1.78	200	323	-0.01	-	406 x 406	0.17	1.02	152	-0.4	27	13	-	-	-	-	
		300	485	-0.03	-			1.52	229	-0.8	32	22	19	13	-	-	
		400	646	-0.06	-			2.03	305	-1.4	36	29	26	21	-	-	
		500	808	-0.09	15			2.54	381	-2.2	39	34	31	27	18	-	
		600	969	-0.13	20			3.05	457	-3.2	42	38	35	32	24	16	
		700	1131	-0.17	24			3.56	534	-4.3	44	42	39	36	30	22	
		800	1292	-0.23	28			4.06	610	-5.7	46	45	42	39	35	27	
		900	1454	-0.29	32			4.57	686	-7.2	48	48	45	42	39	32	
		1000	1615	-0.36	35			5.08	762	-8.9	49	50	47	45	43	36	
		24" x 12"	2.00	200	363			-0.01	-	610 x 305	0.19	1.02	171	-0.4	27	14	-
300	545			-0.03	-	1.52	257	-0.8	33			23	20	14	-	-	
400	727			-0.06	-	2.03	343	-1.4	37			30	27	22	11	-	
500	908			-0.09	16	2.54	429	-2.2	40			35	32	28	19	-	
600	1090			-0.13	21	3.05	514	-3.2	43			40	36	33	26	17	
700	1271			-0.17	25	3.56	600	-4.3	45			43	40	37	31	24	
800	1453			-0.23	29	4.06	686	-5.7	47			46	43	40	36	29	
900	1635			-0.29	33	4.57	772	-7.2	48			49	46	43	40	34	
1000	1816			-0.36	36	5.08	857	-8.9	50			52	48	46	44	38	
18" x 18"	2.25			200	413	-0.01	-	457 x 457	0.21			1.02	195	-0.4	28	15	11
		300	620	-0.03	-	1.52	293			-0.8	34	25	21	15	-	-	
		400	827	-0.06	-	2.03	390			-1.4	38	31	28	23	12	-	
		500	1033	-0.09	17	2.54	488			-2.2	41	37	33	29	20	12	
		600	1240	-0.13	22	3.05	585			-3.2	43	41	38	34	27	19	
		700	1446	-0.17	26	3.56	683			-4.3	46	44	41	38	33	25	
		800	1653	-0.23	30	4.06	780			-5.7	47	48	44	41	37	31	
		900	1860	-0.29	34	4.57	878			-7.2	49	50	47	44	42	35	
		1000	2066	-0.36	37	5.08	975			-8.9	51	53	50	47	46	40	
		24" x 14"	2.33	200	428	-0.01	-			610 x 356	0.22	1.02	202	-0.4	28	15	12
300	642			-0.03	-	1.52	303	-0.8	34			25	21	16	-	-	
400	856			-0.06	-	2.03	404	-1.4	38			32	28	23	13	-	
500	1070			-0.09	17	2.54	505	-2.2	41			37	34	29	21	12	
600	1284			-0.13	22	3.05	606	-3.2	44			41	38	34	27	20	
700	1498			-0.17	27	3.56	707	-4.3	46			45	42	38	33	26	
800	1711			-0.23	30	4.06	808	-5.7	48			48	45	42	38	31	
900	1925			-0.29	34	4.57	909	-7.2	49			51	48	45	42	36	
1000	2139			-0.36	37	5.08	1010	-8.9	51			53	50	47	46	40	
30" x 12"	2.50			200	457	-0.01	-	762 x 305	0.23			1.02	216	-0.4	29	16	12
		300	686	-0.03	-	1.52	324			-0.8	34	26	22	16	-	-	
		400	914	-0.06	11	2.03	431			-1.4	38	32	29	24	13	-	
		500	1143	-0.09	17	2.54	539			-2.2	42	38	34	30	21	13	
		600	1371	-0.13	23	3.05	647			-3.2	44	42	39	35	28	21	
		700	1600	-0.17	27	3.56	755			-4.3	46	45	42	39	34	27	
		800	1828	-0.23	31	4.06	863			-5.7	48	49	45	42	38	32	
		900	2057	-0.29	34	4.57	971			-7.2	50	51	48	45	43	37	
		1000	2285	-0.36	37	5.08	1078			-8.9	51	54	51	48	47	41	
		24" x 16"	2.67	200	492	-0.01	-			610 x 406	0.25	1.02	232	-0.4	29	17	13
300	739			-0.03	-	1.52	349	-0.8	35			26	23	17	-	-	
400	985			-0.06	11	2.03	465	-1.4	39			33	30	25	14	-	
500	1231			-0.09	18	2.54	581	-2.2	42			38	35	30	22	14	
600	1477			-0.13	23	3.05	697	-3.2	45			43	39	35	29	22	
700	1724			-0.17	28	3.56	813	-4.3	47			46	43	39	34	28	
800	1970			-0.23	32	4.06	930	-5.7	49			49	46	43	39	33	
900	2216			-0.29	35	4.57	1046	-7.2	50			52	49	46	44	38	
1000	2462			-0.36	38	5.08	1162	-8.9	52			55	51	49	47	42	

NOTES: NC values are based on octave band 2 - 7 sound power levels minus a room absorption of 10dB, re 10⁻¹² Watts. Dash in space denotes a NC or dB value of less than 10. Data was obtained from tests conducted in accordance with ANSI/ASHRAE Standard 70, ISO Standard 5219, and ISO Standard 3741. See Krueger's selection program for performance data not shown, including octave band data.

S80 / S580 / S85 / S585 SERIES



Return Grille | Single, Fixed Deflection

PERFORMANCE DATA | S80, S580 | 0° DEFLECTION (NO DAMPER)

		IP DATA				NC	METRIC DATA					OCTAVE BAND, dB						
NOM DUCT	DUCT AREA	NECK VEL	AIRFLOW	Ps	NOM DUCT		DUCT AREA	NECK VEL	AIRFLOW	Ps								
in	ft ²	FPM	CFM	"WG	mm		m ²	m/s	L/s	Pa	2	3	4	5	6	7		
20" x 20"	2.78	200	515	-0.01	-	508 x 508	0.26	1.02	243	-0.4	30	17	14	-	-	-		
		300	772	-0.03	-			1.52	364	-0.8	35	27	23	17	-	-		
		400	1029	-0.06	12			2.03	486	-1.4	39	34	30	25	15	-		
		500	1287	-0.09	18			2.54	607	-2.2	42	39	35	31	23	15		
		600	1544	-0.13	24			3.05	729	-3.2	45	43	40	36	29	22		
		700	1801	-0.17	28			3.56	850	-4.3	47	47	43	40	35	28		
		800	2059	-0.23	32			4.06	972	-5.7	49	50	46	43	40	34		
		900	2316	-0.29	35			4.57	1093	-7.2	50	53	49	46	44	38		
		1000	2573	-0.36	38			5.08	1214	-8.9	52	55	52	49	48	43		
		24" x 18"	3.00	200	557			-0.01	-	610 x 457	0.28	1.02	263	-0.4	26	12	-	-
300	836			-0.03	-	1.52	394	-0.8	32			21	18	13	-	-		
400	1114			-0.06	12	2.03	526	-1.4	36			28	25	20	-	-		
500	1393			-0.09	19	2.54	657	-2.2	39			33	30	26	17	-		
600	1671			-0.13	24	3.05	789	-3.2	41			38	34	31	24	15		
700	1950			-0.17	29	3.56	920	-4.3	44			41	38	35	29	21		
800	2228			-0.23	33	4.06	1052	-5.7	45			44	41	38	34	26		
900	2507			-0.29	36	4.57	1183	-7.2	47			47	44	42	38	31		
1000	2785			-0.36	39	5.08	1314	-8.9	49			50	47	44	42	35		
30" x 16"	3.33			200	620	-0.01	-	762 x 406	0.31			1.02	292	-0.4	27	12	-	-
		300	929	-0.03	-	1.52	439			-0.8	32	22	19	13	-	-		
		400	1239	-0.06	13	2.03	585			-1.4	36	29	25	21	-	-		
		500	1549	-0.09	20	2.54	731			-2.2	39	34	31	27	18	-		
		600	1859	-0.13	25	3.05	877			-3.2	42	38	35	31	24	16		
		700	2168	-0.17	30	3.56	1023			-4.3	44	42	39	35	30	22		
		800	2478	-0.23	33	4.06	1170			-5.7	46	45	42	39	35	27		
		900	2788	-0.29	37	4.57	1316			-7.2	47	48	45	42	39	32		
		1000	3098	-0.36	40	5.08	1462			-8.9	49	50	47	45	43	36		
		22" x 22"	3.36	200	627	-0.01	-			559 x 559	0.31	1.02	296	-0.4	31	19	15	-
400	1254			-0.06	13	2.03	592	-1.4	40			36	32	27	17	-		
500	1568			-0.09	20	2.54	740	-2.2	44			41	37	33	25	17		
600	1882			-0.13	25	3.05	888	-3.2	46			45	42	37	31	25		
700	2195			-0.17	30	3.56	1036	-4.3	48			49	45	41	37	31		
800	2509			-0.23	34	4.06	1184	-5.7	50			52	48	45	42	36		
900	2822			-0.29	37	4.57	1332	-7.2	52			55	51	48	46	41		
1000	3136			-0.36	40	5.08	1480	-8.9	53			57	54	51	50	45		
1100	3449			-0.43	43	5.59	1628	-10.7	55			59	56	53	53	49		
36" x 14"	3.50			200	649	-0.01	-	914 x 356	0.33			1.02	306	-0.4	31	20	16	-
		400	1297	-0.06	14	2.03	612			-1.4	41	36	32	27	17	-		
		500	1622	-0.09	20	2.54	765			-2.2	44	41	38	33	25	18		
		600	1946	-0.13	25	3.05	918			-3.2	46	45	42	38	32	25		
		700	2270	-0.17	30	3.56	1072			-4.3	48	49	46	42	37	31		
		800	2595	-0.23	34	4.06	1225			-5.7	50	52	49	45	42	37		
		900	2919	-0.29	37	4.57	1378			-7.2	52	55	51	48	46	42		
		1000	3243	-0.36	40	5.08	1531			-8.9	53	57	54	51	50	46		
		1100	3568	-0.43	43	5.59	1684			-10.7	55	60	56	54	54	50		
		24" x 22"	3.67	200	686	-0.01	-			610 x 559	0.34	1.02	324	-0.4	31	20	16	-
400	1372			-0.06	14	2.03	648	-1.4	41			36	33	27	18	-		
500	1715			-0.09	21	2.54	810	-2.2	44			42	38	33	26	19		
600	2059			-0.13	26	3.05	972	-3.2	47			46	42	38	32	26		
700	2402			-0.17	30	3.56	1133	-4.3	49			50	46	42	38	32		
800	2745			-0.23	34	4.06	1295	-5.7	51			53	49	46	43	38		
900	3088			-0.29	38	4.57	1457	-7.2	52			55	52	49	47	42		
1000	3431			-0.36	41	5.08	1619	-8.9	54			58	55	52	51	47		
1100	3774			-0.43	44	5.59	1781	-10.7	55			60	57	54	54	50		

NOTES: NC values are based on octave band 2 - 7 sound power levels minus a room absorption of 10dB, re 10⁻¹² Watts. Dash in space denotes a NC or dB value of less than 10. Data was obtained from tests conducted in accordance with ANSI/ASHRAE Standard 70, ISO Standard 5219, and ISO Standard 3741. See Krueger's selection program for performance data not shown, including octave band data.

PERFORMANCE DATA | S80, S580 | 0° DEFLECTION (NO DAMPER)

IP DATA					NC	METRIC DATA					OCTAVE BAND, dB						
NOM DUCT	DUCT AREA	NECK VEL	AIRFLOW	Ps		NOM DUCT	DUCT AREA	NECK VEL	AIRFLOW	Ps	OCTAVE BAND, dB						
in	ft ²	FPM	CFM	"WG		mm	m ²	m/s	L/s	Pa	2	3	4	5	6	7	
30" x 18"	3.75	200	701	-0.01	-	762 x 457	0.35	1.02	331	-0.4	32	20	16	-	-	-	
		400	1402	-0.06	14			2.03	661	-1.4	41	37	33	28	18	-	
		500	1752	-0.09	21			2.54	827	-2.2	44	42	38	34	26	19	
		600	2102	-0.13	26			3.05	992	-3.2	47	46	43	38	33	26	
		700	2453	-0.17	31			3.56	1158	-4.3	49	50	46	42	38	33	
		800	2803	-0.23	34			4.06	1323	-5.7	51	53	49	46	43	38	
		900	3154	-0.29	38			4.57	1488	-7.2	52	56	52	49	47	43	
		1000	3504	-0.36	41			5.08	1654	-8.9	54	58	55	52	51	47	
		1100	3854	-0.43	44			5.59	1819	-10.7	55	60	57	54	55	51	
		36" x 16"	4.00	200	747			-0.01	-	914 x 406	0.37	1.02	352	-0.4	32	21	17
400	1493			-0.06	15	2.03	705	-1.4	42			37	34	28	18	11	
500	1867			-0.09	21	2.54	881	-2.2	45			43	39	34	27	20	
600	2240			-0.13	27	3.05	1057	-3.2	47			47	43	39	33	27	
700	2613			-0.17	31	3.56	1233	-4.3	49			50	47	43	39	33	
800	2986			-0.23	35	4.06	1409	-5.7	51			54	50	46	44	39	
900	3360			-0.29	38	4.57	1586	-7.2	53			56	53	50	48	43	
1000	3733			-0.36	41	5.08	1762	-8.9	54			59	55	52	52	48	
1100	4106			-0.43	44	5.59	1938	-10.7	56			61	58	55	55	51	
36" x 18"	4.50			200	845	-0.01	-	914 x 457	0.42			1.02	399	-0.4	33	22	18
		400	1689	-0.06	16	2.03	797			-1.4	42	39	35	29	20	13	
		500	2111	-0.09	22	2.54	996			-2.2	45	44	40	35	28	22	
		600	2534	-0.13	28	3.05	1196			-3.2	48	48	44	40	34	29	
		700	2956	-0.17	32	3.56	1395			-4.3	50	52	48	44	40	35	
		800	3378	-0.23	36	4.06	1594			-5.7	52	55	51	48	45	40	
		900	3800	-0.29	39	4.57	1794			-7.2	54	58	54	51	49	45	
		1000	4223	-0.36	42	5.08	1993			-8.9	55	60	57	53	53	49	
		1100	4645	-0.43	45	5.59	2192			-10.7	56	62	59	56	56	53	
		30" x 24"	5.00	200	945	-0.01	-			762 x 610	0.46	1.02	446	-0.4	33	23	19
400	1889			-0.06	17	2.03	892	-1.4	43			40	36	30	21	14	
500	2361			-0.09	23	2.54	1114	-2.2	46			45	41	36	29	23	
600	2834			-0.13	28	3.05	1337	-3.2	49			49	45	41	36	30	
700	3306			-0.17	33	3.56	1560	-4.3	51			53	49	45	41	37	
800	3778			-0.23	37	4.06	1783	-5.7	53			56	52	49	46	42	
900	4250			-0.29	40	4.57	2006	-7.2	54			59	55	52	50	47	
1000	4723			-0.36	43	5.08	2229	-8.9	56			61	58	54	54	51	
1100	5195			-0.43	46	5.59	2452	-10.7	57			63	60	57	58	55	
42" x 18"	5.25			200	988	-0.01	-	1067 x 457	0.49			1.02	466	-0.4	26	12	-
		400	1977	-0.06	17	2.03	933			-1.4	36	28	25	20	-	-	
		500	2471	-0.09	23	2.54	1166			-2.2	39	33	30	26	17	-	
		600	2965	-0.13	29	3.05	1399			-3.2	41	38	34	31	24	15	
		700	3459	-0.17	33	3.56	1632			-4.3	44	41	38	35	29	21	
		800	3953	-0.23	37	4.06	1866			-5.7	45	44	41	38	34	26	
		900	4447	-0.29	41	4.57	2099			-7.2	47	47	44	42	38	31	
		1000	4941	-0.36	44	5.08	2332			-8.9	49	50	47	44	42	35	
		1100	5436	-0.43	46	5.59	2565			-10.7	50	52	49	47	46	39	
		28" x 28"	5.44	200	1031	-0.01	-			711 x 711	0.51	1.02	487	-0.4	27	12	-
400	2063			-0.06	17	2.03	973	-1.4	36			29	25	21	-	-	
500	2578			-0.09	24	2.54	1217	-2.2	39			34	31	27	18	-	
600	3094			-0.13	29	3.05	1460	-3.2	42			38	35	31	24	16	
700	3610			-0.17	34	3.56	1704	-4.3	44			42	39	35	30	22	
800	4125			-0.23	38	4.06	1947	-5.7	46			45	42	39	35	27	
900	4641			-0.29	41	4.57	2190	-7.2	47			48	45	42	39	32	
1000	5157			-0.36	44	5.08	2434	-8.9	49			50	47	45	43	36	
1100	5672			-0.43	47	5.59	2677	-10.7	50			52	49	47	46	40	

NOTES: NC values are based on octave band 2 - 7 sound power levels minus a room absorption of 10dB, re 10⁻¹² Watts. Dash in space denotes a NC or dB value of less than 10. Data was obtained from tests conducted in accordance with ANSI/ASHRAE Standard 70, ISO Standard 5219, and ISO Standard 3741. See Krueger's selection program for performance data not shown, including octave band data.

S80 / S580 / S85 / S585 SERIES



Return Grille | Single, Fixed Deflection

PERFORMANCE DATA | S80, S580 | 0° DEFLECTION (NO DAMPER)

		IP DATA				NC	METRIC DATA					OCTAVE BAND, dB						
NOM DUCT	DUCT AREA	NECK VEL	AIRFLOW	Ps	NOM DUCT		DUCT AREA	NECK VEL	AIRFLOW	Ps	2	3	4	5	6	7		
in	ft ²	FPM	CFM	"WG	mm		m ²	m/s	L/s	Pa								
30" x 28"	5.83	200	1107	-0.01	-	762 x 711	0.54	1.02	522	-0.4	34	25	21	13	-	-		
		400	2214	-0.06	18			2.03	1045	-1.4	44	41	37	32	23	16		
		500	2768	-0.09	24			2.54	1306	-2.2	47	47	43	38	31	25		
		600	3321	-0.13	30			3.05	1567	-3.2	50	51	47	42	37	33		
		700	3875	-0.17	34			3.56	1829	-4.3	52	54	51	46	43	39		
		800	4428	-0.23	38			4.06	2090	-5.7	54	58	54	50	48	44		
		900	4982	-0.29	41			4.57	2351	-7.2	55	60	57	53	52	49		
		1000	5535	-0.36	45			5.08	2612	-8.9	57	63	59	56	56	53		
		1100	6089	-0.43	47			5.59	2874	-10.7	58	65	61	58	59	57		
		36" x 24"	6.00	200	1138			-0.01	-	914 x 610	0.56	1.02	537	-0.4	35	25	21	14
400	2277			-0.06	18	2.03	1074	-1.4	44			42	38	32	23	17		
500	2846			-0.09	25	2.54	1343	-2.2	47			47	43	38	31	26		
600	3415			-0.13	30	3.05	1612	-3.2	50			51	47	43	38	33		
700	3984			-0.17	34	3.56	1880	-4.3	52			55	51	47	43	39		
800	4553			-0.23	38	4.06	2149	-5.7	54			58	54	50	48	44		
900	5122			-0.29	42	4.57	2417	-7.2	55			61	57	53	52	49		
1000	5691			-0.36	45	5.08	2686	-8.9	57			63	59	56	56	53		
1100	6261			-0.43	48	5.59	2955	-10.7	58			65	62	59	60	57		
30" x 30"	6.25			200	1188	-0.01	-	762 x 762	0.58			1.02	561	-0.4	35	26	22	14
		400	2377	-0.06	18	2.03	1122			-1.4	44	42	38	32	23	17		
		500	2971	-0.09	25	2.54	1402			-2.2	48	47	43	38	31	26		
		600	3565	-0.13	30	3.05	1682			-3.2	50	52	48	43	38	33		
		700	4159	-0.17	35	3.56	1963			-4.3	52	55	51	47	44	40		
		800	4753	-0.23	39	4.06	2243			-5.7	54	58	54	51	48	45		
		900	5347	-0.29	42	4.57	2524			-7.2	56	61	57	54	53	50		
		1000	5941	-0.36	45	5.08	2804			-8.9	57	63	60	56	57	54		
		1100	6536	-0.43	48	5.59	3084			-10.7	58	66	62	59	60	58		
		36" x 28"	7.00	200	1334	-0.01	-			914 x 711	0.65	1.02	630	-0.4	36	27	23	15
400	2668			-0.06	19	2.03	1259	-1.4	45			43	39	33	25	19		
500	3335			-0.09	26	2.54	1574	-2.2	48			48	44	39	33	28		
600	4002			-0.13	31	3.05	1889	-3.2	51			53	49	44	39	35		
700	4669			-0.17	36	3.56	2204	-4.3	53			56	52	48	45	41		
800	5336			-0.23	40	4.06	2519	-5.7	55			59	56	52	50	47		
900	6004			-0.29	43	4.57	2833	-7.2	56			62	58	55	54	51		
1000	6671			-0.36	46	5.08	3148	-8.9	58			65	61	57	58	56		
1100	7338			-0.43	49	5.59	3463	-10.7	59			67	63	60	61	59		
46" x 22"	7.03			200	1336	-0.01	-	1168 x 559	0.65			1.02	630	-0.4	36	27	23	15
		400	2671	-0.06	19	2.03	1261			-1.4	45	43	39	33	25	19		
		500	3339	-0.09	26	2.54	1576			-2.2	48	48	44	39	33	28		
		600	4007	-0.13	31	3.05	1891			-3.2	51	53	49	44	39	35		
		700	4674	-0.17	36	3.56	2206			-4.3	53	56	52	48	45	41		
		800	5342	-0.23	40	4.06	2521			-5.7	55	59	56	52	50	47		
		900	6010	-0.29	43	4.57	2836			-7.2	56	62	58	55	54	51		
		1000	6678	-0.36	46	5.08	3151			-8.9	58	65	61	57	58	56		
		1100	7345	-0.43	49	5.59	3467			-10.7	59	67	63	60	61	59		
		32" x 32"	7.11	200	1356	-0.01	-			813 x 813	0.66	1.02	640	-0.4	36	27	23	15
400	2713			-0.06	20	2.03	1280	-1.4	45			43	39	33	25	19		
500	3391			-0.09	26	2.54	1600	-2.2	48			49	45	39	33	28		
600	4069			-0.13	31	3.05	1920	-3.2	51			53	49	44	39	35		
700	4747			-0.17	36	3.56	2240	-4.3	53			56	53	48	45	41		
800	5425			-0.23	40	4.06	2560	-5.7	55			60	56	52	50	47		
900	6104			-0.29	43	4.57	2881	-7.2	57			62	59	55	54	52		
1000	6782			-0.36	46	5.08	3201	-8.9	58			65	61	58	58	56		
1100	7460			-0.43	49	5.59	3521	-10.7	59			67	63	60	61	60		

NOTES: NC values are based on octave band 2 - 7 sound power levels minus a room absorption of 10dB, re 10⁻¹² Watts. Dash in space denotes a NC or dB value of less than 10. Data was obtained from tests conducted in accordance with ANSI/ASHRAE Standard 70, ISO Standard 5219, and ISO Standard 3741. See Krueger's selection program for performance data not shown, including octave band data.

PERFORMANCE DATA | S80, S580 | 0° DEFLECTION (NO DAMPER)

IP DATA					NC	METRIC DATA					OCTAVE BAND, dB						
NOM DUCT	DUCT AREA	NECK VEL	AIRFLOW	Ps		NOM DUCT	DUCT AREA	NECK VEL	AIRFLOW	Ps	OCTAVE BAND, dB						
in	ft ²	FPM	CFM	"WG		mm	m ²	m/s	L/s	Pa	2	3	4	5	6	7	
36" x 30"	7.50	200	1432	-0.01	-	914 x 762	0.70	1.02	676	-0.4	36	28	23	16	-	-	
		400	2864	-0.06	20			2.03	1352	-1.4	46	44	40	34	25	20	
		500	3580	-0.09	26			2.54	1690	-2.2	49	49	45	40	33	29	
		600	4296	-0.13	32			3.05	2028	-3.2	51	53	49	45	40	36	
		700	5012	-0.17	36			3.56	2365	-4.3	53	57	53	49	46	42	
		800	5728	-0.23	40			4.06	2703	-5.7	55	60	56	52	50	48	
		900	6444	-0.29	44			4.57	3041	-7.2	57	63	59	55	55	52	
		1000	7160	-0.36	47			5.08	3379	-8.9	58	65	62	58	59	57	
		1100	7876	-0.43	49			5.59	3717	-10.7	60	68	64	61	62	60	
		36" x 32"	8.00	200	1530			-0.01	-	914 x 813	0.74	1.02	722	-0.4	26	12	-
400	3060			-0.06	20	2.03	1444	-1.4	36			28	25	20	-	-	
500	3825			-0.09	27	2.54	1805	-2.2	39			33	30	26	17	-	
600	4590			-0.13	32	3.05	2166	-3.2	41			38	34	31	24	15	
700	5355			-0.17	37	3.56	2527	-4.3	44			41	38	35	29	21	
800	6120			-0.23	41	4.06	2888	-5.7	45			44	41	38	34	26	
900	6885			-0.29	44	4.57	3249	-7.2	47			47	44	42	38	31	
1000	7650			-0.36	47	5.08	3610	-8.9	49			50	47	44	42	35	
1100	8415			-0.43	50	5.59	3971	-10.7	50			52	49	47	46	39	
34" x 34"	8.03			200	1536	-0.01	-	864 x 864	0.75			1.02	725	-0.4	27	12	-
		400	3071	-0.06	21	2.03	1449			-1.4	36	29	25	21	-	-	
		500	3839	-0.09	27	2.54	1812			-2.2	39	34	31	27	18	-	
		600	4607	-0.13	32	3.05	2174			-3.2	42	38	35	31	24	16	
		700	5374	-0.17	37	3.56	2536			-4.3	44	42	39	35	30	22	
		800	6142	-0.23	41	4.06	2899			-5.7	46	45	42	39	35	27	
		900	6910	-0.29	44	4.57	3261			-7.2	47	48	45	42	39	32	
		1000	7678	-0.36	47	5.08	3623			-8.9	49	50	47	45	43	36	
		1100	8445	-0.43	50	5.59	3986			-10.7	50	52	49	47	46	40	
		36" x 34"	8.50	200	1628	-0.01	-			914 x 864	0.79	1.02	768	-0.4	37	29	25
400	3256			-0.06	21	2.03	1537	-1.4	46			45	41	35	27	21	
500	4070			-0.09	27	2.54	1921	-2.2	50			50	46	41	35	30	
600	4884			-0.13	33	3.05	2305	-3.2	52			55	51	46	41	38	
700	5698			-0.17	37	3.56	2689	-4.3	54			58	54	50	47	44	
800	6511			-0.23	41	4.06	3073	-5.7	56			61	57	53	52	49	
900	7325			-0.29	45	4.57	3457	-7.2	58			64	60	56	56	54	
1000	8139			-0.36	48	5.08	3841	-8.9	59			67	63	59	60	58	
1100	8953			-0.43	50	5.59	4225	-10.7	60			69	65	62	63	62	
42" x 30"	8.75			200	1676	-0.01	-	1067 x 762	0.81			1.02	791	-0.4	37	29	25
		400	3352	-0.06	21	2.03	1582			-1.4	47	45	41	35	27	22	
		500	4189	-0.09	28	2.54	1977			-2.2	50	51	47	41	35	31	
		600	5027	-0.13	33	3.05	2373			-3.2	52	55	51	46	42	38	
		700	5865	-0.17	37	3.56	2768			-4.3	54	59	55	50	47	44	
		800	6703	-0.23	41	4.06	3164			-5.7	56	62	58	54	52	50	
		900	7541	-0.29	45	4.57	3559			-7.2	58	64	61	57	56	54	
		1000	8379	-0.36	48	5.08	3954			-8.9	59	67	63	59	60	59	
		1100	9217	-0.43	51	5.59	4350			-10.7	61	69	65	62	64	62	
		36" x 36"	9.00	200	1726	-0.01	-			914 x 914	0.84	1.02	814	-0.4	37	30	25
400	3452			-0.06	21	2.03	1629	-1.4	47			46	42	36	27	22	
500	4314			-0.09	28	2.54	2036	-2.2	50			51	47	41	35	31	
600	5177			-0.13	33	3.05	2443	-3.2	52			55	51	46	42	39	
700	6040			-0.17	38	3.56	2851	-4.3	55			59	55	50	48	45	
800	6903			-0.23	42	4.06	3258	-5.7	56			62	58	54	52	50	
900	7766			-0.29	45	4.57	3665	-7.2	58			65	61	57	57	55	
1000	8629			-0.36	48	5.08	4072	-8.9	59			67	63	60	60	59	
1100	9492			-0.43	51	5.59	4480	-10.7	61			69	66	62	64	63	

NOTES: NC values are based on octave band 2 - 7 sound power levels minus a room absorption of 10dB, re 10⁻¹² Watts. Dash in space denotes a NC or dB value of less than 10. Data was obtained from tests conducted in accordance with ANSI/ASHRAE Standard 70, ISO Standard 5219, and ISO Standard 3741. See Krueger's selection program for performance data not shown, including octave band data.

S80 / S580 / S85 / S585 SERIES



Return Grille | Single, Fixed Deflection

PERFORMANCE DATA | S80, S580 | 0° DEFLECTION (NO DAMPER)

		IP DATA				NC	METRIC DATA					OCTAVE BAND, dB						
NOM DUCT	DUCT AREA	NECK VEL	AIRFLOW	Ps	NOM DUCT		DUCT AREA	NECK VEL	AIRFLOW	Ps	2	3	4	5	6	7		
in	ft ²	FPM	CFM	"WG	mm	m ²	m/s	L/s	Pa									
48" x 30"	10.00	200	1920	-0.01	-	1219 x 762	0.93	1.02	906	-0.4	38	31	26	18	-	-		
		400	3839	-0.06	22			2.03	1812	-1.4	47	47	43	36	28	24		
		500	4799	-0.09	29			2.54	2265	-2.2	51	52	48	42	36	33		
		600	5759	-0.13	34			3.05	2718	-3.2	53	56	52	47	43	40		
		700	6718	-0.17	39			3.56	3171	-4.3	55	60	56	51	49	46		
		800	7678	-0.23	42			4.06	3624	-5.7	57	63	59	55	54	52		
		900	8638	-0.29	46			4.57	4077	-7.2	59	66	62	58	58	56		
		1000	9598	-0.36	49			5.08	4530	-8.9	60	68	64	61	62	60		
		1100	10557	-0.43	52			5.59	4983	-10.7	61	71	67	63	65	64		
		38" x 38"	10.03	200	1927			-0.01	-	965 x 965	0.93	1.02	910	-0.4	38	31	26	18
400	3854			-0.06	22	2.03	1819	-1.4	47			47	43	37	28	24		
500	4818			-0.09	29	2.54	2274	-2.2	51			52	48	42	36	33		
600	5782			-0.13	34	3.05	2729	-3.2	53			56	52	47	43	40		
700	6745			-0.17	39	3.56	3183	-4.3	55			60	56	51	49	46		
800	7709			-0.23	42	4.06	3638	-5.7	57			63	59	55	54	52		
900	8672			-0.29	46	4.57	4093	-7.2	59			66	62	58	58	56		
1000	9636			-0.36	49	5.08	4548	-8.9	60			68	64	61	62	61		
1100	10599			-0.43	52	5.59	5002	-10.7	62			71	67	63	65	64		
42" x 36"	10.50			200	2020	-0.01	-	1067 x 914	0.98			1.02	953	-0.4	38	31	27	19
		400	4039	-0.06	23	2.03	1906			-1.4	48	47	43	37	29	24		
		500	5049	-0.09	29	2.54	2383			-2.2	51	53	48	43	37	33		
		600	6059	-0.13	35	3.05	2859			-3.2	53	57	53	48	44	41		
		700	7068	-0.17	39	3.56	3336			-4.3	56	60	56	52	49	47		
		800	8078	-0.23	43	4.06	3812			-5.7	57	64	60	55	54	52		
		900	9088	-0.29	46	4.57	4289			-7.2	59	66	62	58	58	57		
		1000	10098	-0.36	49	5.08	4766			-8.9	60	69	65	61	62	61		
		1100	11107	-0.43	52	5.59	5242			-10.7	62	71	67	64	66	65		
		46" x 34"	10.86	200	2090	-0.01	-			1168 x 864	1.01	1.02	986	-0.4	38	31	27	19
400	4179			-0.06	23	2.03	1972	-1.4	48			48	43	37	29	25		
500	5224			-0.09	29	2.54	2466	-2.2	51			53	49	43	37	34		
600	6269			-0.13	35	3.05	2959	-3.2	54			57	53	48	44	41		
700	7314			-0.17	39	3.56	3452	-4.3	56			61	57	52	50	47		
800	8359			-0.23	43	4.06	3945	-5.7	58			64	60	55	54	53		
900	9404			-0.29	47	4.57	4438	-7.2	59			67	63	59	59	57		
1000	10448			-0.36	50	5.08	4931	-8.9	61			69	65	61	63	62		
1100	11493			-0.43	52	5.59	5424	-10.7	62			71	67	64	66	65		
42" x 38"	11.08			200	2134	-0.01	-	1067 x 965	1.03			1.02	1007	-0.4	36	12	-	-
		400	4268	-0.06	23	2.03	2014			-1.4	46	28	25	20	-	-		
		500	5335	-0.09	30	2.54	2518			-2.2	39	33	30	26	17	-		
		600	6402	-0.13	35	3.05	3022			-3.2	41	38	34	31	24	15		
		700	7469	-0.17	39	3.56	3525			-4.3	44	41	38	35	29	21		
		800	8536	-0.23	43	4.06	4029			-5.7	45	44	41	38	34	26		
		900	9604	-0.29	47	4.57	4532			-7.2	47	47	44	42	38	31		
		1000	10671	-0.36	50	5.08	5036			-8.9	49	50	47	44	42	35		
		1100	11738	-0.43	53	5.59	5540			-10.7	50	52	49	47	46	39		
		40" x 40"	11.11	200	2140	-0.01	-			1016 x 1016	1.03	1.02	1010	-0.4	27	12	-	-
400	4279			-0.06	23	2.03	2020	-1.4	36			29	25	21	-	-		
500	5349			-0.09	30	2.54	2525	-2.2	39			34	31	27	18	-		
600	6419			-0.13	35	3.05	3029	-3.2	42			38	35	31	24	16		
700	7489			-0.17	39	3.56	3534	-4.3	44			42	39	35	30	22		
800	8559			-0.23	43	4.06	4039	-5.7	46			45	42	39	35	27		
900	9629			-0.29	47	4.57	4544	-7.2	47			48	45	42	39	32		
1000	10698			-0.36	50	5.08	5049	-8.9	49			50	47	45	43	36		
1100	11768			-0.43	53	5.59	5554	-10.7	50			52	49	47	46	40		

NOTES: NC values are based on octave band 2 - 7 sound power levels minus a room absorption of 10dB, re 10⁻¹² Watts. Dash in space denotes a NC or dB value of less than 10. Data was obtained from tests conducted in accordance with ANSI/ASHRAE Standard 70, ISO Standard 5219, and ISO Standard 3741. See Krueger's selection program for performance data not shown, including octave band data.

PERFORMANCE DATA | S80, S580 | 0° DEFLECTION (NO DAMPER)

		IP DATA				NC	METRIC DATA					OCTAVE BAND, dB						
NOM DUCT	DUCT AREA	NECK VEL	AIRFLOW	Ps	NOM DUCT		DUCT AREA	NECK VEL	AIRFLOW	Ps								
in	ft ²	FPM	CFM	"WG	mm		m ²	m/s	L/s	Pa	2	3	4	5	6	7		
48" x 36"	12.00	200	2313	-0.01	-	1219 x 914	1.11	1.02	1092	-0.4	39	32	28	20	-	-		
		350	4048	-0.04	20			1.78	1911	-1.1	47	46	41	35	25	21		
		400	4627	-0.06	24			2.03	2183	-1.4	49	49	44	38	30	26		
		500	5783	-0.09	30			2.54	2729	-2.2	52	54	50	44	38	35		
		600	6940	-0.13	36			3.05	3275	-3.2	54	58	54	49	45	43		
		700	8096	-0.17	40			3.56	3821	-4.3	56	62	58	53	51	49		
		800	9253	-0.23	44			4.06	4367	-5.7	58	65	61	56	55	54		
		900	10410	-0.29	47			4.57	4913	-7.2	60	68	64	59	60	59		
		1000	11566	-0.36	50			5.08	5459	-8.9	61	70	66	62	64	63		
		42" x 42"	12.25	200	2363			-0.01	-	1067 x 1067	1.14	1.02	1115	-0.4	39	33	28	20
350	4136			-0.04	20	1.78	1952	-1.1	47			46	41	35	26	21		
400	4727			-0.06	24	2.03	2231	-1.4	49			49	45	38	31	27		
500	5908			-0.09	30	2.54	2788	-2.2	52			54	50	44	39	35		
600	7090			-0.13	36	3.05	3346	-3.2	54			58	54	49	45	43		
700	8271			-0.17	40	3.56	3904	-4.3	57			62	58	53	51	49		
800	9453			-0.23	44	4.06	4461	-5.7	58			65	61	57	56	54		
900	10635			-0.29	48	4.57	5019	-7.2	60			68	64	60	60	59		
1000	11816			-0.36	51	5.08	5577	-8.9	61			70	66	62	64	63		
44" x 44"	13.44			200	2598	-0.01	-	1118 x 1118	1.25			1.02	1226	-0.4	40	34	29	21
		350	4547	-0.04	21	1.78	2146			-1.1	47	47	42	36	27	22		
		400	5196	-0.06	25	2.03	2452			-1.4	49	50	45	39	32	28		
		500	6495	-0.09	31	2.54	3065			-2.2	52	55	51	45	40	37		
		600	7794	-0.13	37	3.05	3678			-3.2	55	59	55	50	46	44		
		700	9093	-0.17	41	3.56	4291			-4.3	57	63	59	54	52	50		
		800	10392	-0.23	45	4.06	4904			-5.7	59	66	62	57	57	56		
		900	11691	-0.29	48	4.57	5518			-7.2	61	69	65	61	61	60		
		1000	12990	-0.36	51	5.08	6131			-8.9	62	71	67	63	65	65		
		48" x 42"	14.00	200	2707	-0.01	-			1219 x 1067	1.30	1.02	1278	-0.4	40	34	29	21
350	4737			-0.04	21	1.78	2236	-1.1	48			47	43	36	27	23		
400	5414			-0.06	25	2.03	2555	-1.4	50			50	46	39	32	28		
500	6768			-0.09	32	2.54	3194	-2.2	53			56	51	45	40	37		
600	8121			-0.13	37	3.05	3833	-3.2	55			60	56	50	47	45		
700	9475			-0.17	41	3.56	4472	-4.3	57			63	59	54	52	51		
800	10828			-0.23	45	4.06	5110	-5.7	59			67	62	58	57	56		
900	12182			-0.29	49	4.57	5749	-7.2	61			69	65	61	61	61		
1000	13535			-0.36	52	5.08	6388	-8.9	62			72	68	64	65	65		
46" x 46"	14.69			200	2844	-0.01	-	1168 x 1168	1.37			1.02	1342	-0.4	40	35	30	22
		350	4977	-0.04	22	1.78	2349			-1.1	48	48	43	36	28	24		
		400	5688	-0.06	25	2.03	2684			-1.4	50	51	46	40	32	29		
		500	7110	-0.09	32	2.54	3355			-2.2	53	56	52	46	41	38		
		600	8532	-0.13	37	3.05	4026			-3.2	56	60	56	51	47	45		
		700	9953	-0.17	42	3.56	4697			-4.3	58	64	60	55	53	52		
		800	11375	-0.23	46	4.06	5369			-5.7	60	67	63	58	58	57		
		900	12797	-0.29	49	4.57	6040			-7.2	61	70	66	61	62	62		
		1000	14219	-0.36	52	5.08	6711			-8.9	63	72	68	64	66	66		
		48" x 46"	15.33	200	2970	-0.01	-			1219 x 1168	1.42	1.02	1401	-0.4	41	35	30	22
350	5197			-0.04	22	1.78	2453	-1.1	48			48	44	37	28	24		
400	5939			-0.06	26	2.03	2803	-1.4	50			51	47	40	33	30		
500	7424			-0.09	32	2.54	3504	-2.2	53			56	52	46	41	39		
600	8909			-0.13	38	3.05	4204	-3.2	56			61	56	51	48	46		
700	10393			-0.17	42	3.56	4905	-4.3	58			64	60	55	53	52		
800	11878			-0.23	46	4.06	5606	-5.7	60			67	63	59	58	57		
900	13363			-0.29	49	4.57	6307	-7.2	61			70	66	62	62	62		
1000	14848			-0.36	52	5.08	7007	-8.9	63			73	69	64	66	66		

NOTES: NC values are based on octave band 2 - 7 sound power levels minus a room absorption of 10dB, re 10⁻¹² Watts. Dash in space denotes a NC or dB value of less than 10. Data was obtained from tests conducted in accordance with ANSI/ASHRAE Standard 70, ISO Standard 5219, and ISO Standard 3741. See Krueger's selection program for performance data not shown, including octave band data.

S80 / S580 / S85 / S585 SERIES



Return Grille | Single, Fixed Deflection

PERFORMANCE DATA | S80, S580 | 0° DEFLECTION (NO DAMPER)

NOM DUCT	DUCT AREA	IP DATA			NC	METRIC DATA					OCTAVE BAND, dB					
		NECK VEL	AIRFLOW	Ps		NOM DUCT	DUCT AREA	NECK VEL	AIRFLOW	Ps	2	3	4	5	6	7
in	ft ²	FPM	CFM	"WG		mm	m ²	m/s	L/s	Pa						
48" x 48"	16.00	200	3101	-.001	-	1219 x 1219	1.49	1.02	1463	-0.4	41	35	31	22	-	-
		350	5426	-.004	22			1.78	2561	-1.1	49	49	44	37	29	25
		400	6202	-.006	26			2.03	2927	-1.4	50	52	47	41	33	30
		500	7752	-.009	33			2.54	3659	-2.2	54	57	52	47	41	39
		600	9302	-.013	38			3.05	4390	-3.2	56	61	57	51	48	46
		700	10853	-.017	42			3.56	5122	-4.3	58	65	60	55	54	53
		800	12403	-.023	46			4.06	5854	-5.7	60	68	64	59	59	58
		900	13954	-.029	50			4.57	6585	-7.2	62	71	66	62	63	63
		1000	15504	-.036	53			5.08	7317	-8.9	63	73	69	65	67	67

NOTES: NC values are based on octave band 2 - 7 sound power levels minus a room absorption of 10dB, re 10⁻¹² Watts. Dash in space denotes a NC or dB value of less than 10. Data was obtained from tests conducted in accordance with ANSI/ASHRAE Standard 70, ISO Standard 5219, and ISO Standard 3741. See Krueger's selection program for performance data not shown, including octave band data.

ENGINEERING SPECIFICATION & CONFIGURATION

S80, S580

The return grille shall be a Krueger model S80 (steel) or S580 (aluminum). This grille must have 35° deflection (H and V models) or 0° deflection (HZ and VZ models) blades on 3/4" centers made of 22 gage steel (S80) or roll formed aluminum (S580). The blades must be held in place by mullions placed behind the grille and welded to the frame. The frame of the grille must be constructed of 22 gage steel (S80) or roll formed aluminum with minimum 0.032" thickness (S580) for sizes less than and equal to 24"x24" and extruded aluminum with nominal thickness 0.040 - 0.050" for sizes greater than 24"x24" with countersunk screw holes. This frame must also produce a border of 1 1/4" around all sides of the grille with mitered corners.

Optional damper shall be available made of heavy gage steel (OBD) or aluminum (5OBD) and operable from the face of the return grille.

S85, S585

The return grille shall be a Krueger model S85 (steel) or S585 (aluminum). This grille must have 35° deflection (H and V models) or 0° deflection (HZ and VZ models) blades on 1/2" centers made of 22 gage steel (S85) or roll formed aluminum (S585). The blades must be held in place by mullions placed behind the grille and welded to the frame. The frame of the grille must be constructed of 22 gage steel (S85) or roll formed aluminum with minimum 0.032" thickness (S585) for sizes less than and equal to 24"x24" and extruded aluminum with nominal thickness 0.040 - 0.050" for sizes greater than 24"x24" with countersunk screw holes. This frame must also produce a border of 1 1/4" around all sides of the grille with mitered corners.

Optional damper shall be available made of heavy gage steel (OBD/POBD) or aluminum (5OBD) and operable from the face of the return grille.

PERFORMANCE

The manufacturer shall provide published (printed or electronic) performance data for the diffuser. Performance data shall include 2 - 7 octave band sound power levels. The diffuser shall be tested in accordance to the data standards at the time of product introduction or ANSI/ASHRAE Standard 70.

FINISH

The paint finish shall be #44 British White and be an anodic acrylic paint, baked at 315°F for 30 minutes. The paint thickness shall be 0.8 - 1.0 mils, gloss at 60° per ASTM D523-89 of 50 - 85%, pencil hardness per ASTM D3363-92A of HB - H, crosshatch adhesion per ASTM D3359-83 of 4B - 5B, impact per ASTM D2794-93 of direct impact >100 in/lb and reverse impact >80 in/lb, salt spray per ASTM B117-9048 of 96 hours, humidity per ASTM D2247-92 of >500 hours and water soak per ASTM D870-92 of 250 hours.

1. SERIES: (XXXX)

- S80 - Single fixed deflection, 3/4" spacing, steel return grille
- S580 - Single fixed deflection, 3/4" spacing, aluminum return grille
- S85 - Single fixed deflection, 1/2" spacing, steel return grille
- S585 - Single fixed deflection, 1/2" spacing, aluminum return grille

2. PATTERN: (XX)

- H - 35° horizontal front blades
- V - 35° vertical front blades
- HZ - 0° horizontal front blades
- VZ - 0° vertical front blades

3. WIDTH: (XX)*

- 6" - 240" in 1/4" increments

4. HEIGHT: (XX)*

- 4" - 240" in 1/4" increments

5. FRAME: (XXX)

- F22 - Surface mount
- F23 - Lay-in T-bar
- F98 - Narrow-T **

6. PANEL: (XX)x(XX)

- | | |
|---------|---------|
| NONE | 24"x12" |
| 24"x24" | 48"x24" |

7. FASTENING METHOD: (XX)

- 00 - No screw holes
- 01 - Standard screw holes
- 02 - Concealed fastening
- 03 - Knurled knob ***
- 08 - 1/4 turn fasteners ***

8. DAMPER: (XX)

- 00 - No damper
- 01 - Steel opposed blade damper (model OBD)
- 13 - Painted opposed blade damper (model POBD)
- 15 - Aluminum opposed blade damper (model 5OBD)

9. ACCESSORIES: (XX) (XX)

- 00 - No accessories
- 01 - Plaster frame
- 04 - 1" filter ***
- 05 - 2" filter ***

10. FINISH: (XX)

- | | |
|------------|--------------------|
| 01 - Mill | 10 - Alumican |
| 35 - Black | 44 - British White |

* Maximum single piece unit size is 240"x96" or 96"x240".

** Frame 98 only available with 24"x24" and 24"x12" panel.

*** Knurled knob and 1/4 turn fastening methods are only available with filter frame accessories.

SAMPLE CONFIGURATION: S80 - HZ - 10x12 - F22 - NONE - 01 - 15 - 00 - 00 - 01