



	<p>PRISM This supply diffuser features an arcuate faceplate. Center square appliqué offers nine standard colors to match interior décor.</p>
	<p>PLQ & 5PLQ This supply diffuser features a square plaque faceplate.</p>
	<p>PLQR This supply diffuser features a round plaque faceplate.</p>
	<p>PLQLT This supply diffuser features a square plaque face plate and insulated backpan for low-temperature applications.</p>
	<p>PLQIMP This supply diffuser features a square plaque faceplate with an integrated multi-port ring.</p>
	<p>KSD This architectural supply diffuser features a center swirl.</p>

PRISM

Introduction A1-3
 Dimensional & Appliqué Information A1-4
 Retrofit Installation Information A1-5
 Reference Charts A1-6
 Performance Data A1-9
 Engineering Specification..... A1-11

PLQ, 5PLQ, PLQR, PLQLT, 5PLQLT

PLQ/5PLQ/PLQR Introduction & Dimensional Information..... A1-12
 PLQ/5PLQ/PLQR Frame Styles & Directional Blow Tabs..... A1-13
 PLQLT/5PLQLT Introduction..... A1-14
 PLQLT/5PLQLT Dimensional Information & Frame Styles..... A1-15
 PLQ/5PLQ/PLQLT/5PLQLT Reference Charts A1-16
 PLQ/5PLQ/PLQLT/5PLQLT Performance Data A1-19
 PLQR Reference Charts..... A1-21
 PLQR Performance Data A1-24
 Engineering Specifications..... A1-26

PLQIMP

Introduction A1-28
 Dimensional Information & Frame Styles..... A1-29
 Reference Charts A1-30
 Performance Data A1-32
 Engineering Specifications..... A1-33

KSD

Introduction & Dimensional Data..... A1-34
 Reference Charts A1-35
 Performance Data A1-37
 Engineering Specification..... A1-38

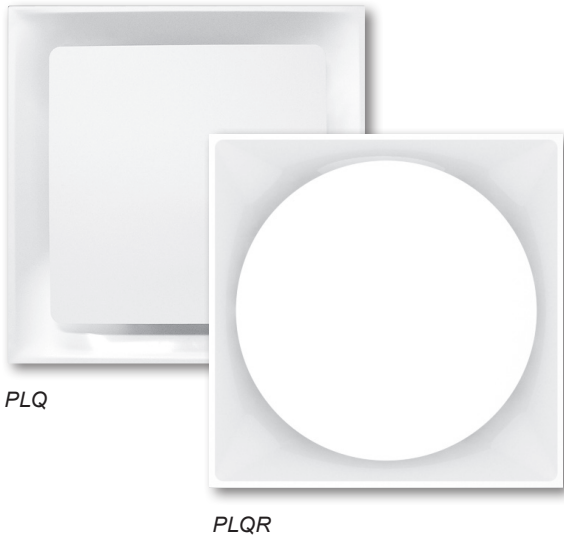

Introduction: PLQ, 5PLQ, PLQR

The PLQ/5PLQ architectural ceiling diffuser provides the building designer with the desired appearance and superior performance of a uniform radial discharge air pattern. A 360° horizontal pattern delivers even air throughout the space.

The 24"x24" PLQ/5PLQ has a square faceplate made of one-piece, nonfolded material with rounded corners to give the diffuser a clean appearance that is unobtrusive to ceiling systems. (Round faceplate available with model PLQR that provides an expanding square discharge air pattern.) The single faceplate gives the diffuser reduced pressure drops and a quiet sound profile and is held in place by hooks that lock into the backpan. The one-piece, stamped backpan provides smooth, consistent corners, exacting dimensions, and performance tolerances. The removable faceplate offers easy duct and damper access.

The 12"x12" PLQ and PLQR have the same construction as the 24"x24" panel size models.

MODELS

- PLQ - Square Plaque, Round Neck, Steel Construction
- 5PLQ - Square Plaque, Round Neck, Aluminum Construction
- PLQR - Round Plaque, Round Neck, Steel Construction

ACCESSORIES

- Dampers
- Straightening Grid

PANEL SIZES

- 12"x12" (Plaque drops 1/4" below ceiling.)
- 24"x24" (Plaque drops 1/4" below ceiling.)

FINISHES

- Standard finish is #44 British White.
- Optional finishes available.

PLQ, 5PLQ, PLQR Dimensional Information

PLQ, 5PLQ, FACE VIEW

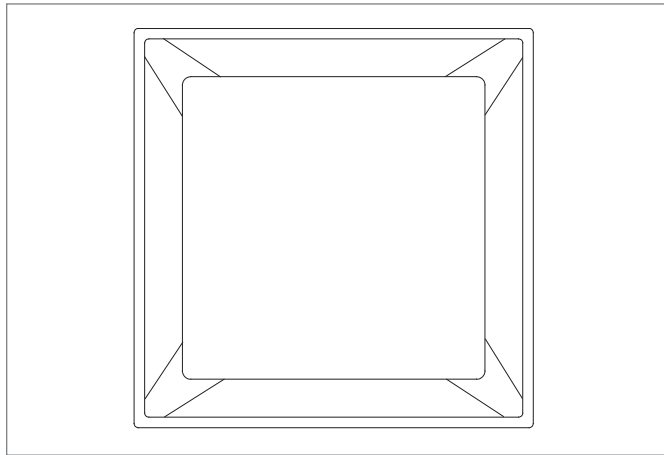

PLQR, FACE VIEW

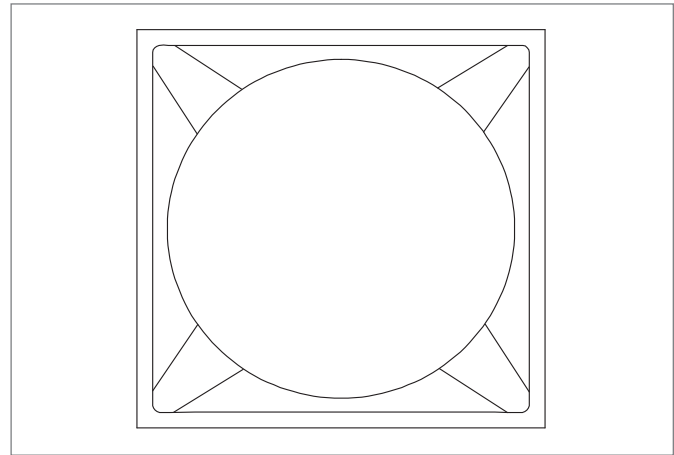

PLQ, PLQR, 12"x12" PANEL SIDE VIEW

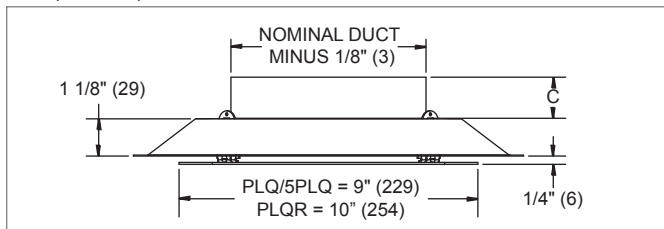

PLQ, 5PLQ, PLQR, 24"x24" PANEL SIDE VIEW

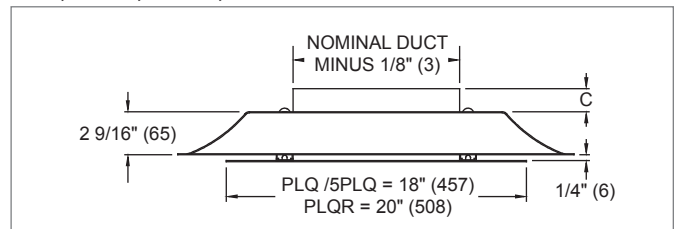

NOTES: Dimensions in parentheses are mm. See tables on next page for value of 'C'.

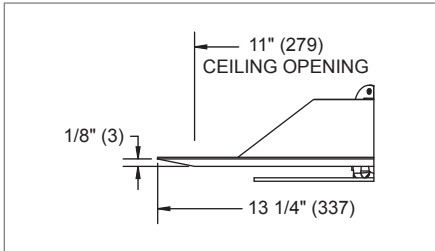
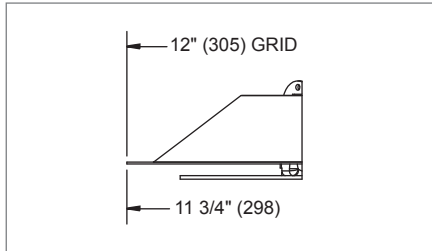
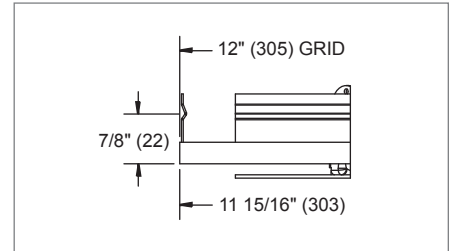
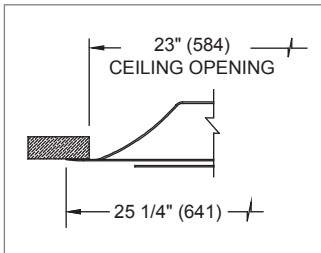
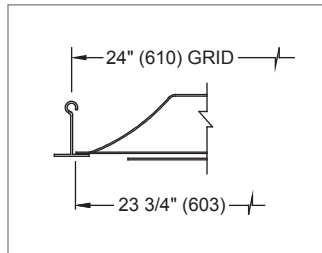
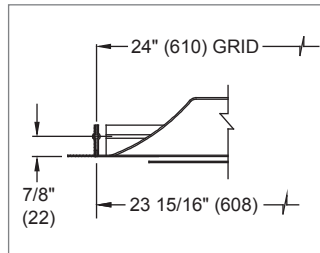
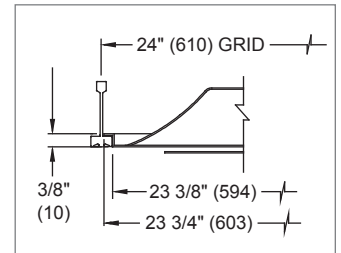
PLQ, 5PLQ, PLQR Frame Styles
**PLQ, PLQR, 5PLQ
FRAME 22, 12"x12" PANEL
SURFACE MOUNT**

**PLQ, PLQR, 5PLQ
FRAME 23, 12"x12" PANEL
LAY-IN T-BAR**

**PLQ, PLQR
FRAME 24, 12"x12" PANEL
SNAP-IN T-BAR**

**PLQ, 5PLQ, PLQR,
FRAME 22, 24"x24"
PANEL, SURFACE MOUNT**

**PLQ, 5PLQ, PLQR,
FRAME 23, 24"x24"
PANEL, LAY-IN T-BAR**

**PLQ, PLQR,
FRAME 24, 24"x24"
PANEL, SNAP-IN T-BAR**

**PLQ, 5PLQ, PLQR,
FRAME 98, 24"x24"
PANEL, NARROW-T**

PLQ, 5PLQ, PLQR, AVAILABLE FRAMES

Frame Style	Panel Size	PLQ	5PLQ	PLQR
Frame 22	12" x 12"	x	x	x
	24" x 24"	x	x	x
Frame 23	12" x 12"	x	x	x
	24" x 24"	x	x	x
Frame 24	12" x 12"	x	-	x
	24" x 24"	x	-	x
Frame 98	12" x 12"	-	-	-
	24" x 24"	x	x	x

PLQ, 5PLQ, PLQR, AVAILABLE NECK SIZES

12" x 12" Panel	
Nominal Duct Size	C
6" (152)	1 1/8" (29)
7" (178)	1 1/8" (29)
8" (203)	1 1/4" (32)

See previous page, Side Views, for references to dimension 'C'.

24" x 24" Panel	
Nominal Duct Size	C
6" (152)	1 1/8" (29)
8" (203)	1 1/4" (32)
10" (254)	1 3/8" (35)
12" (305)	1 3/8" (35)
14" (356)	1 3/8" (35)
15" (381)	1 3/8" (35)

Dimensions in parentheses are mm. Dash indicates not available.

Reference charts, performance data, and engineering specifications are continued, beginning on page A1-16.

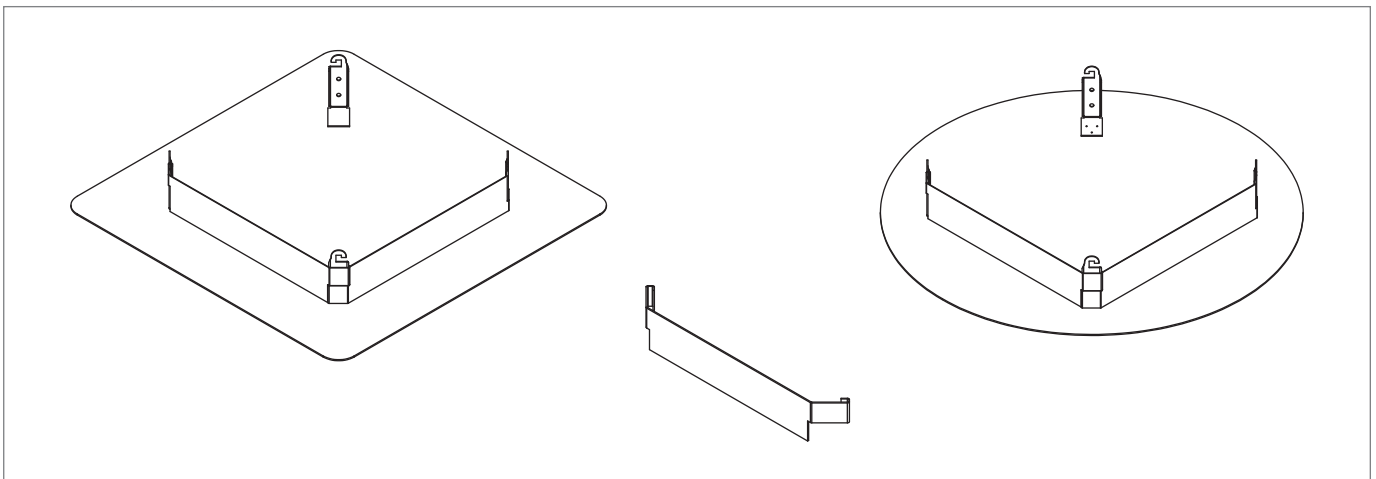
PLQ, 5PLQ, PLQR Directional Blow Tabs (DBT & 5DBT)
PLQ, 5PLQ, PLQR, 12"x12" & 24"x24" PANELS

PLQR Reference Charts

AIRFLOW VS. NC LEVEL: PLQR, 12"x12" PANEL (NO DAMPER)

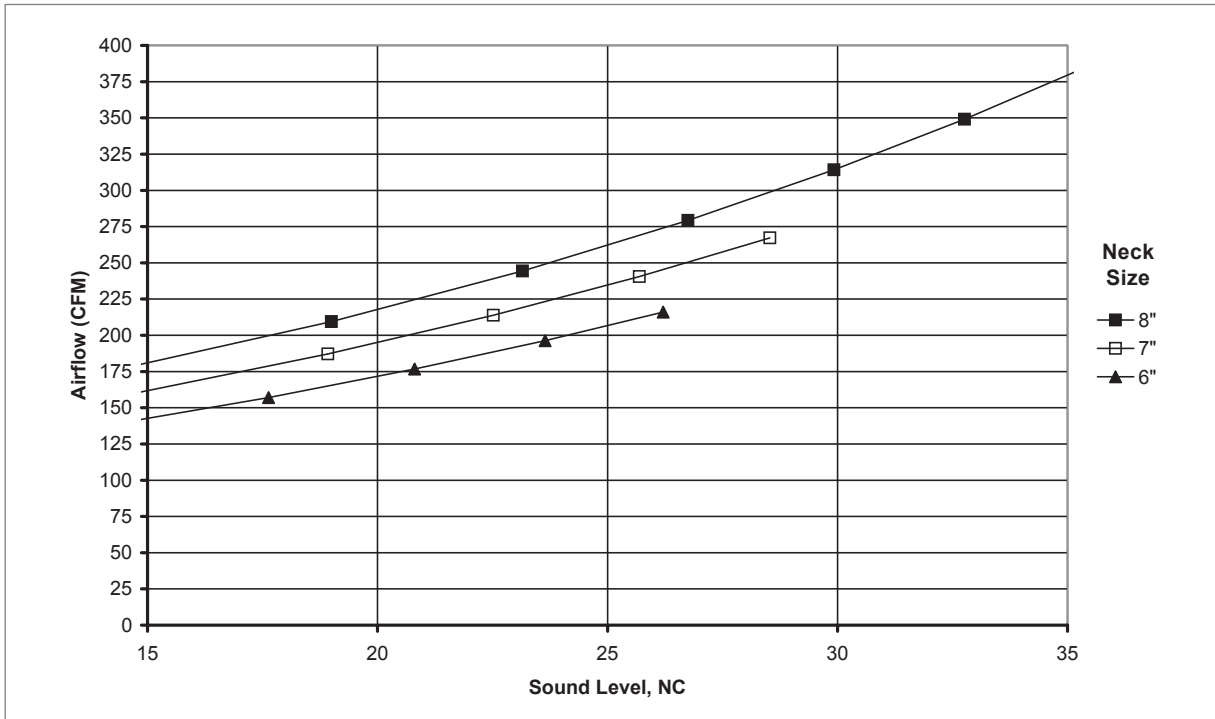

AIRFLOW VS. NC LEVEL: PLQR, 24"x24" PANEL (NO DAMPER)

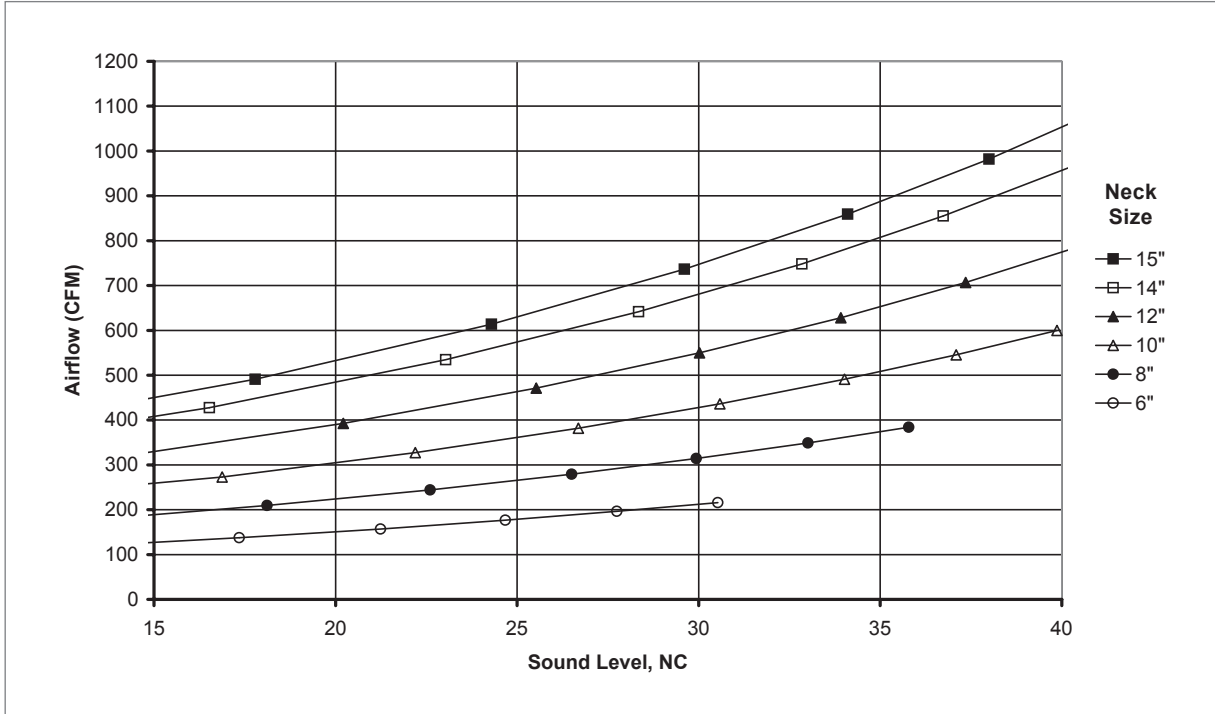

PLQR Reference Charts: Horizontal Throw

DIFFUSER SPACING FOR 80% ADPI: PLQR, 12"x12" PANEL, 6" NECK, 4-WAY (NO DAMPER)

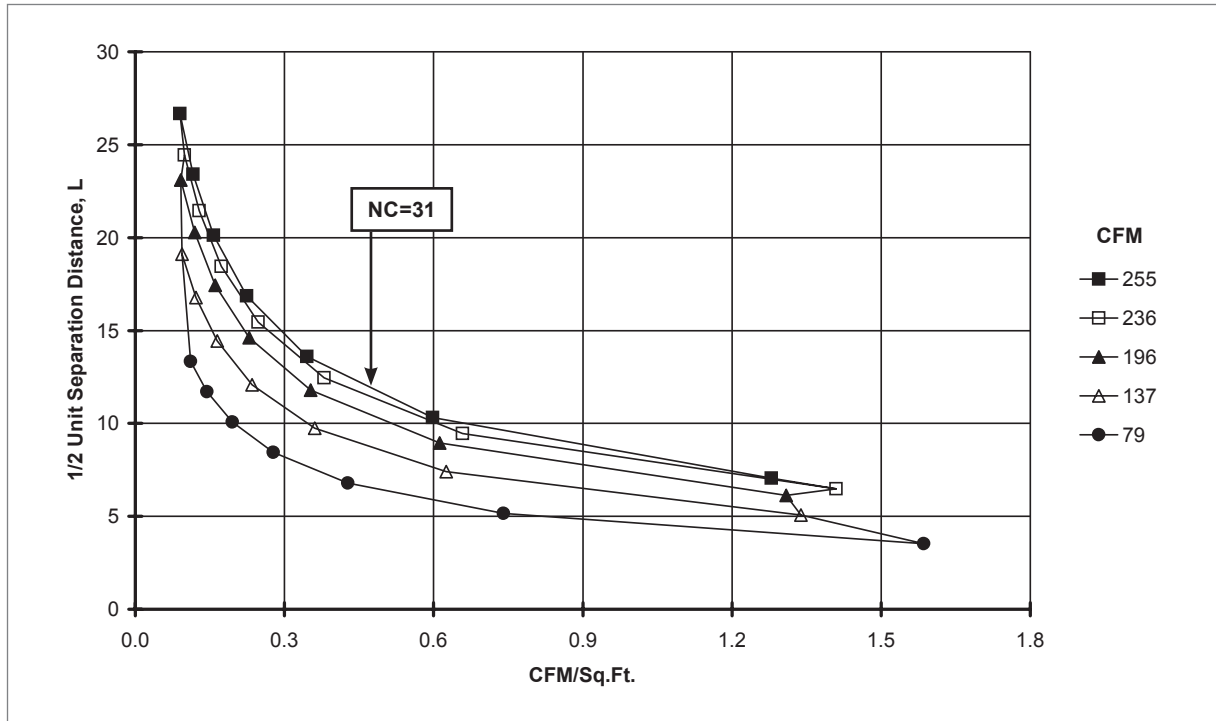

DIFFUSER SPACING FOR 80% ADPI: PLQR, 12"x12" PANEL, 8" NECK, 4-WAY (NO DAMPER)

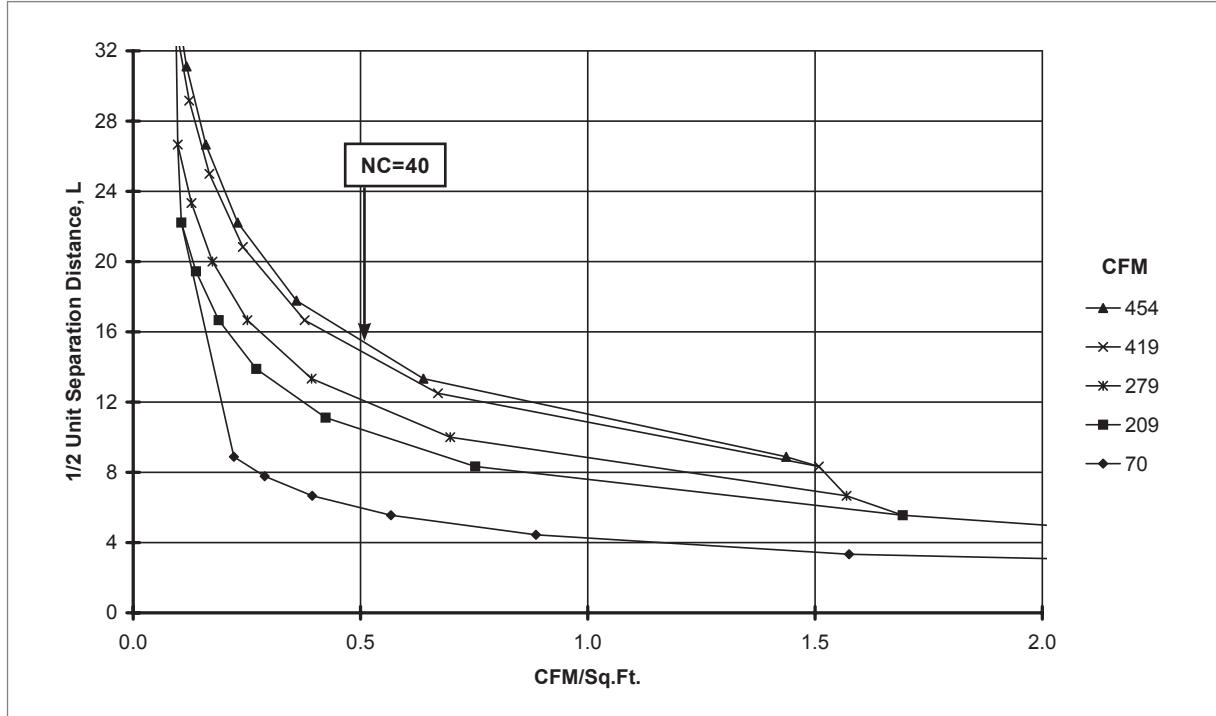

NOTES: Charts are at 20 BTUH/ft² loads. See the Engineering section of this catalog for instructions on how to read these charts and additional ADPI information.

PLQR Reference Charts: Horizontal Throw

DIFFUSER SPACING FOR 80% ADPI: PLQR, 24"x24" PANEL, 8" NECK, 4-WAY (NO DAMPER)

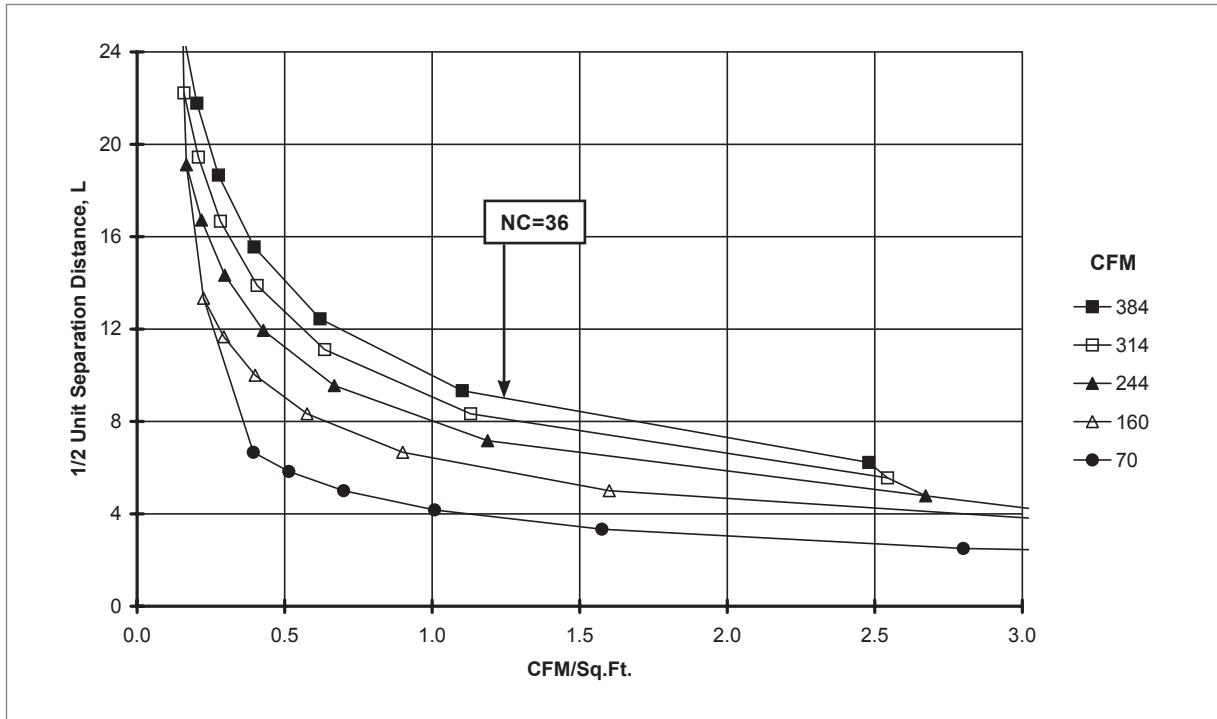

DIFFUSER SPACING FOR 80% ADPI: PLQR, 24"x24" PANEL, 14" NECK, 4-WAY (NO DAMPER)

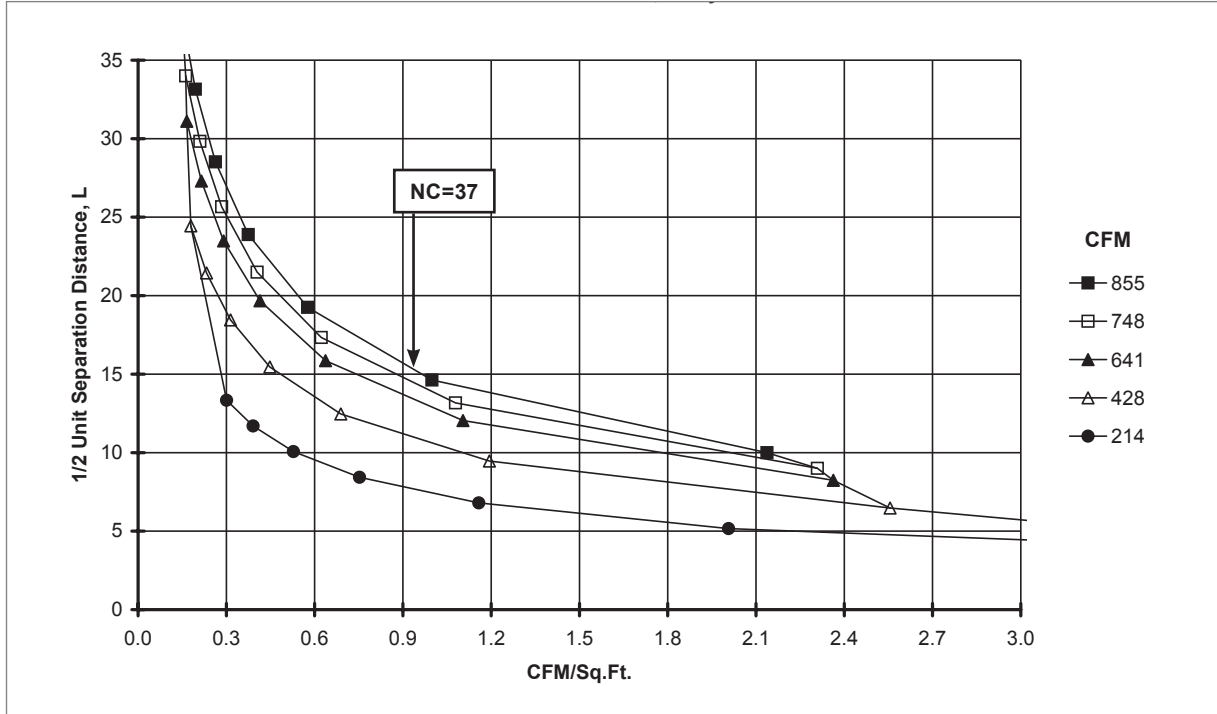

NOTES: Charts are at 20 BTUH/ft² loads. See the Engineering section of this catalog for instructions on how to read these charts and additional ADPI information.

PLQR Performance Data: Horizontal Throw

IP/METRIC DATA: PLQR, 12"x12" PANEL, ROUND NECK (NO DAMPER)

ARCHITECTURAL & PLAQUE DIFFUSERS

	IP Data					NC	Metric Data					Octave Band, dB					
	Neck Vel	Air Flow	Ps	Pt	Throw		Neck Vel	Air Flow	Ps	Pt	Throw						
	FPM	CFM	"WG	"WG	ft		m/s	L/s	Pa	Pa	m	2	3	4	5	6	7
6" Dia.	200	39	0.004	.006	0 - 1 - 3	-	1.02	19	0.9	1.5	0.1 - 0.3 - 0.8	20	-	-	-	-	-
	300	59	0.008	.014	1 - 2 - 4	-	1.52	28	2.1	3.5	0.3 - 0.6 - 1.3	26	17	12	-	-	-
	500	98	0.023	.039	2 - 3 - 7	-	2.54	46	5.8	9.7	0.7 - 1.1 - 2.1	33	28	24	16	-	-
	600	118	0.033	.056	3 - 4 - 8	-	3.05	56	8.3	13.9	0.8 - 1.3 - 2.4	36	31	28	20	11	-
	700	137	0.046	.076	3 - 5 - 9	14	3.56	65	11.3	18.9	1.0 - 1.5 - 2.6	38	35	31	24	17	-
	800	157	0.059	.099	4 - 6 - 9	18	4.06	74	14.8	24.7	1.1 - 1.7 - 2.8	40	37	35	28	21	13
	900	177	0.075	.126	4 - 6 - 10	21	4.57	83	18.7	31.3	1.3 - 1.9 - 2.9	42	40	37	31	25	17
	1000	196	0.093	.155	5 - 7 - 10	24	5.08	93	23.1	38.7	1.4 - 2.1 - 3.1	44	42	40	34	29	21
	1100	216	0.112	.188	5 - 8 - 11	26	5.59	102	28.0	46.8	1.5 - 2.3 - 3.3	45	44	42	36	32	24
7" Dia.	200	53	0.008	.010	1 - 1 - 3	-	1.02	25	1.9	2.5	0.2 - 0.4 - 1.0	22	12	-	-	-	-
	300	80	0.017	.023	1 - 2 - 5	-	1.52	38	4.3	5.7	0.4 - 0.7 - 1.5	28	20	16	-	-	-
	500	134	0.048	.064	3 - 4 - 8	-	2.54	63	12.0	15.9	0.8 - 1.2 - 2.5	36	31	28	21	12	-
	600	160	0.069	.092	3 - 5 - 9	15	3.05	76	17.2	22.8	1.0 - 1.5 - 2.8	38	34	32	26	18	-
	700	187	0.094	.125	4 - 6 - 10	19	3.56	88	23.5	31.1	1.1 - 1.7 - 3.0	41	38	35	30	23	16
	800	214	0.123	.163	4 - 6 - 11	23	4.06	101	30.7	40.6	1.3 - 2.0 - 3.2	43	40	38	33	28	20
	900	241	0.156	.206	5 - 7 - 11	26	4.57	114	38.8	51.4	1.5 - 2.2 - 3.4	44	43	41	36	32	25
	1000	267	0.192	.255	5 - 8 - 12	29	5.08	126	47.9	63.4	1.6 - 2.5 - 3.6	46	45	43	39	35	28
	1100	294	0.233	.308	6 - 9 - 13	31	5.59	139	58.0	76.7	1.8 - 2.7 - 3.8	47	47	46	42	39	32
8" Dia.	200	70	0.012	.015	1 - 1 - 4	-	1.02	33	3.1	3.7	0.2 - 0.4 - 1.1	24	14	-	-	-	-
	300	105	0.028	.033	1 - 3 - 6	-	1.52	49	6.9	8.3	0.4 - 0.8 - 1.7	30	23	19	12	-	-
	500	175	0.077	.092	3 - 5 - 9	14	2.54	82	19.1	23.0	0.9 - 1.4 - 2.8	38	33	31	25	17	-
	600	209	0.111	.133	4 - 6 - 11	19	3.05	99	27.5	33.1	1.1 - 1.7 - 3.2	40	37	35	30	24	17
	700	244	0.150	.181	4 - 6 - 11	23	3.56	115	37.5	45.1	1.3 - 2.0 - 3.5	43	40	39	34	29	22
	800	279	0.197	.236	5 - 7 - 12	27	4.06	132	48.9	58.9	1.5 - 2.3 - 3.7	45	43	42	38	33	27
	900	314	0.249	.299	6 - 8 - 13	30	4.57	148	61.9	74.5	1.7 - 2.5 - 3.9	46	45	44	41	37	31
	1000	349	0.307	.369	6 - 9 - 14	33	5.08	165	76.5	92.0	1.9 - 2.8 - 4.1	48	48	47	43	41	35
	1100	384	0.372	.447	7 - 10 - 14	35	5.59	181	92.5	111.3	2.1 - 3.1 - 4.3	49	50	49	46	44	38

NOTES: Throw values are given for isothermal conditions and terminal velocities of 150, 100, and 50 FPM (0.75, 0.50, and 0.25 m/s). NC values are based on octave band 2 - 7 sound power levels minus a room absorption of 10dB, re 10⁻¹² Watts. Dash in space denotes a NC or dB value of less than 10. Nominal duct is duct width. Data was obtained from tests conducted in accordance with ANSI/ASHRAE Standard 70, ISO Standard 5219, and ISO Standard 3741. See Krueger's selection software for performance data not shown, including octave band data.

PLQR Performance Data: Horizontal Throw
IP/METRIC DATA: PLQR, 24"x24" PANEL, ROUND NECK (NO DAMPER)

	IP Data					NC	Metric Data					Octave Band, dB						
	Neck Vel	Air Flow	Ps	Pt	Throw		Neck Vel	Air Flow	Ps	Pt	Throw	2	3	4	5	6	7	
	FPM	CFM	"WG	"WG	ft		m/s	L/s	Pa	Pa	m							
6" Dia.	200	39	0.000	.003	0 - 0 - 2	-	1.02	19	0.1	0.7	0.1 - 0.1 - 0.5	23	14	-	-	-	-	
	300	59	0.001	.006	0 - 1 - 2	-	1.52	28	0.2	1.6	0.1 - 0.3 - 0.7	29	21	13	-	-	-	
	500	98	0.002	.017	1 - 2 - 4	-	2.54	46	0.4	4.3	0.4 - 0.6 - 1.2	36	31	26	14	-	-	
	600	118	0.002	.025	2 - 2 - 5	13	3.05	56	0.6	6.2	0.5 - 0.7 - 1.5	39	35	30	20	-	-	
	700	137	0.003	.034	2 - 3 - 6	17	3.56	65	0.8	8.4	0.6 - 0.9 - 1.7	41	38	34	25	12	-	
	800	157	0.004	.044	2 - 3 - 7	21	4.06	74	1.1	11.0	0.7 - 1.0 - 2.0	43	40	38	29	17	-	
	900	177	0.006	.056	2 - 4 - 7	25	4.57	83	1.4	14.0	0.7 - 1.1 - 2.2	45	42	41	33	22	14	
	1000	196	0.007	.069	3 - 4 - 8	28	5.08	93	1.7	17.2	0.8 - 1.2 - 2.4	46	44	43	36	25	17	
	1100	216	0.008	.084	3 - 4 - 8	31	5.59	102	2.1	20.8	0.9 - 1.4 - 2.5	48	46	46	39	29	20	
8" Dia.	200	70	0.002	.005	0 - 1 - 3	-	1.02	33	0.5	1.1	0.1 - 0.3 - 0.8	25	17	-	-	-	-	
	300	105	0.005	.010	1 - 2 - 4	-	1.52	49	1.1	2.5	0.3 - 0.6 - 1.2	31	25	17	-	-	-	
	500	175	0.012	.028	2 - 3 - 7	13	2.54	82	3.1	7.0	0.7 - 1.0 - 2.0	39	35	30	20	-	-	
	600	209	0.018	.040	3 - 4 - 8	18	3.05	99	4.5	10.1	0.8 - 1.2 - 2.4	42	38	35	26	14	-	
	700	244	0.024	.055	3 - 5 - 9	23	3.56	115	6.1	13.7	0.9 - 1.4 - 2.7	44	41	39	31	20	12	
	800	279	0.032	.072	4 - 5 - 9	27	4.06	132	8.0	17.9	1.1 - 1.6 - 2.9	46	44	42	35	25	16	
	900	314	0.040	.091	4 - 6 - 10	30	4.57	148	10.1	22.7	1.2 - 1.8 - 3.0	48	46	45	39	29	20	
	1000	349	0.050	.112	4 - 7 - 11	33	5.08	165	12.4	28.0	1.3 - 2.0 - 3.2	49	48	48	42	33	24	
	1100	384	0.060	.136	5 - 7 - 11	36	5.59	181	15.1	33.8	1.5 - 2.2 - 3.4	50	50	50	45	36	27	
10" Dia.	200	109	0.004	.007	1 - 2 - 4	-	1.02	51	1.1	1.7	0.2 - 0.5 - 1.1	28	20	-	-	-	-	
	300	164	0.009	.015	2 - 3 - 6	-	1.52	77	2.4	3.8	0.5 - 0.8 - 1.7	33	28	21	-	-	-	
	500	273	0.026	.042	3 - 5 - 9	17	2.54	129	6.6	10.4	0.9 - 1.4 - 2.8	41	37	34	25	13	-	
	600	327	0.038	.060	4 - 6 - 10	22	3.05	154	9.4	15.0	1.1 - 1.7 - 3.1	44	41	38	30	20	12	
	700	382	0.052	.082	4 - 6 - 11	27	3.56	180	12.9	20.5	1.3 - 2.0 - 3.4	46	44	42	35	25	17	
	800	436	0.067	.107	5 - 7 - 12	31	4.06	206	16.8	26.7	1.5 - 2.3 - 3.6	48	46	46	40	30	22	
	900	491	0.085	.136	6 - 8 - 13	34	4.57	232	21.3	33.8	1.7 - 2.5 - 3.8	50	49	49	43	35	25	
	1000	545	0.105	.168	6 - 9 - 13	37	5.08	257	26.2	41.8	1.9 - 2.8 - 4.0	51	51	51	47	38	29	
	1100	600	0.128	.203	7 - 10 - 14	40	5.59	283	31.8	50.5	2.1 - 3.0 - 4.2	53	53	54	50	42	32	
12" Dia.	200	157	0.007	.009	1 - 2 - 5	-	1.02	74	1.7	2.3	0.4 - 0.7 - 1.5	29	22	13	-	-	-	
	300	236	0.016	.021	2 - 4 - 7	-	1.52	111	3.9	5.3	0.7 - 1.1 - 2.2	35	30	23	12	-	-	
	400	314	0.028	.038	3 - 5 - 10	14	2.03	148	6.9	9.4	1.0 - 1.5 - 2.9	39	35	31	21	-	-	
	500	393	0.043	.059	4 - 6 - 11	20	2.54	185	10.8	14.7	1.2 - 1.8 - 3.4	43	40	36	28	18	11	
	600	471	0.062	.085	5 - 7 - 12	26	3.05	222	15.5	21.1	1.5 - 2.2 - 3.7	45	43	41	34	25	16	
	700	550	0.085	.115	6 - 8 - 13	30	3.56	259	21.1	28.7	1.7 - 2.6 - 4.0	48	46	45	39	30	21	
	800	628	0.111	.151	6 - 10 - 14	34	4.06	297	27.6	37.5	2.0 - 2.9 - 4.3	50	49	48	43	35	26	
	900	707	0.140	.191	7 - 11 - 15	37	4.57	334	34.9	47.5	2.2 - 3.2 - 4.6	51	51	51	47	39	29	
	1000	785	0.173	.236	8 - 11 - 16	40	5.08	371	43.1	58.6	2.4 - 3.4 - 4.8	53	53	54	50	43	33	
14" Dia.	200	214	0.010	.013	2 - 3 - 6	-	1.02	101	2.5	3.1	0.5 - 0.9 - 1.8	31	24	15	-	-	-	
	300	321	0.023	.028	3 - 4 - 9	-	1.52	151	5.7	7.1	0.9 - 1.4 - 2.7	37	32	26	15	-	-	
	400	428	0.041	.051	4 - 6 - 12	17	2.03	202	10.1	12.6	1.2 - 1.8 - 3.5	41	37	33	25	14	-	
	500	535	0.063	.079	5 - 7 - 13	23	2.54	252	15.8	19.6	1.5 - 2.3 - 4.0	44	42	39	32	22	14	
	600	641	0.091	.114	6 - 9 - 14	28	3.05	303	22.7	28.3	1.8 - 2.7 - 4.3	47	45	43	37	29	20	
	700	748	0.124	.155	7 - 10 - 15	33	3.56	353	30.9	38.5	2.1 - 3.2 - 4.7	49	48	47	42	34	25	
	800	855	0.162	.202	8 - 12 - 17	37	4.06	404	40.4	50.3	2.4 - 3.5 - 5.0	51	51	51	46	39	29	
	900	962	0.205	.256	9 - 12 - 18	40	4.57	454	51.1	63.7	2.7 - 3.8 - 5.3	53	53	54	50	43	33	
	1000	1069	0.253	.316	10 - 13 - 18	43	5.08	505	63.1	78.6	3.0 - 4.0 - 5.6	54	55	56	53	47	36	
15" Dia.	200	245	0.012	.014	2 - 3 - 7	-	1.02	116	3.0	3.6	0.6 - 1.0 - 2.0	31	25	16	-	-	-	
	300	368	0.027	.032	3 - 5 - 10	-	1.52	174	6.7	8.1	1.0 - 1.5 - 3.0	37	33	27	17	-	-	
	400	491	0.048	.058	4 - 7 - 13	18	2.03	232	11.9	14.4	1.3 - 2.0 - 3.8	41	38	34	26	16	-	
	500	614	0.074	.090	5 - 8 - 14	24	2.54	290	18.5	22.4	1.6 - 2.5 - 4.3	45	42	40	33	24	16	
	600	736	0.107	.130	7 - 10 - 15	30	3.05	347	26.7	32.3	2.0 - 3.0 - 4.7	47	46	44	39	30	22	
	700	859	0.146	.177	8 - 11 - 17	34	3.56	405	36.4	44.0	2.3 - 3.5 - 5.0	50	49	48	44	34	26	
	800	982	0.191	.231	9 - 13 - 18	38	4.06	463	47.5	57.4	2.6 - 3.8 - 5.4	52	51	52	48	41	31	
	900	1104	0.241	.292	10 - 13 - 19	41	4.57	521	60.1	72.7	3.0 - 4.0 - 5.7	53	54	55	52	45	34	
	1000	1227	0.298	.360	11 - 14 - 20	45	5.08	579	74.2	89.7	3.3 - 4.3 - 6.0	55	56	57	55	49	38	

ARCHITECTURAL & PLAQUE DIFFUSERS

NOTES: Throw values are given for isothermal conditions and terminal velocities of 150, 100, and 50 FPM (0.75, 0.50, and 0.25 m/s). NC values are based on octave band 2 - 7 sound power levels minus a room absorption of 10dB, re 10⁻¹² Watts. Dash in space denotes a NC or dB value of less than 10. Nominal duct is duct width. Data was obtained from tests conducted in accordance with ANSI/ASHRAE Standard 70, ISO Standard 5219, and ISO Standard 3741. See Krueger's selection software for performance data not shown, including octave band data.

PLQ, PLQR Suggested Specification & Configuration

PLQ

The Architectural square panel ceiling diffusers of the sizes and mounting types shown on the plans or outlet schedule shall be the Krueger model PLQ. The PLQ shall have a one piece square face plaque not exceeding 18"x18" for 24"x24" panel sizes and 9"x9" for 12"x12" panel sizes and constructed of 16 gage steel with rounded corners that have a minimum radius of 3/4". Face plaques that have a secondary wrapper are not acceptable. The face plaque shall not extend below the ceiling more than 3/8" and shall be removable from the backpan for access to the optional damper. The diffuser backpan shall be one piece stamped construction of 22 gage steel and have an integrally drawn round neck.

PLQR

The Architectural square panel ceiling diffusers of the sizes and mounting types shown on the plans or outlet schedule shall be the Krueger model PLQR. The PLQR shall have a one piece round face plaque not exceeding 20" diameter for 24"x24" panel sizes and 10" diameter for 12"x12" panel sizes and constructed of 16 gage steel. The face plaque shall not extend below the ceiling more than 3/8" and shall be removable from the backpan for access to the optional damper. Diffusers must discharge in the horizontal plane of the room. The diffuser backpan shall be one piece stamped construction of 22 gage steel and have an integrally drawn round neck.

Optional duct or neck mounted round damper shall be constructed of heavy gage steel. Damper shall be operable from the face of the diffuser.

Optional directional blow tabs shall be constructed of heavy gage steel and offered to provide 1-way, 2-way and 3-way throw patterns.

PERFORMANCE

The manufacturer shall provide published (printed or electronic) performance data for the diffuser. Performance data shall include 2 - 7 octave band sound power levels. The diffuser shall be tested in accordance to the data standards at the time of product introduction or ANSI/ASHRAE Standard 70.

FINISH

The paint finish shall be #44 British White and be an anodic acrylic paint, baked at 315°F for 30 minutes. The paint thickness shall be 0.8 – 1.0 mils, gloss at 60° per ASTM D523-89 of 50 – 85%, pencil hardness per ASTM D3363-92A of HB – H, crosshatch adhesion per ASTM D3359-83 of 4B – 5B, impact per ASTM D2794-93 of direct impact >100 in/lb and reverse impact >80 in/lb, salt spray per ASTM B117-9048 of 96 hours, humidity per ASTM D2247-92 of >500 hours and water soak per ASTM D870-92 of 250 hours.

1. **SERIES: (XXXX)**
 PLQ - Square, Steel Plaque-Style Ceiling Diffuser
 PLQR - Round, Steel Plaque-Style Ceiling Diffuser
2. **NECK: (XX)**
 6"
 7" *
 8"
 10" **
 12" **
 14" **
 15" **
3. **FRAME: (XXX)**
 F22 - Surface Mount
 F23 - Lay-in T-Bar
 F24 - Snap-in T-Bar
 F98 - Narrow-T **
4. **PANEL: (XX)x(XX)**
 12"x12"
 24"x24"
5. **DAMPERS: (XX)**
 00 - No Damper
 03 - PR10
 04 - PRD10
 06 - PR12
 08 - PRN100
6. **ACCESSORIES: (XX)**
 00 - No Accessories
 IB - Insulated Blanket***
 R - Round Straightening Grid
 R6 - Molded Insulation***
7. **FINISH: (XX)**
 01 - Mill
 10 - Alumican
 35 - Black
 44 - British White
 49 - Off White

* Available with 12"x12" panel only.
 ** Available with 24"x24" panel only.
 *** 24" x 24" Panel with 6", 8", 10", or 12" neck dimensions only.

SAMPLE CONFIGURATION: PLQR - 10 - F23 - 24x24 - 00 - 00 - 44