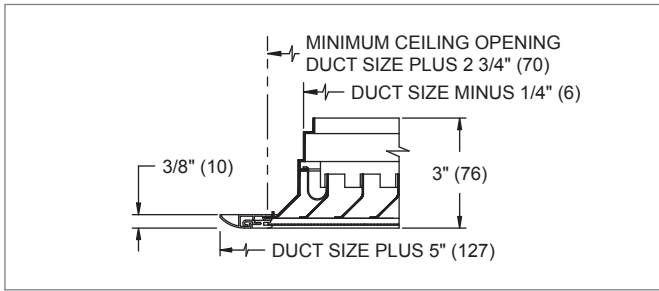
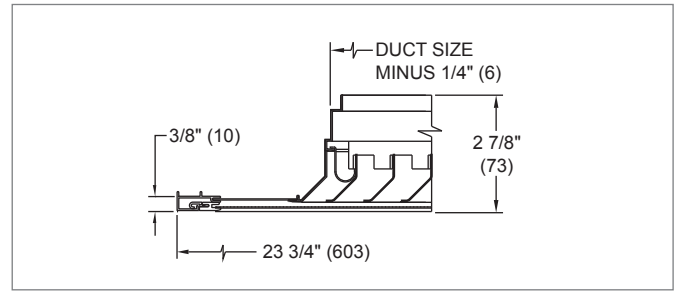
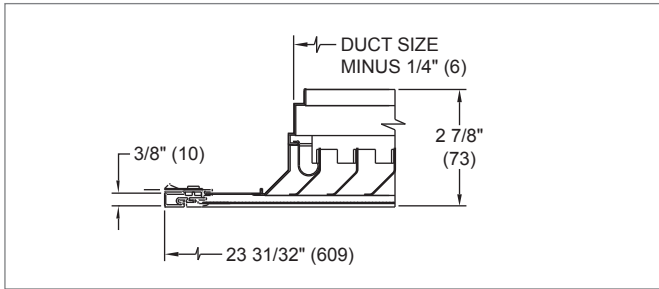
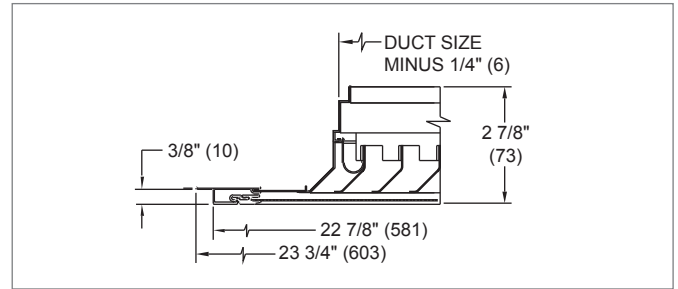
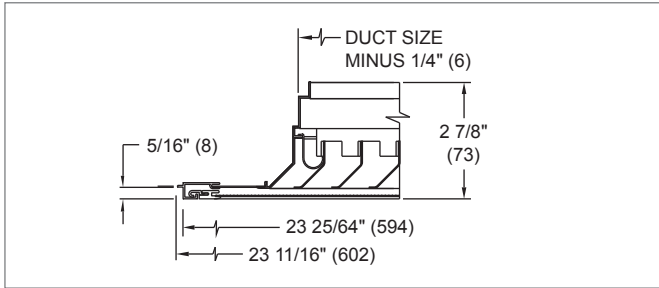
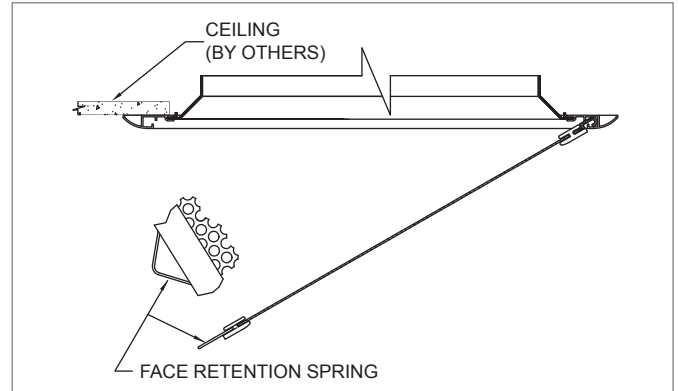
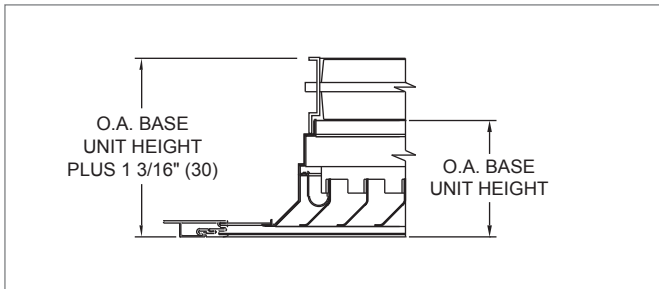
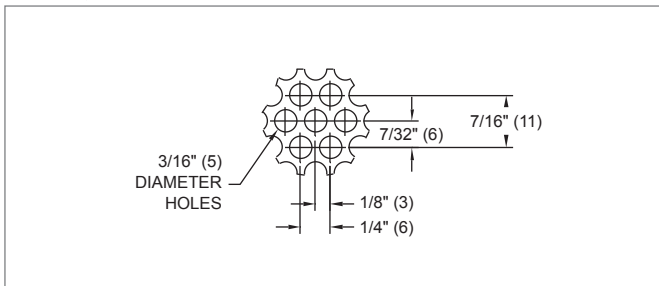

**51240P Frame Styles**
**51240P, FRAME 22, SURFACE MOUNT**

**51240P, FRAME 23, LAY-IN T-BAR**

**51240P, FRAME 29, CAMLOCK**

**51240P, FRAME 30, DROP FACE**

**51240P, FRAME 98, NARROW-T**

**51240P, HINGE DETAIL**

**51240P, OBD DETAIL**

**51240P, PERFORATION DETAIL**

**51240P, AVAILABLE NECK SIZES**

Neck Size	Frame Style				
	Surface Mount	24" x 24" Lay-in Panel			
		F22	F23	F29	F30
6" x 6" (152 x 152)	•	•	•	•	•
8" x 8" (203 x 203)	•	•	•	•	•
10" x 10" (254 x 254)	•	•	•	•	•
12" x 12" (305 x 305)	•	•	•	•	•
14" x 14" (356 x 356)	•	•	•	•	•
16" x 16" (406 x 406)	•	•	•	•	•
18" x 18" (457 x 457)	•	•	•	•	•
20" x 20" (508 x 508)	•				

NOTES: Dimensions in parentheses are mm. Dot indicates available neck sizes.