



SHPCR face view with horizontal setting (above) and vertical setting (right).

**Introduction: SHPCR, 5SHPCR**

The SHPCR/5SHPCR series square diffusers with round necks are available in various sizes and discharge air patterns to meet engineering requirements for capacity and directional throw in addition to a variety of frame styles to meet architectural requirements of today's ceilings. They feature a 1/4" horizontal lip on all sides of the louvered core, resulting in a tight horizontal pattern at the ceiling and a higher discharge velocity at the face. This creates a high induction region just below the face of the diffuser, which improves room air mixing. Additionally, these diffusers have manually adjustable pattern controllers mounted between the core and frame to provide vertical discharge when required. Because they have higher discharge face velocities, this series is an excellent choice for variable air volume systems with above normal temperature differentials. Also, the pattern controllers make them a great choice for use in high ceiling applications with ceiling heights ranging from 10 - 20 feet. At typical flow rates, isothermal throws of 18 - 30 feet make them ideal for mounting centrally in many spaces with high load requirements, while providing high mixing rates in the space.

**MODELS**

- SHPCR - Steel Louvered Diffuser
- 5SHPCR - Aluminum Louvered Diffuser

**FEATURES**

- Round duct connections.
- Adjustable pattern controllers for vertical throw.
- Core is removable from face of diffuser.
- Maintains a horizontal discharge air pattern from maximum to minimum CFM.
- Excellent choice for VAV applications with high loads.
- Excellent choice for high ceiling applications.

**PANEL SIZES**

- 12"x12"
- 24"x24"

**ACCESSORIES**

- Optional straightening grids.
- Optional round damper.

**FINISHES**

- Standard finish is #44 British White.
- Optional finishes available.

**SHPCR, 5SHPCR Dimensional Information**

**SHPCR, 5SHPCR, FACE VIEW**

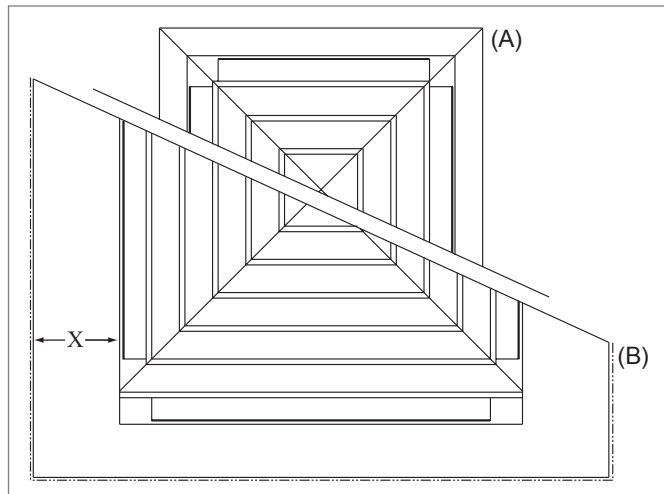

NOTE: Dimension 'X' will vary with neck sizes for Frames 23, 24, 27, and 98.

**SHPCR, 5SHPCR, CROSS SECTION, SURFACE MOUNT (A)**

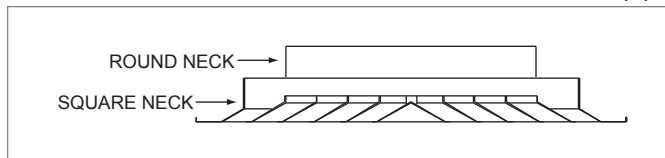

**SHPCR, 5SHPCR, CROSS SECTION, HORIZONTAL**

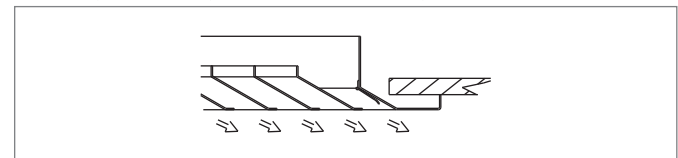

**SHPCR, 5SHPCR, CROSS SECTION, LAY-IN T-BAR (B)**

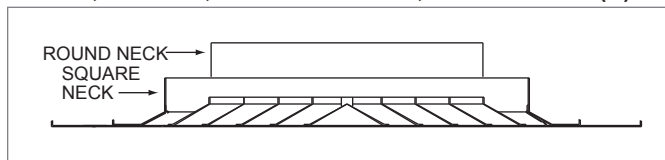

**SHPCR, 5SHPCR, CROSS SECTION, VERTICAL**

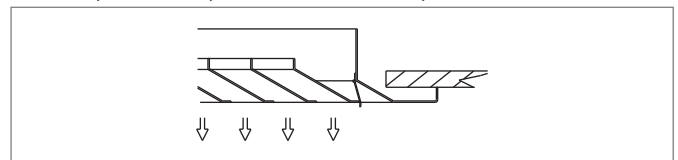

**SHPCR, 5SHPCR Frame Styles**

**SHPCR, 5SHPCR, FRAME 21, SURFACE MOUNT, BEVELED**

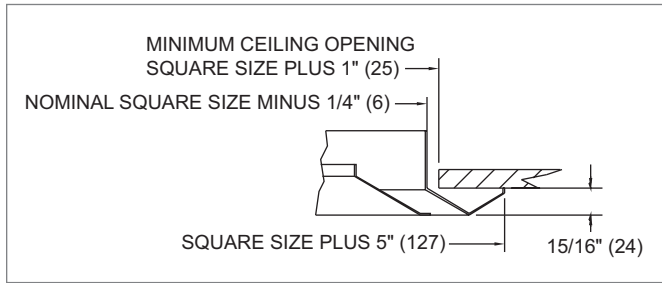

**SHPCR, 5SHPCR, FRAME 22, SURFACE MOUNT, FLAT**

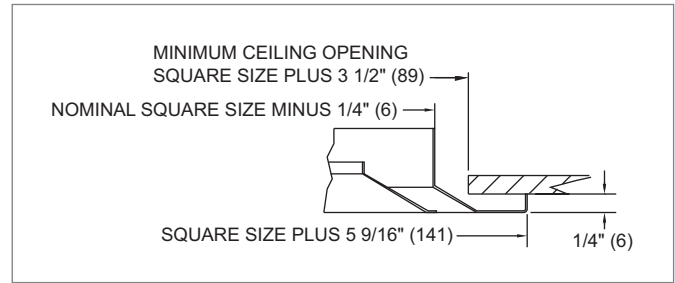

**SHPCR, 5SHPCR, FRAME 23, LAY-IN T-BAR**

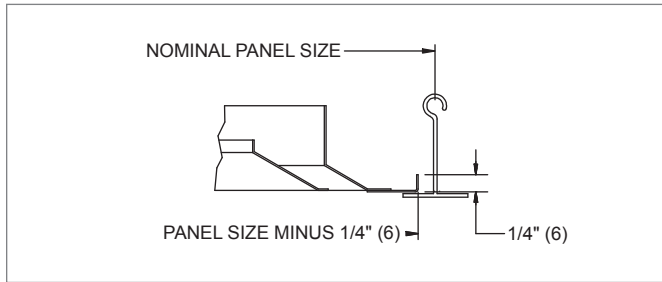

**SHPCR, 5SHPCR, FRAME 24, SNAP-IN T-BAR**

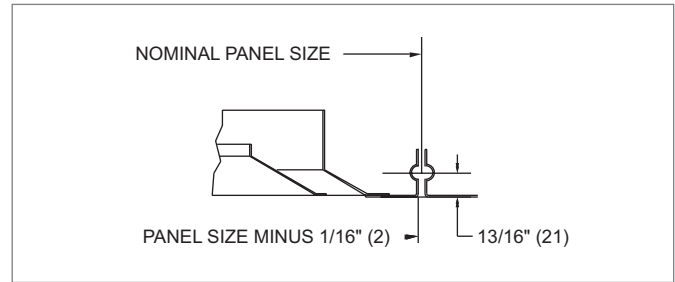

**SHPCR, 5SHPCR, FRAME 27, SPLINE**

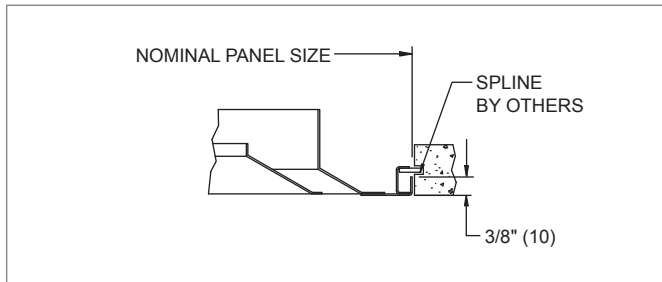

**SHPCR, 5SHPCR, FRAME 98, NARROW-T**

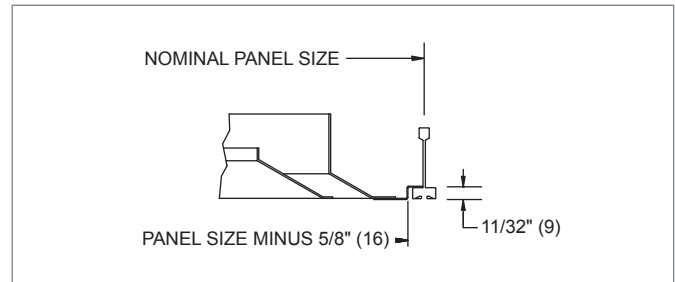

**SHPCR, 5SHPCR, CROSS SECTION, OVERALL HEIGHT**

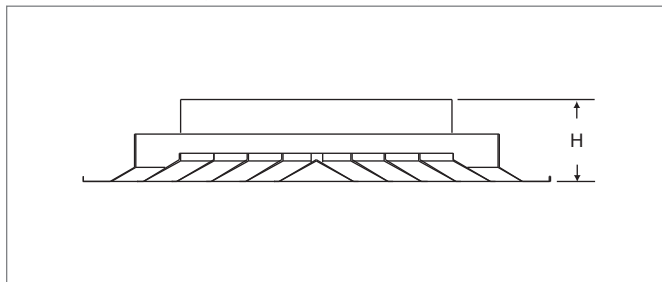

See page B1-38, "Snap-in Core Instructions" for removal of the core.

**SHPCR, 5SHPCR, AVAILABLE NECK SIZES**

Round Inlet	H	Panel Size	Nominal Square
6	3 1/8" (79)	12"x12" (305x305)	6" (152)
6	3 1/8" (79)	24"x24" (610x610)	6" (152)
			9" (229)
			12" (305)
			15" (381)
8	3 3/8" (86)	24"x24" (610x610)	18" (457)
			9" (229)
			12" (305)
			15" (381)
10	3 3/8" (86)	24"x24" (610x610)	18" (457)
			12" (305)
			15" (381)
			18" (457)
12	3 3/8" (86)	24"x24" (610x610)	18" (457)
			12" (305)
			15" (381)
			18" (457)
14	3 3/8" (86)	24"x24" (610x610)	15" (381)
			18" (457)
16	3 3/8" (86)	24"x24" (610x610)	18" (457)

NOTE: Dimensions in parentheses are mm.