

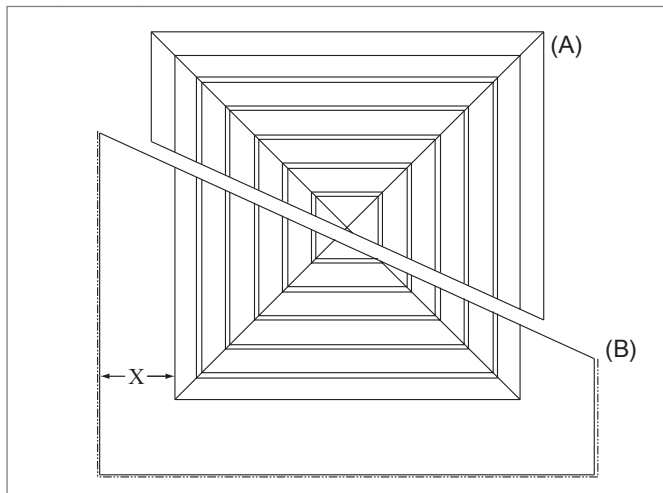

SHR

**SHR, 5SHR Dimensional Information**

**SHR, 5SHR, FACE VIEW**



NOTE: Dimension 'X' will vary with neck sizes for Frames 23, 24, 27, and 98.

**SHR, 5SHR, CROSS SECTION, SURFACE MOUNT (A)**

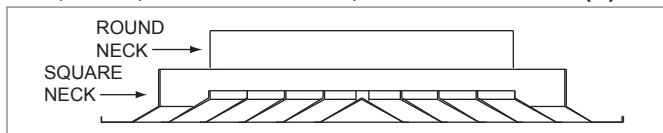

**SHR, 5SHR, CROSS SECTION, LAY-IN T-BAR (B)**

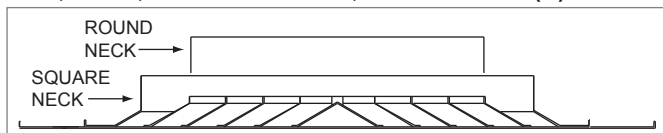

**Introduction: SHR, 5SHR**

The SHR/5SHR series square diffusers with round necks are available in various sizes and discharge air patterns to meet engineering requirements for capacity and directional throw in addition to a variety of frame styles to meet architectural requirements of today's ceilings. They feature a 1/4" horizontal lip on all sides of the louvered core, resulting in a tight horizontal pattern at the ceiling and a higher discharge velocity at the face. This creates a high induction region just below the face of the diffuser, which improves room air mixing. Because this series has higher discharge face velocities, they are an excellent choice for variable air volume systems with above normal temperature differentials. At typical flow rates, isothermal throws of 18 - 30 feet make the SHR/5SHR ideal for mounting centrally in many spaces with high load requirements while providing high mixing rates in the space.

**MODELS**

- SHR - Steel Louvered Diffuser
- 5SHR - Aluminum Louvered Diffuser

**FEATURES**

- Core is removable from face of diffuser.
- Round duct connections.
- Maintains a horizontal discharge air pattern from maximum to minimum CFM.
- Excellent choice for VAV applications with high loads.

**PANEL SIZES**

- 12"x12"
- 24"x24"

**ACCESSORIES**

- Optional straightening grid.
- Optional round damper.

**FINISHES**

- Standard finish is #44 British White.
- Optional finishes available.

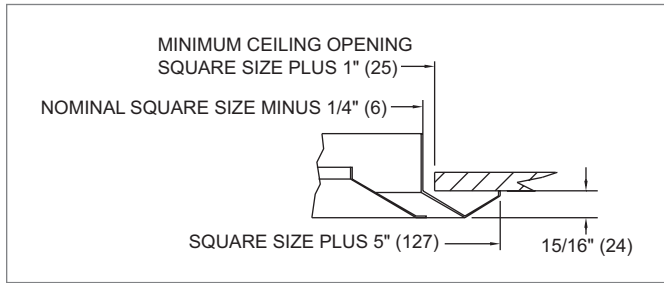
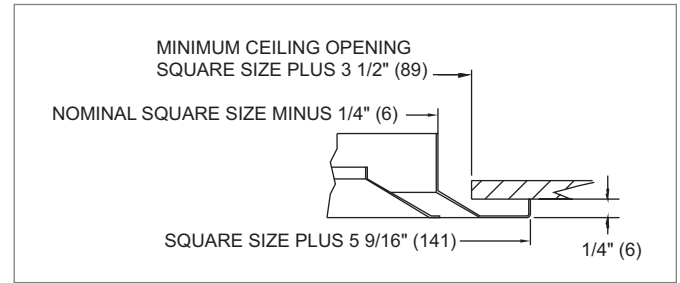
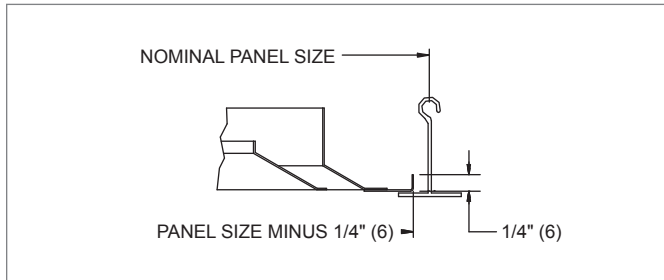
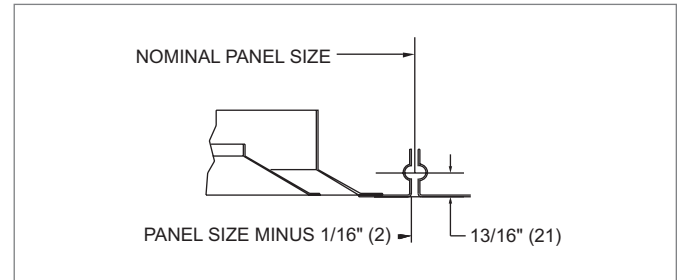
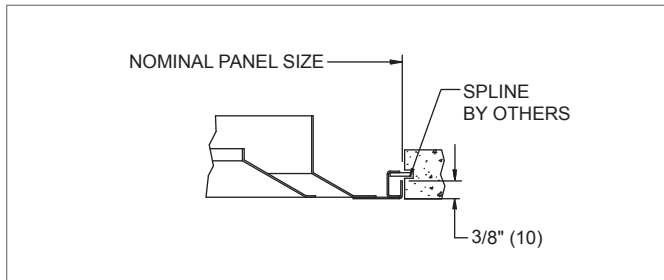
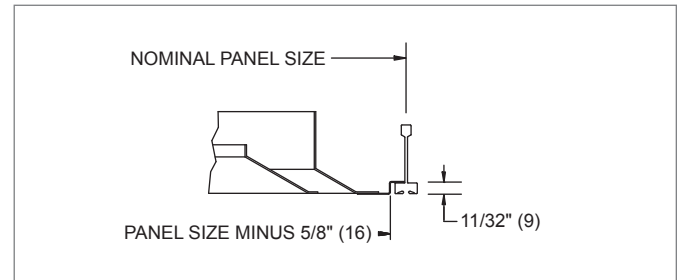
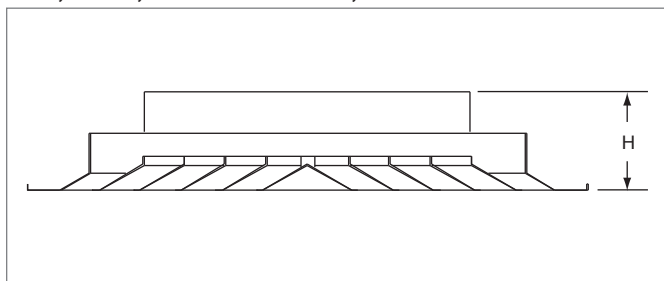
**SHR, 5SHR Frame Styles**
**SHR, 5SHR, FRAME 21, SURFACE MOUNT, BEVELED**

**SHR, 5SHR, FRAME 22, SURFACE MOUNT, FLAT**

**SHR, 5SHR, FRAME 23, LAY-IN T-BAR**

**SHR, 5SHR, FRAME 24, SNAP-IN T-BAR**

**SHR, 5SHR, FRAME 27, SPLINE**

**SHR, 5SHR, FRAME 98, NARROW-T**

**SHR, 5SHR, CROSS SECTION, OVERALL HEIGHT**

NOTES: Dimensions in parentheses are mm. Core removal is the same as the SH series of diffusers. Reference page B1-38 for details.

\* Available in 4-way discharge air pattern only.

**SHR, 5SHR, AVAILABLE NECK SIZES**

Round Inlet	H	Panel Size	Nominal Square
6	3 1/8" (79)	12"x12" (305x305)	6" (152)
			9" (229)*
8	3 3/8" (86)	12"x12" (305x305)	9" (229)*
6	3 1/8" (79)	24"x24" (610x610)	6" (152)
			9" (229)
			12" (305)
			15" (381)
8	3 3/8" (86)	24"x24" (610x610)	18" (457)
			9" (229)
			12" (305)
			15" (381)
10	3 3/8" (86)	24"x24" (610x610)	18" (457)
			12" (305)
			15" (381)
12	3 3/8" (86)	24"x24" (610x610)	18" (457)
			12" (305)
			15" (381)
14	3 3/8" (86)	24"x24" (610x610)	18" (457)
			15" (381)
16	3 3/8" (86)	24"x24" (610x610)	18" (457)