



AYK 580 Air-Modulator

ENGINEERING GUIDE



1 - 75HP / (4.6 to 273 Amps)	208 - 240VAC
1.5 - 150HP / (2.1 to 180 Amps)	380 - 480VAC
2 - 125HP / (2.7 to 125 Amps)	515 - 600VAC



Table of Contents

INTRODUCTION	5
NOMENCLATURE.....	6
PRODUCT DESCRIPTION	7
APPLICATION	13
DIMENSIONS	17
PERFORMANCE DATA.....	66
PERFORMANCE DATA (CONTINUED)	68
SPECIFICATIONS.....	76
APPENDIX C	140
GLOSSARY.....	155

LIST OF FIGURES

FIGURE 1 - "CF" Package: Drive with fused disconnect input, mechanical 2 contactor bypass, VFD fast acting fused isolation service disconnect, Nema 2 infloor installation	12
FIGURE 2 - Fan Curves With Inlet Vane Control.....	14
FIGURE 4 - Air-Mod Part Load Performance	14
FIGURE 3 - Fan Curves With Variable Speed Control	14
FIGURE 5 - Typical VAV System	14
FIGURE 6 - Air Volume Control Of The Centrifugal Fan.....	15
FIGURE 7 - Constant Volume System - Retrofit.....	15
FIGURE 8 - Direct Expansion VAV System	15
FIGURE 9 - Fan Control	16
FIGURE 10 - R1 Frame Dimensions	19
FIGURE 11 - R2 Frame Dimensions	20
FIGURE 12 - R3 Frame Dimensions	21
FIGURE 13 - R4 Frame Dimensions	22
FIGURE 14 - R5 Frame Dimensions	23
FIGURE 15 - R6 Frame Dimensions	24
FIGURE 16 - R7 Frame Dimensions	25
FIGURE 17 - R8 Frame Dimensions	26

FIGURE 18 - R9 Frame Dimensions	27
FIGURE 19 - NI Box 1 Disconnect Only	28
FIGURE 20 - NI Box 2 Disconnect Only	29
FIGURE 21 - NI Box 3 Disconnect Only	30
FIGURE 22 - NI Box 4 Disconnect Only	31
FIGURE 23 - NI Box 5 Disconnect Only	32
FIGURE 24 - NI Box 6 Disconnect Only	33
FIGURE 25 - NI Bypass Box 1	34
FIGURE 26 - NI Bypass Box 2	36
FIGURE 27 - NI Bypass Box 3	38
FIGURE 28 - NI Bypass Box 4	40
FIGURE 29 - NI Bypass Box 5	42
FIGURE 30 - NI Bypass Box 6	44
FIGURE 31 - 3R Nonbypass Box 1	48
FIGURE 32 - 3R Nonbypass Box 2	49
FIGURE 33 - 3R Nonbypass Box 3	50
FIGURE 34 - 3R Nonbypass Box 4	51
FIGURE 35 - 3R Nonbypass Box 5	52
FIGURE 36 - 3R Nonbypass Box 6	53
FIGURE 37 - 3R Bypass Box 1	54
FIGURE 38 - 3R Bypass Box 2	56
FIGURE 39 - 3R Bypass Box 3	58
FIGURE 40 - 3R Bypass Box 4	60
FIGURE 41 - 3R Bypass Box 5	62
FIGURE 42 - 3R Bypass Box 5	64
FIGURE 43 - AYK580 Wall Mount Drive	75
FIGURE 44 - Standard Hand-Off-Auto Panel Control Panel Layout	81
FIGURE 45 - Installing Unit Vertically Alone	83
FIGURE 46 - Installing Unit Vertically Side By Side	83
FIGURE 47 - Horizontal Side By Side Intstallation	84
FIGURE 48 - Electrical Power System Types	86
FIGURE 49 - Non-bypass with fused disconnect (PF) Circuit diagram	93
FIGURE 50 - Classic Bypass with Fused Disconnect (CF) Diagram.....	93
FIGURE 51 - Default Control Connections for the HVAC Default.....	101
FIGURE 52 - External Control Connection Terminals, Frames R1...R5	102
FIGURE 53 - Default Control Connections for R6...R9.....	103
FIGURE 54 - External Control Connection Terminals, Frames R6...R9	104
FIGURE 55 - Wiring Connection for R0...R3 ACS580-01, ACH580-01, ACQ580-01	105
FIGURE 56 - Power Connections and Control Interfaces	106
FIGURE 57 - N1-N3R Fused Disc Non Bypass.....	108

Table of Contents (continued)

Introduction

AIR-MODULATOR

Johnson Controls has led the HVAC industry in variable speed drive (VSD) technology since 1979 with the introduction of the Turbo-Modulator – the variable speed drive specifically designed for centrifugal chiller application. The Johnson Controls involvement in applying electronics to HVAC technology exceeds that of any other company either in the HVAC industry or the electronics industry. Since 1983, when the Air-Modulator was introduced, Johnson Controls has successfully applied thousands of these drives to fans, pumps, and cooling towers providing exceptional energy savings, high-reliability, and performance.

This Air-Modulator guide is intended as a reference to application and installation information for the HVAC design engineer. The content of this guide provides general theory of operation, application information, key design parameters, and complete specifications.

Why Variable Speed?

Centrifugal fans and pumps are commonly used in HVAC equipment. Because of their centrifugal design, any reduction in the speed at which the fan or pump operates causes a cubic reduction in the horsepower the motor requires. This is represented by the following equation:

EXAMPLE:	
$\frac{(RPM_2)^3}{(RPM_1)^3} = \frac{(HP_2)}{(HP_1)}$	SPEED % HP %
	100% 100%
	90% 73%
	80% 51%
	70% 34%
	60% 22%
	50% 13%
	40% 7%
	30% 3%

This shows that a 10% reduction in the RPM of the fan or pump results in a 27% reduction in horsepower required. Therefore, a means by which the RPM or speed of the fan or pump could be reduced would produce significant energy savings. The Air-Modulator provides such a means by varying the speed of the fan or pump motor.

What is a Variable Speed Drive?

A variable speed drive is an electronic device which changes the speed of a motor by changing the frequency and voltage fed to the motor. An AC motor runs at a speed proportional to the frequency applied, as described in the following formula:

$$\text{Synchronous motor speed} = \frac{120 \times \text{frequency}}{\text{Number of motor poles}}$$

The speed is dependent on the frequency; a change in frequency will change the motor speed. The AC motor, however, must also have the voltage vary in the same proportion as the frequency to maintain full torque capabilities throughout the speed range. Therefore, a variable speed drive must change both the frequency and the voltage of the power fed to the motor to vary speed while maintaining torque for the required load.

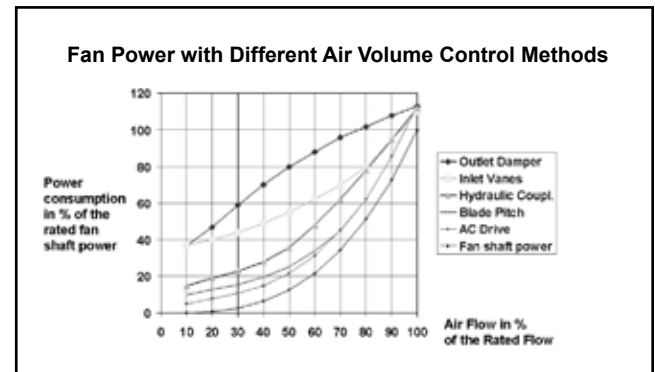

Nomenclature

AYK580 - 01 - 015A - 2 + XXXX

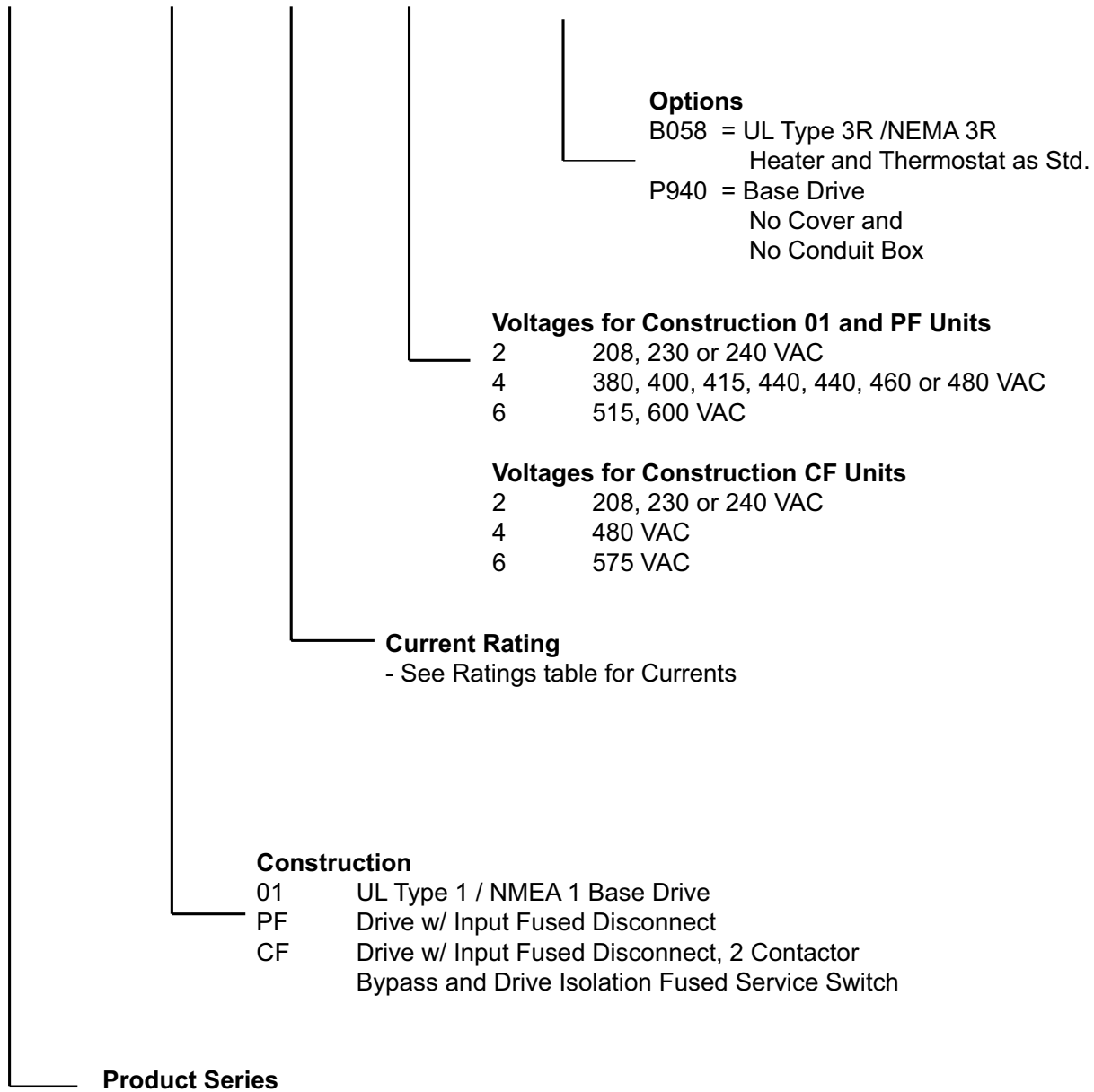

Product Description

AYK580

The AYK580 is a Johnson Controls Variable Frequency LV AC Drive for the control of three phase AC motors. Johnson Controls applies this product regularly on Johnson Controls Air Handlers. These AC Drives are manufactured by ABB for Johnson Controls. This affords users with the opportunity to have one feature rich AC drive applied throughout a facility for HVAC requirements, with minimal familiarization training, parts and service, allowing Johnson Controls to provide for your total service needs.

The AYK580 is an adjustable frequency AC drive designed specifically for the HVAC market that achieves the ultimate in flexible motor control performance. Offering two modes of motor control: Scalar (V/Hz) and Sensorless Vector as well as PM Motor control. The AYK580 performs accurate speed control of any standard squirrel cage motor.

With drives ranging from 1 to 150 HP, the AYK580 series features an 'intuitively obvious' multi-lingual, full graphic display panel that also provides an assistant to aid users in start-up. The control panel can be mounted on the cover of the drive, or remotely, and can upload, store, and download parameters.

The AYK580 comes equipped with an extensive library of pre-programmed HVAC application macros that, at the touch of a button, allow rapid configuration of inputs, outputs, and parameters for specific HVAC applications to maximize convenience and minimize start-up time.

The AYK580 can be used for the simplest to the most demanding HVAC applications. Two integral option slots can be configured with additional relay outputs, 24 V AUX power, as well as a host of different communication bus adapters.

The AYK580 has a 110% short term overload rating for one minute out of ten and is capable of 130% short-term overload rating for 2 seconds out of each minute.

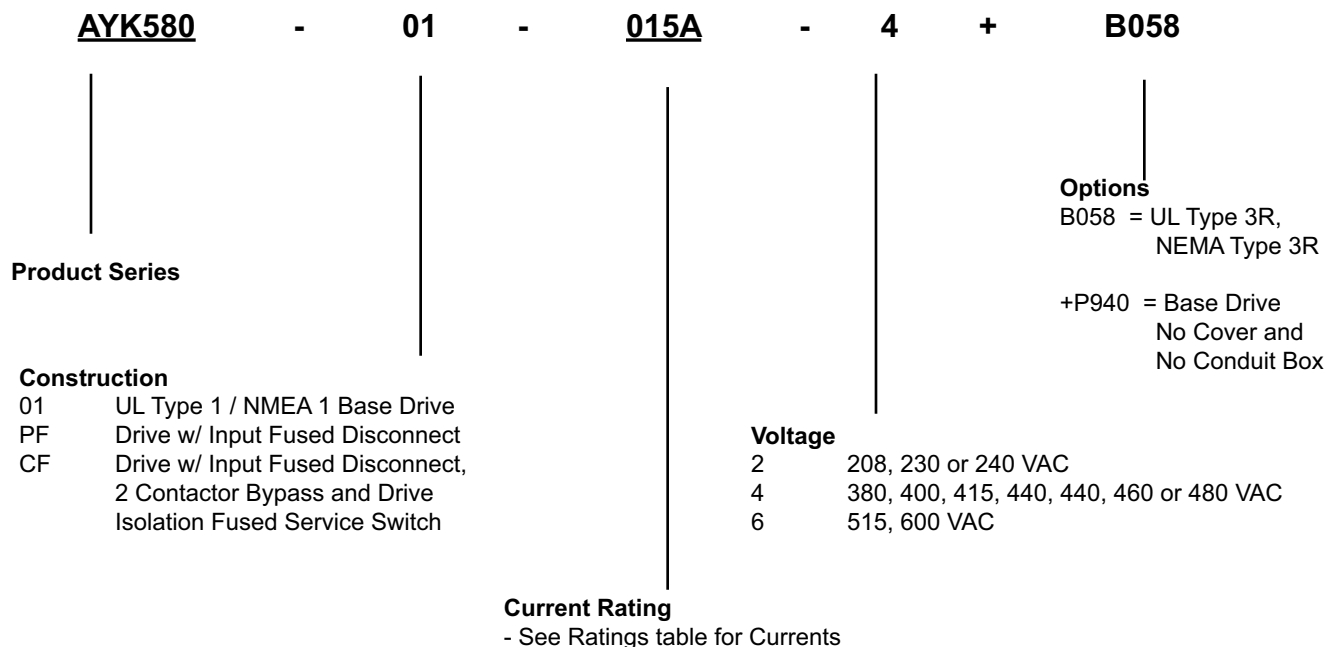

Product Description (continued)

AYK580 Smart Code

Johnson Controls is introducing a smart type code for the AYK580 drive. The purpose of the code is to provide a unique alpha-numeric code that will be used for ordering or post sale support to define the specifics

of enclosure type, construction, voltage, current, and installed options for ease of continued support. This type code represents the basic drive product. To add options to these products, simply add a + at the end of the type code followed by the catalog code shown for that option. Please refer to the smart code table for each configuration showing the allowed options for each configuration.

Example: AYK580-CF-046A-2 plus a B058,

The type code that should be indicated on the order would be:

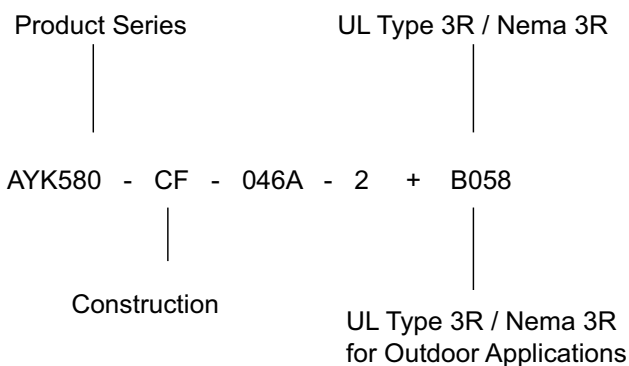

AYK580-01 (Base Drives)

The AYK580-01 Base Drive is available from 1 to 100 HP (4.6 to 273 Amps) at 208/230/240V, 1 to 350 HP / (2.1 to 414 Amps) at 380/400/415/440/460/480V, and 2 to 250 HP (2.7 to 271 Amps) at 600V input voltages. The AYK580-01 Base Drive has nine frame sizes (R1 to R9). They also include as standard an advanced control panel for user interface, parameter adjustments and drive operations. They are mounted on the front of the drive and can be remote mounted if required.

Wall mounted AYK58001

All AYK580-01 Base Drives are able to be wall mounted and come with a Conduit/Junction Box as standard to meet UL Type 1 (NEMA 1) applications. The front section of the wall mounted AYK580-01 contains the electronics, power and control wire terminals. The rear section forms a cooling channel. The two section construction allows the unit to be installed protruding

through a wall, or through the rear wall of a customer supplied enclosure using additional hardware (R1 to R9), placing the rear section in a cooling air duct to minimize the heat inside the cabinet. In standard installations, the drive is mounted directly onto a wall and uses the provided conduit box (required for NEMA 1 installation). The Conduit Box and it's required hardware is included as standard with all 01 Base Drives. If not needed please discard at your discretion. Conduit openings (knock-outs) are provided for bottom and side conduit entry. For mounting inside a customer supplied cabinet, the conduit box may be removed.

AYK580-PF (AYK580 Drive with Fast Acting Fused Input Disconnect)

The AYK580 Drive with Fused Input Disconnect as Standard is an AYK580- 01 base drive packaged with a fused (PF). The AYK580-PF is available in a wall mounted enclosure from 1 to 75 HP (4.6 to 211 Amps) at 208/230/240V, 1 to 150 HP (2.1 to 180 Amps) at 380/400/ 415/440/460/480V and 2 to 125 HP (2.7 to 125 Amps) at 600 Volt. The AYK580 Drive Pack comes in a standard UL Type 1 (NEMA 1) galvanized Non Rust steel enclosure and <+B058> UL Type 3R (Nema 3R).

The AYK580 Drive Pack has the NEMA 1 AYK580-01 base drive mounted on the top of a back panel allowing access to the drive control panel for user interface. The AYK580 Drive Pack provides an enclosed fused disconnect with door-mounted operator (padlockable in the OFF position), electronic motor overload protection (provided from the base drive), and provisions for external control connections. Conduit openings (knock-outs) are provided for bottom and rear conduit entry.

Complete, pre-engineered packages reduce time, effort and the cost of installing the JCI configured packages.

AYK580-CF (AYK580 Drive w/ Fused Disconnect Input, 2 Contactor Classic Bypass, Fast Acting Fused Drive Isolation Service Switch)

The AYK580 Drive with classic bypass is an AYK580-01 base drive packaged with a fused (CF) input main disconnect switch, a two contactor bypass and a fast acting drive isolation service switch. This configuration allows the motor to be run at full voltage in the event the drive is shut down for service. The Fast Acting Fused Drive Isolation Service Switch serves two purposes: It incorporates Fast Acting Drive Input Fusing which protects the bypass circuit if the drive was to ever fail as well as a switch to isolate the Drive from the Bypass and Power Source for service. These pre-engineered packages reduce time, effort, and the cost of installation.

The bypass function is configured entirely of standard industrial control components. It includes two Mechanically interlocked contactors, an Electronic motor overload relay, a control power transformer with primary and secondary fusing, and cover mounted Hand-Off-Auto switch and Drive-Off-Bypass selector switch.

Bypass is accomplished by means of the two contactors. One is the bypass contactor used to connect the motor directly to the power line. The other is the drive output contactor that disconnects the motor from the drive output when operating in the bypass mode. This prevents the "back feeding" that would occur if line voltage were applied to the drive output terminals. The drive output contactor and the bypass contactor are mechanically interlocked to prevent simultaneous operation. Motor overload protection in the bypass mode is provided by a Class 10, 20 or 30 electronic motor overload relay. AYK580 Drive W/ Bypass Packages include a J Type fused (CF) input disconnect switch with a door mounted external operating handle that is interlocked with the enclosure door and lockable in the OFF position with up to three padlocks. The multi-lingual, alphanumeric drive control panel is mounted on the enclosure door. As Standard a Fast Acting Fused Drive Service Switch isolates the drive from the power source for service and provides superior functionality to a three contactor arrangement.

Drive W/ Bypass Packages are available in UL TYPE 1 (NEMA 1) Non Rust galvanized steel enclosures and UL Type 3R (Nema 3R) through 75 HP (211 Amps) at 208/230V, 150HP (180 Amps) at 460 Volt and 125 HP (125 Amps) at 575 Volt

Application considerations

Always follow and abide by proper Lock-Out/Tag-Out procedures when working with electrical equipment.

Because of the variety of uses for the AYK580, those responsible for the application and control of these drives must satisfy themselves that all necessary steps have been taken to insure that they meet all performance and safety requirements regarding national and local laws, regulations, codes and standards. Unless otherwise noted, AYK580 products found in this Engineering Guide are designed to meet UL Type (UL & cUL Environmental Ratings) and NEMA Type (National Electrical Manufacturers Association) standards.

AYK580-01 Base Drives are Approved for installation in a CE first environment. Restricted distribution is also provided with the AYK580-01 Base Drives at 480V, which carry the CE mark. The AYK580 Drives with input disconnect or classic bypass are supplied for UL/cUL and are not provided with a CE mark. These listings are based on standard product and any exceptions to this will be noted in the appropriate section.

Branch Circuit Protection (The AYK580-01 Base Drive)

The AYK580-01 Base Drive does not include a Disconnect Device. A means to Disconnect and Put power must be installed between the AC Power Source and the AYK580-01 Base Drive. This branch circuit protection must:

- Be sized to conform to applicable safety regulations, including, but not limited to, both National and local electrical codes.
- Be locked in the open position during installation and maintenance work.

The disconnect device must not be used to control the motor. Instead use the control panel, or commands to the I/O terminals for motor control. Cycling the disconnect device cycles power to the drive's DC capacitors. These capacitors have a maximum limit of 5 cycles in ten minutes.

Product Description (continued)

Fuses

See the AYK580-01 user's manual for fuse recommendations for short circuit protection on the drive's input power. These recommendations are not requirements if branch circuit protection is otherwise provided per NEC. UL508A manufacturers are not required to use the recommended fuses for the purpose of UL listing a panel that includes the AYK580.

Branch circuit protection (AYK580- PF/CF Drive Packages)

The Drive with fast acting input fused disconnect (AYK580-PF) or Drive with classic bypass, J Type Fused Main Power Input Disconnect and fast acting drive fused isolation service switch (AYK580-CF) is supplied with a means to disconnect input power sized per UL508A, and the disconnect is lockable in the open position. The Main Fused Disconnects in both packages provide short circuit for the drive panel. AYK550-CD and sized to conform to applicable safety regulations, including, but not limited to, both National and local electrical codes.

Selecting the Correct Drive Capacity

All AYK550 drives are current rated devices. The HP ratings provided are for reference only and are based on typical 4-pole motors at nominal voltages (NEC Table 430-150). If full motor torque is required, ensure the drive has a continuous current rating equal to, or greater than, the full load amp rating of the motor.

JOHNSON CONTROLS PACKAGE CONFIGURATIONS

The following AYK580 JCI Drive configurations are available as standard product offerings:



Base Drive

"01" Configuration

- AYK580 VFD UL Type 1 / NEMA 1 / conduit box supplied as standard
- AYK580 HVAC advanced control panel supplied as standard
- 100K SCCR at 480 V w/ fast acting drive input fusing



Base Drive with

Fused Disconnect

"PF" Configuration

- AYK580 VFD "01" Base Drive w/ fast acting drive input fusing belly box
- Available as standard:
 - UL Type 1 / Nema 1 indoor
 - UL Type 3R / Nema 3R outdoor
- Fused main disconnect with pad lockable handle
- 100K SCCR at 480 V



Base Drive with Bypass, VFD Isolation Service Switch, Main Fused Disconnect

"CF" Configuration



- AYK580 VFD available as standard UL Type 1 / Nema 1 indoor UL Type 3R / Nema 3R outdoor Supplied as standard Special note: Heater and thermostat included on all 3R units.
- Main J Type fused disconnect with pad lockable handle in the open position
- VFD input fast acting fused service disconnect
- Control power transformer
- Classic 2 contactor (wide range coil) mechanical bypass
- Class 10, 20, or 30 electronic overload relay for bypass circuit
- VFD/OFF/BYPASS (3 position) selector switch
- HAND/OFF/AUTO (3 position) selector switch for operation in bypass only. HOA in VFD mode through VFD control panel



Product Description (continued)



FIGURE 1 - "CF" PACKAGE: DRIVE WITH FUSED DISCONNECT INPUT, MECHANICAL 2 CONTACTOR BYPASS, VFD FAST ACTING FUSED ISOLATION SERVICE DISCONNECT, NEMA 2 INFOOR INSTALLATION

Application

GENERAL APPLICATION CONSIDERATIONS

Horsepower/Amerpage Range

The Johnson Controls AYK580 is a complete product line covering the nominal horsepower sizes from 1 HP to 100 HP (4.6 Amps to 273 Amps) for 208 V to 240V/3-Phase, 1 HP to 150 HP (2.1 Amps to 180 Amps) for 380V to 480V/3-Phase, and 2 HP to 125 HP (2.7 Amps to 125 Amps) for 600V/3-Phase. The critical sizing parameter is the output current rating of the drive. The nameplate FLA rating of the motors must not exceed the output current rating of the drive at 208, 230, 380, 480 or 575 VAC. Horsepower Ratings are for reference ONLY.

The AYK580 Drives are designed with sufficient current capacity to be applied to high efficiency motors. The current capacity complies with the industry's Energy Policy Act (EPA) motor full load amp ratings. VFD FLA output ratings meet or exceed Table 430-250 of the National Electric Code® 1993.

Power Supply

The base drive (AYK580-01) is designed for nominal 208 V to 2240 V (+10%...-15%), 48-63 Hz, 380 V to 480 V (+10%...-15%), 48-63 Hz input power, or (+10%/-15%), 600 V. For other power supply systems, a step transformer must be used. The minimum required kVA rating of the transformer must be calculated as follows:

Transformer kVA =

$$\frac{1.732 \times \text{Line to Line Voltage} \times \text{VFD Input Amps}}{1000}$$

Power factor correction capacitors are not required as the Air-Modulator maintains a .98 power factor at nominal load.

Example:

399.05 kVA =

$$\frac{1.732 \times 480 \times 480}{1000}$$

In this example the drive is supplied with 480 V AC and rated for 480 amps. Based upon the calculation a 400 KVA isolation transformer would be required for the example above. When requesting information from the transformer vendor let them know that 100% of the transformer load will be a variable speed drive.

Location

These drives are designed for indoor location, in a NEMA-1 classification area, having 5°F to 104°F (-15°C - 40°C) ambient temperature limits. The relative humidity of the area should be between 5% to 95% non-condensing.

Sufficient clearance (as noted in the dimensional section) to permit normal servicing and maintenance should be provided around the entire unit.

Power Wiring

These drives are equipped with power lugs for easy connection of power wiring. Maximum wiring size for each Air-Modulator is listed in the power and control wiring drawing, Form 100.04-PA1.2. A single point ground connection is provided in the drive package. Power wiring should be sized and installed in accordance with the National Electrical Code (NEC). Copper wire is required for all power wiring connections to all of the AYK580-01 base drives and packages.



DO NOT USE ALUMINIUM WIRE



Terminals Are Not Rated For Use With Aluminium Wire

For wiring and fuse sizing purposes, follow the guidelines for Rated Input Current and Max Prefuse Amps listed in Performance Data.

The AYK580-01 base drives are designed with electronic I²t U.L. listed overload protection which limits the current to 100% of the motor rated current eliminating the need for thermal overload relays. This is in compliance with section 430-250 of the NEC.

Control Wiring / Interface

Johnson Controls provides as standard on Air-Modulators a single point control interface which accepts standard control signals (4-20mA, 0-5VDC, 0-10VDC) mounted in the unit. Also available for factory mounting is a pneumatic control interface which accepts a standard 3-15 PSIG control signal.

NOTE:



For 380V, 50Hz applications, size VFD for FLA that meet or exceed motor FLA.



Application (continued)

FAN APPLICATIONS

Theory of Operation

Variable Air-Volume (VAV) systems have long been accepted as the energy efficient air distribution method. Johnson Controls and other HVAC suppliers have, traditionally, offered Variable Inlet Vanes (VIV) on air handling units to provide this variable air volume capability. VIVs unload the fan by adding a pre-swirl to the air as it enters the fan in such a way as to provide a reduction in head pressure across the fan and a decrease in air flow rate. This causes a change in the operating point of the fan on the system curve (Fig. 2) and a subsequent reduction in the horsepower drawn by the fan motor.

Alternatively, the Air-Modulator unloads the fan by slowing it down. This shifts the RPM curve on which the fan operates. By reducing the RPM curve, the operating point now requires significantly less brake horsepower than a system using VIVs. This is shown in Fig. 3. The part load performance comparison is shown in Fig. 4.

Application

Variable speed drives can be applied to forward-curved, airfoil or backward-inclined centrifugal fans. When retrofitting the Air-Modulator to a fan with existing VIVs, the VIVs should either be removed or locked into the wide open position. Leaving the vanes on the

fan will require the fan to use more power than if they were removed. The power penalty can range from 5% to 25% of FLA depending on fan size and velocity of air across the vanes. The smaller the fan, the higher the penalty.

Sequence of Operation

The typical variable speed air system is depicted in Fig. 5. It consists of an air handling unit being controlled by an Air-Modulator, duct work, and standard temperature controls. Under full load conditions, the fan is running at full speed and the discharge dampers are fully open, allowing the maximum amount of cooling into the space. As the cooling diminishes, the temperature controls send a signal to the dampers to close; this increases the static pressure in the duct work. A static pressure sensor in the duct work sends a signal through a receiver/controller to the Air-Modulator, telling it to slow down the motor proportionally.

The reduced motor and fan speed matches the air flow to the space temperature. As the space temperature rises, the dampers open lowering the duct static pressure. A reduction in static pressure will cause the Air-Modulator to increase the speed of the motor, again matching the air flow to the space temperature.

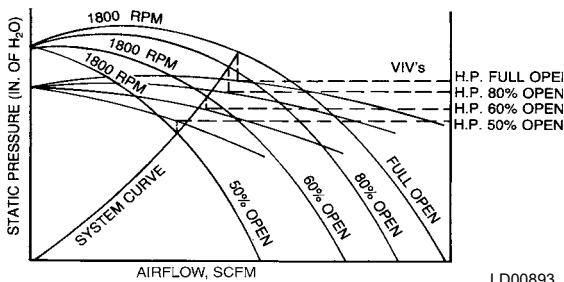

FIGURE 2 - FAN CURVES WITH INLET VANE CONTROL

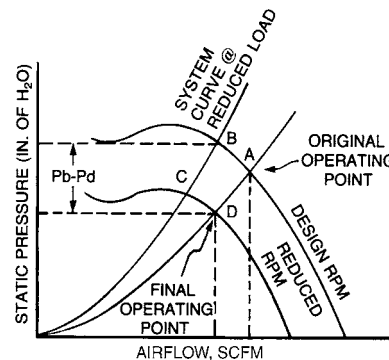

FIGURE 3 - FAN CURVES WITH VARIABLE SPEED CONTROL

Fan Power with Different Air Volume Control Methods

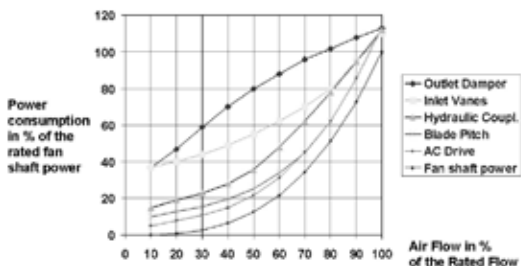

FIGURE 4 - AIR-MOD PART LOAD PERFORMANCE

VAV Variable Speed Fans - Control

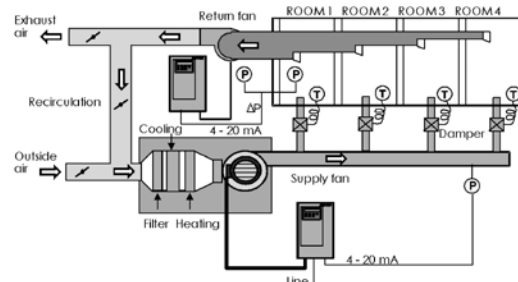

FIGURE 5 - TYPICAL VAV SYSTEM

RETROFIT FAN APPLICATIONS

Mechanical Volume Control Retrofit

The Air-Modulator can be easily retrofitted into existing systems. The existing starter controls can be integrated into the Air-Modulator as well as the existing transducer can be fed into the Air-Mod's PI controller for set-point control. The existing volume controls (ie: inlet guide vane, discharge damper, etc) can be removed or locked in the full open position. See Fig 6.

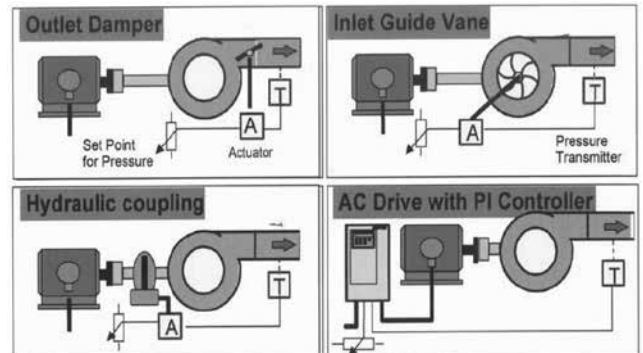

FIGURE 6 - AIR VOLUME CONTROL OF THE CENTRIFUGAL FAN

Constant Volume Retrofit

The simplest of all air conditioning systems is a supply fan unit serving a single zone with constant air volume as shown in Fig. 7. Typically, this system is controlled by a automatic temperature control (ATC) panel that cycles the AHU starter ON/OFF based on a temperature of a single zone. This is very inefficient and can be converted to variable volume with an air modulator which monitors room temperature and discharge temperature to automatically control fan speed by adjusting the frequency output to the motor.

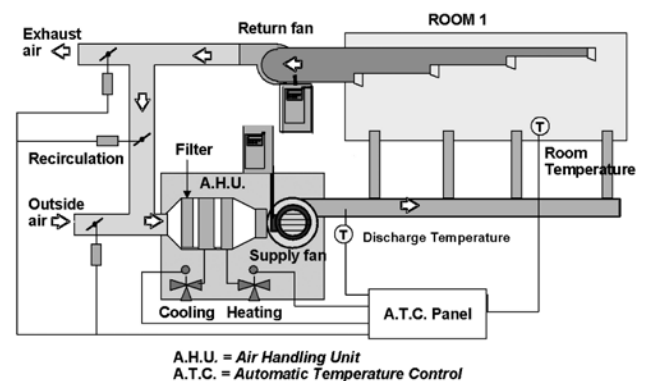

FIGURE 7 - CONSTANT VOLUME SYSTEM - RETROFIT

Direct Expansion VAV System

Air-Modulators can also be used on DX systems. The Air-Modulator can be used to control the supply fan to reduce coil freezing or to control condenser fan speed to optimize head pressure.

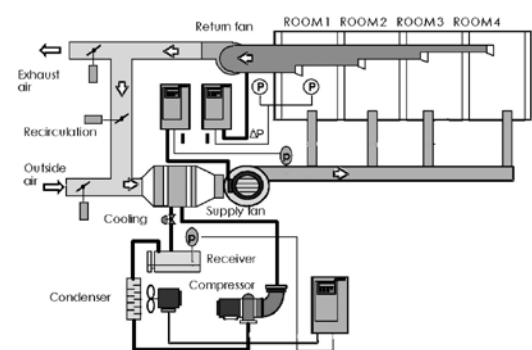

FIGURE 8 - DIRECT EXPANSION VAV SYSTEM

Application (continued)

FAN CONTROL

Theory of Operation

The fan control macro (HVAC PFC) of the JCI Drive provides on/off commands to control up to three constant speed fans operating in parallel with the fan controlled by the drive. The PID Setpoint Controller in the drive controls the process pressure by controlling the speed of the motor connected to the drive and starting additional constant speed motors whenever maximum speed operation of the adjustable speed motor is not sufficient to satisfy the process requirement. This feature can eliminate the need for a PLC.

Adjustments are provided for start and stop points and delay timers. Three step adjustments to the reference and two groups of PID settings can be applied to accommodate different operating characteristics with various numbers of parallel units in operation. An automatic sequence change feature helps ensure equal

duty time for all of the motors. Instead of using the PID controller of the JCI Drive to regulate the process, an open-loop capacity output command can be used to directly set the flow provided by the parallel combination of the fans.

When the fan control feature is used, the adjustable speed motor is connected to a drive output or optional output contactor and the constant speed motor or motors are connected to a motor starter or starters. The optional output contactor and starters are controlled using the JCI Drive's digital (relay) outputs and interlock inputs. Optional digital I/O modules may be required.

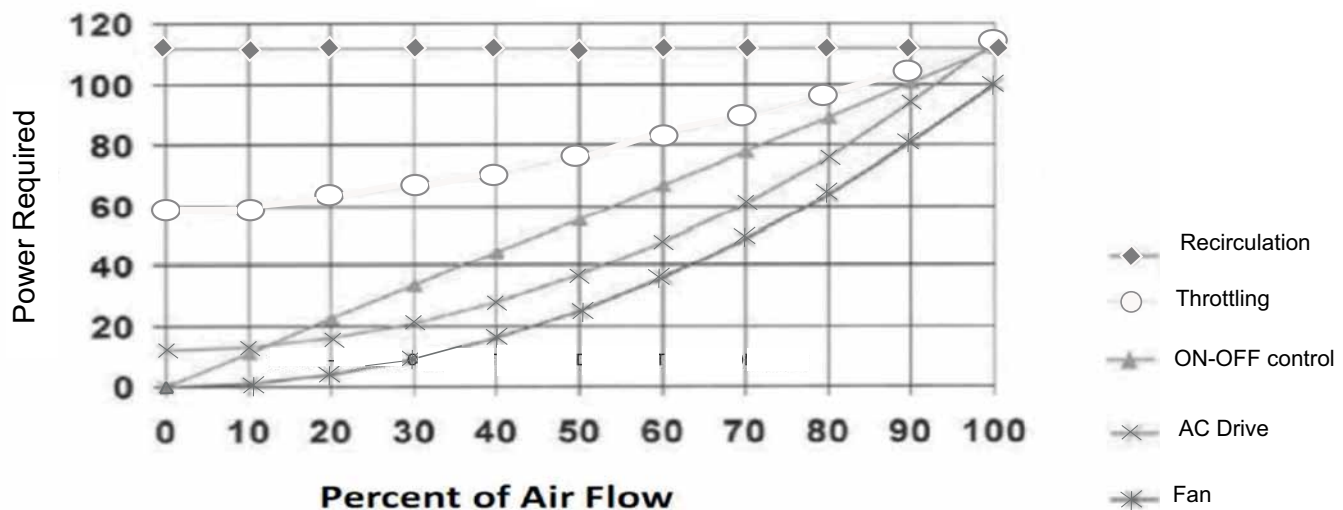

FIGURE 9 - FAN CONTROL

Dimensions

AYK580 FRAME SIZE CHART

Use the chart below to determine overall dimensions based on HP, voltage, and package configuration.

TABLE 1 - AYK580 FRAME SIZE CHART (NEMA 1 / UL TYPE 1 INDOOR)

HP	208 / 230 V				460 V				575 V			
	Current	(-01)	(PF)	(CF)	Current	(-01)	(PF)	(CF)	Current	(-01)	(PF)	(CF)
1	4.6	01-1-R1	PX1-1	CX1-1	2.1	01-1-R1	PX1-1	CX1-1	N/A	N/A	N/A	N/A
1.5	6.6	01-1-R1	PX1-1	CX1-1	3	01-1-R1	PX1-1	CX1-1	N/A	N/A	N/A	N/A
2	7.5	01-1-R1	PX1-1	CX1-1	3.5	01-1-R1	PX1-1	CX1-1	2.7	01-1-R2	PX1-2	CX1-2
3	10.6	01-1-R1	PX1-1	CX1-1	4.8	01-1-R1	PX1-1	CX1-1	3.9	01-1-R2	PX1-2	CX1-2
5	16.7	01-1-R1	PX1-1	CX1-1	7.6	01-1-R1	PX1-1	CX1-1	6.1	01-1-R2	PX1-2	CX1-2
7.5	24.2	01-1-R2	PX1-2	CX1-2	12	01-1-R1	PX1-1	CX1-1	9	01-1-R2	PX1-2	CX1-2
10	30.8	01-1-R2	PX1-2	CX1-2	14	01-1-R2	PX1-2	CX1-2	11	01-1-R2	PX1-2	CX1-2
15	46.2	01-1-R3	PX1-3	CX1-3	23	01-1-R2	PX1-2	CX1-2	17	01-1-R2	PX1-2	CX1-2
20	59.4	01-1-R3	PX1-3	CX1-3	27	01-1-R3	PX1-3	CX1-3	22	01-1-R3	PX1-3	CX1-3
25	74.8	01-1-R4	PX1-4	CX1-4	34	01-1-R3	PX1-3	CX1-3	27	01-1-R3	PX1-3	CX1-3
30	88	01-1-R5	PX1-4	CX1-4	44	01-1-R3	PX1-3	CX1-3	32	01-1-R3	PX1-4	CX1-4
40	114	01-1-R5	PX1-4	CX1-4	52	01-1-R4	PX1-4	CX1-4	41	01-1-R5	PX1-4	CX1-4
50	143	01-1-R6	PX1-6	CX1-6	65	01-1-R4	PX1-4	CX1-4	52	01-1-R5	PX1-4	CX1-4
60	169	01-1-R7	PX1-6	CX1-6	77	01-1-R4	PX1-4	CX1-4	62	01-1-R5	PX1-4	CX1-4
75	211	01-1-R7	PX1-6	CX1-6	96	01-1-R5	PX1-4	CX1-4	77	01-1-R5	PX1-6	CX1-6
100	273	01-1-R8	N/A	N/A	124	01-1-R6	PX1-5	CX1-5	99	01-1-R7	PX1-6	CX1-6
125	N/A	N/A	N/A	N/A	156	01-1-R7	PX1-6	CX1-6	125	01-1-R7	PX1-6	CX1-6
150	N/A	N/A	N/A	N/A	180	01-1-R7	PX1-6	CX1-6	N/A	N/A	N/A	N/A

- 01** Base drive with conduit box as standard
- PF** Base drive with used input disconnect switch
- CF** Base drive with fused input disconnect, classic 2 contactor bypass, drive isolation input fast acting fused service disconnect switch

Note: When mounting drives side by side, allow 2" (50.8mm) on each side to provide clearance for door swing and cooling.

Dimensions (continued)

Base Drive Only (pages 19 to 27) AYK580-01 Nema 1 Option

Frame sizes 1 through 9 (Dimensions shown below are for Options 01)

Nema 1, AYK580-01 Base Drives come standard with a Nema 1 conduit box

TABLE 2 - AYK580-01 NEMA 1 OPTION

UL (NEMA) TYPE 1				BASE DRIVE W/ CONDUIT BOX INCL. AS STD.			
PACK-AGE SIZE	DIMENSIONAL DRAWING NO.	ELECTRICAL DRAWING NO.	DIMENSIONAL REFERENCE	HEIGHT (H)	WIDTH (W)	DEPTH (D)	EST. WEIGHT
				IN	IN	IN	LB
R1	3AXD50000102303	3AXD10000404024	01-1-R1	14.7	4.9	8.8	10
R2	3AXD50000103782	3AXD10000404024	01-1-R2	18.6	4.9	9	15
R3	3AXD50000104215	3AXD10000404024	01-1-R3	19.3	8	9	26
R4	3AXD50000017022	3AXD10000404024	01-1-R4	25	8	10.1	42
R5	3AXD10000404024	3AXD10000404024	01-1-R5	28.8	8	11.6	62
R6	3AXD50000009111	3AXD10000404024	01-1-R6	28.6	9.9	14.5	93
R7	3AXD50000009133	3AXD10000404024	01-1-R7	34.6	11.2	14.6	119
R8	3AXD50000021243	3AXD10000404024	01-1-R8	38	11.8	15.5	152
R9	3AXD50000020646	3AXD10000404024	01-1-R9	37.6	15	16.5	213

Base Drive with fused disconnect (pages 28 to 33) AYK580-PF Nema 1 Option

Enclosures 1 through 6 (Dimensions shown below are for Options PF)

TABLE 3 - AYK580-PF NEMA 1 OPTION

UL (NEMA) TYPE 1				DRIVE W/ MAIN INPUT FUSED DISCONNECT			
PACKAGE SIZE	DIMENSIONAL DRAWING NO.	ELECTRICAL DRAWING NO.	"DIM REF"	HEIGHT (H)	WIDTH (W)	DEPTH (D)	EST. WEIGHT
				IN	IN	IN	LB
Box 1	3AXD50000488797	3AXD50000490134	PX1-1	20.75	8.25	11.731	50
Box 2	3AXD50000489220	3AXD50000490134	PX1-2	26.75	8.25	12.161	48
Box 3	3AXD50000489343	3AXD50000490134	PX1-3	32.5	9	11.981	50
Box 4	3AXD50000489350	3AXD50000490134	PX1-4	40.5	12	15.231	82
Box 5	3AXD50000489367	3AXD50000490134	PX1-5	43	12	17.897	172
Box 6	3AXD50000489169	3AXD50000490134	PX1-6	48	16	18.188	235

Base Drive with main input fused disconnect, classic two contactor bypass and drive isolation fast acting fused service switch (pages 34 to 42) AYK580-CF Nema 1 Option

Enclosures 1 through 6 (Dimensions shown below are for Options CF)

TABLE 4 - AYK580-CF NEMA 1 OPTION

UL (NEMA) TYPE 1				DRIVE W/ MAIN INPUT FUSED DISCONNECT, BYPASS & FUSED SERVICE SWITCH			
PACKAGE SIZE	DIMENSIONAL DRAWING NO.	ELECTRICAL DRAWING NO.	"DIM REF"	HEIGHT (H)	WIDTH (W)	DEPTH (D)	EST. WEIGHT
				IN	IN	IN	LB
Box 1	3AXD50000490103	3AXD50000489268	CX1-1	23.000	18.000	15.971	58
Box 2	3AXD50000490226	3AXD50000489268	CX1-2	26.502	18	16.033	71
Box 3	3AXD50000490325	3AXD50000489268	CX1-3	28.505	22	16.005	93
Box 4	3AXD50000490141	3AXD50000489268	CX1-4	40	31	18.006	243
Box 5	3AXD50000490332	3AXD50000489268	CX1-5	44	33	20.533	311
Box 6	3AXD50000490769	3AXD50000489268	CX1-6	44.994	32.996	20.533	402

R Frame Drawing # 3AXD50000102303	Customer Designation R1 580-01 Base Drive
--	---

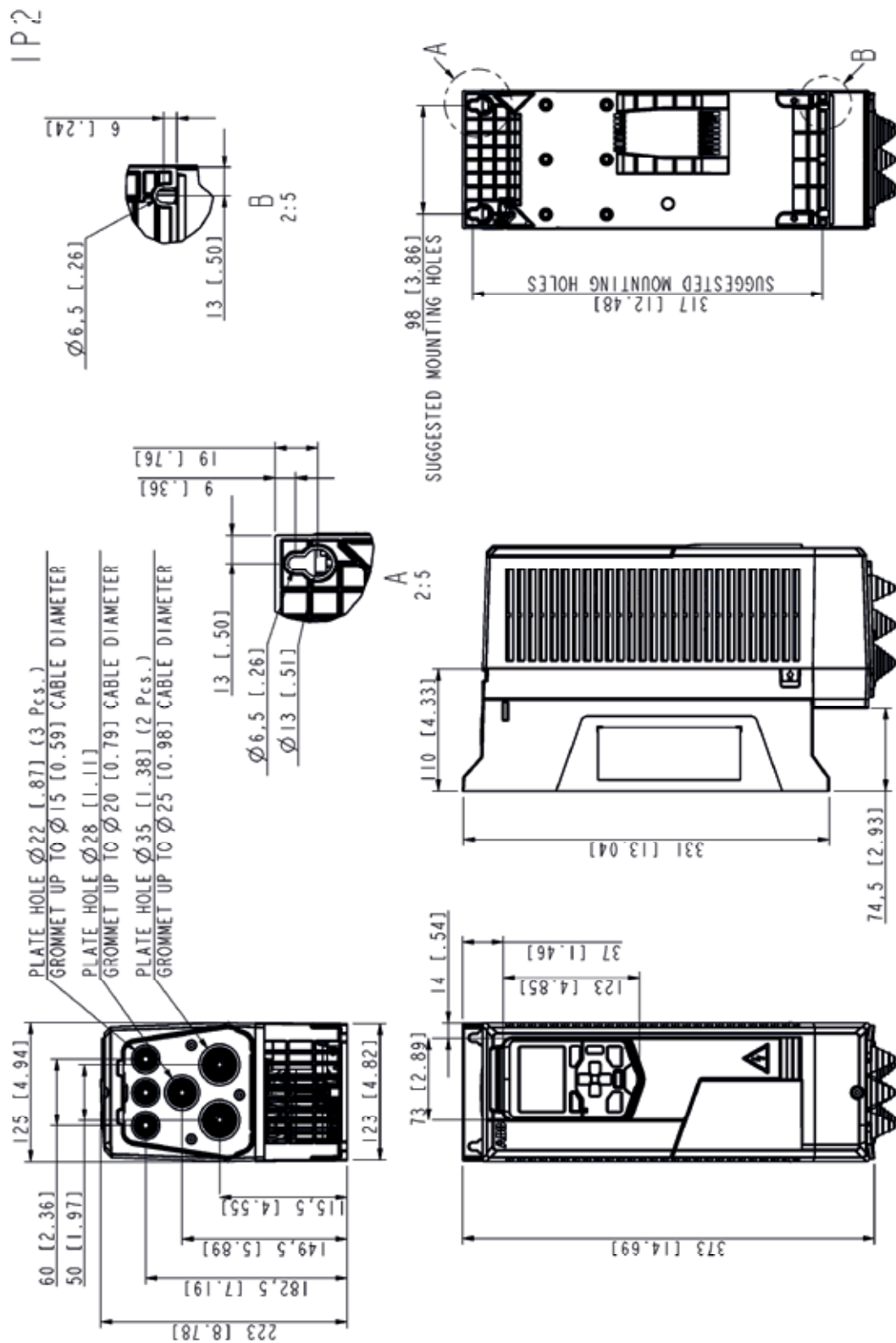

FIGURE 10 - R1 FRAME DIMENSIONS

Dimensions (continued)

R Frame Drawing # 3AXD50000103782	Customer Designation R2 580-01 Base Drive
---	---

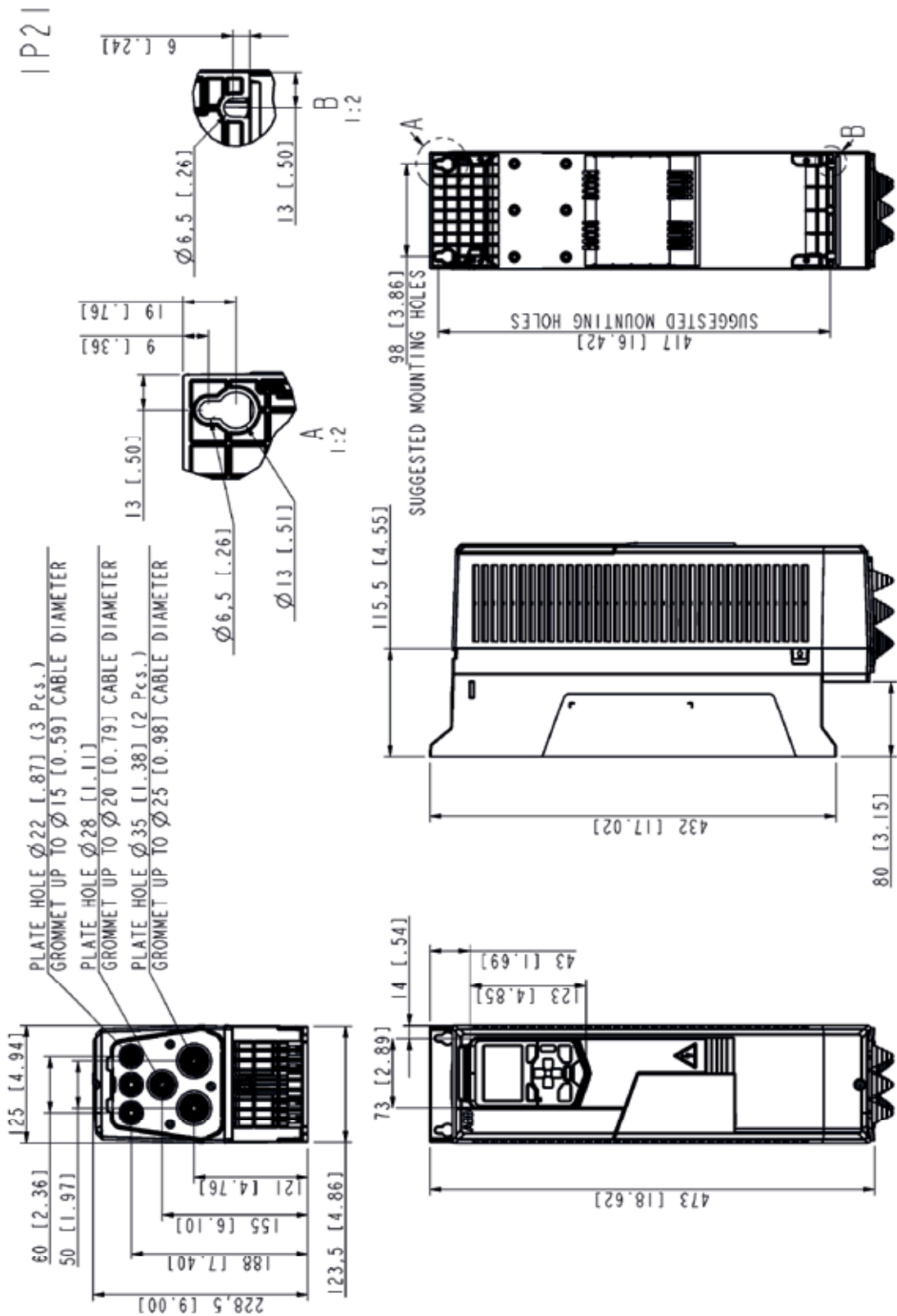

FIGURE 11 - R2 FRAME DIMENSIONS

R Frame Drawing # 3AXD50000104215	Customer Designation R3 580-01 Base Drive
--	---

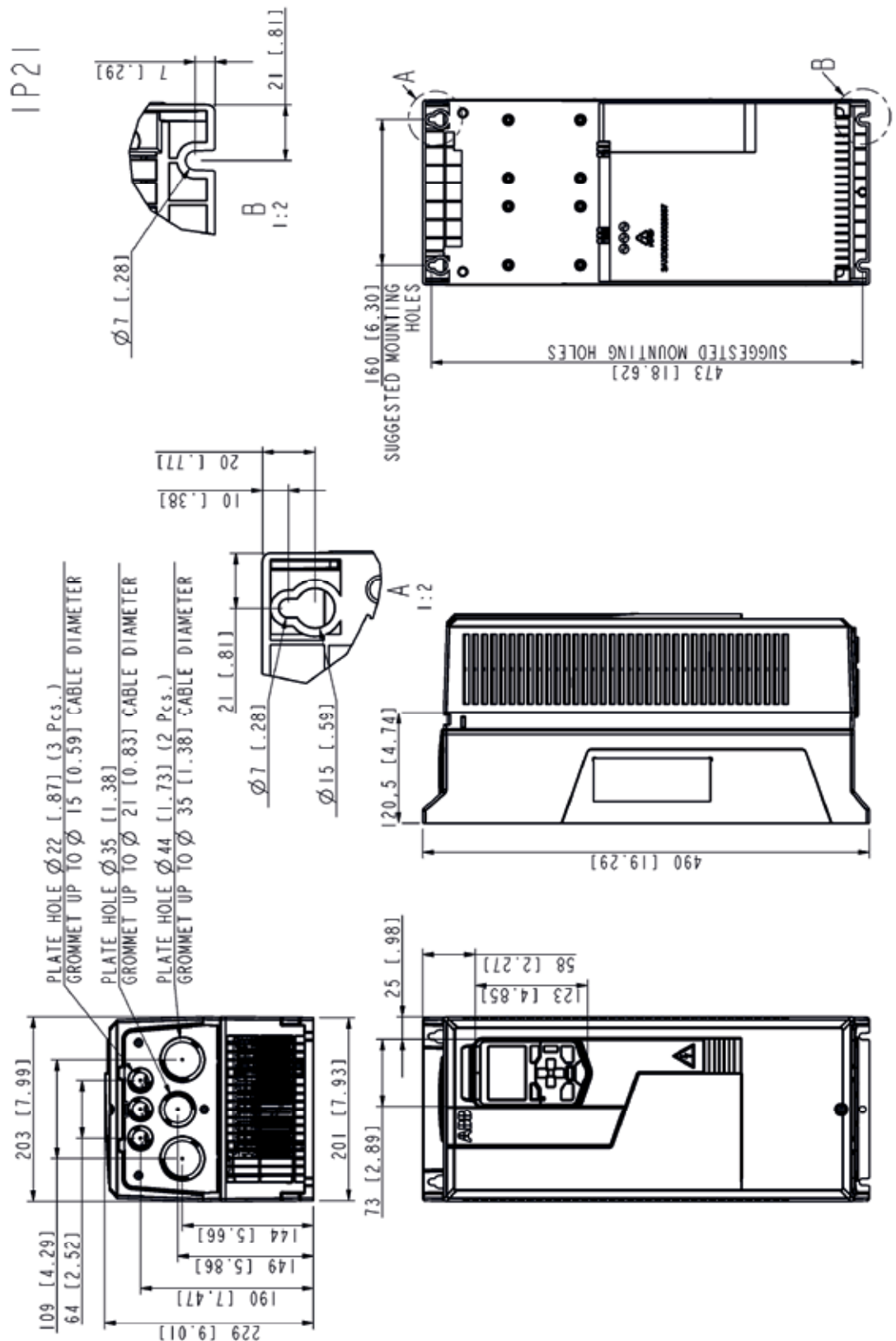

FIGURE 12 - R3 FRAME DIMENSIONS

Dimensions (continued)

R Frame Drawing # 3AXD50000017022	Customer Designation R4 580-01 Base Drive
---	---

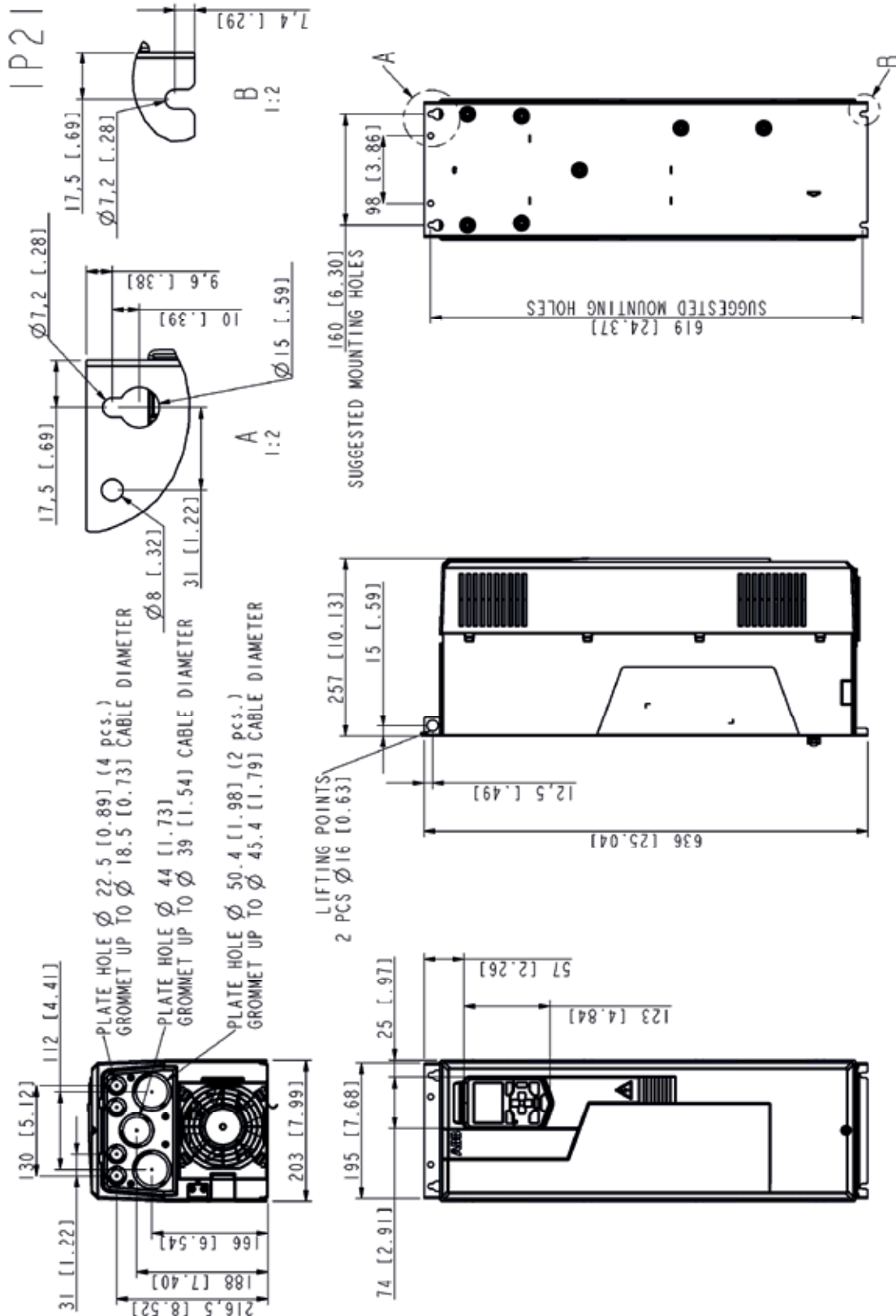

FIGURE 13 - R4 FRAME DIMENSIONS

R Frame Drawing # 3AXD50000025387	Customer Designation R5 580-01 Base Drive
--	---

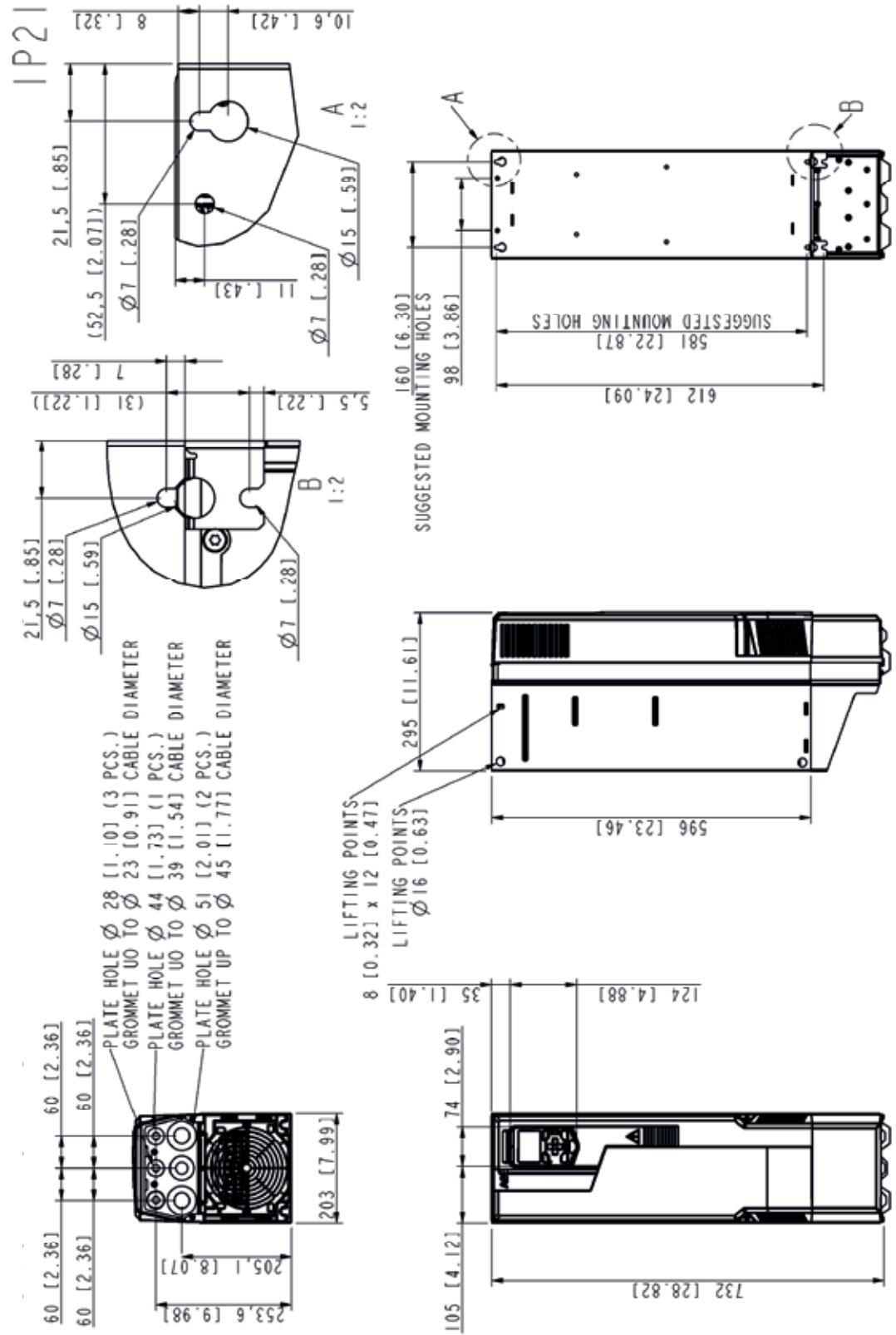

FIGURE 14 - R5 FRAME DIMENSIONS

Dimensions (continued)

R Frame Drawing # 3AXD5000009111	Customer Designation R6 580-01 Base Drive
--	---

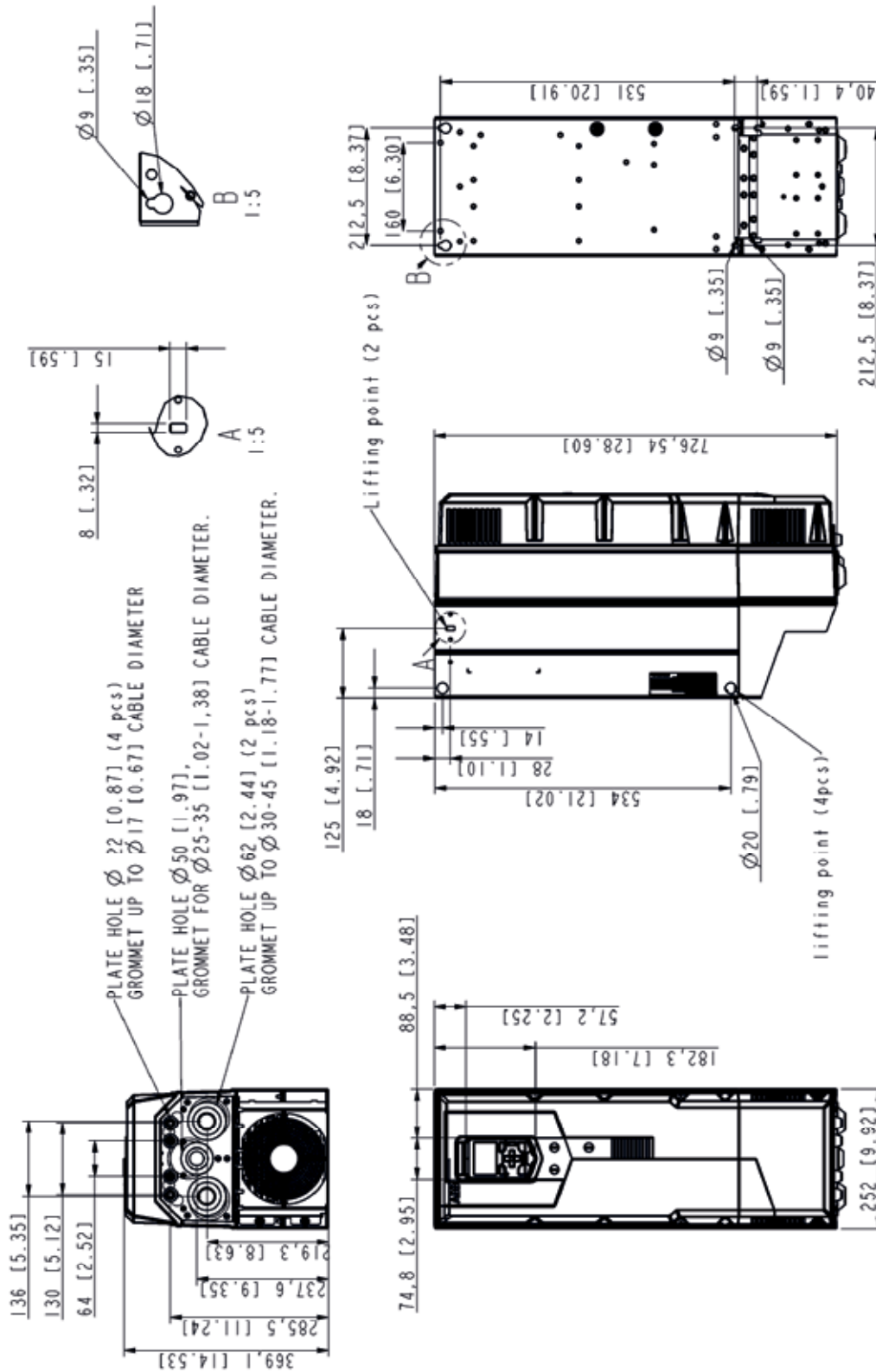

FIGURE 15 - R6 FRAME DIMENSIONS

R Frame Drawing #
3AXD5000009133

Customer Designation
 R7 580-01 Base Drive

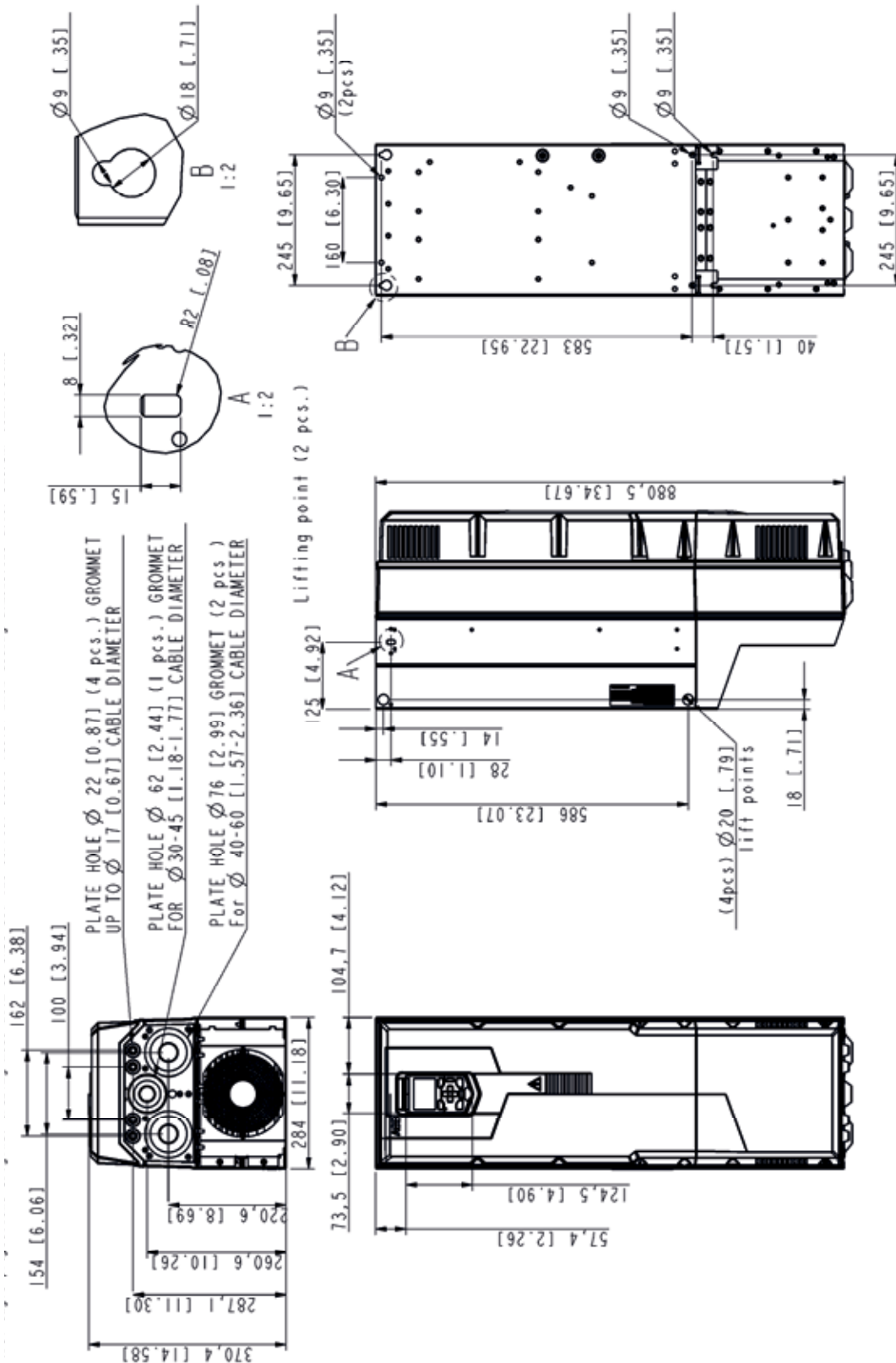

FIGURE 16 - R7 FRAME DIMENSIONS

Dimensions (continued)

R Frame Drawing # 3AXD5000021243	Customer Designation R8 580-01 Base Drive
--	---

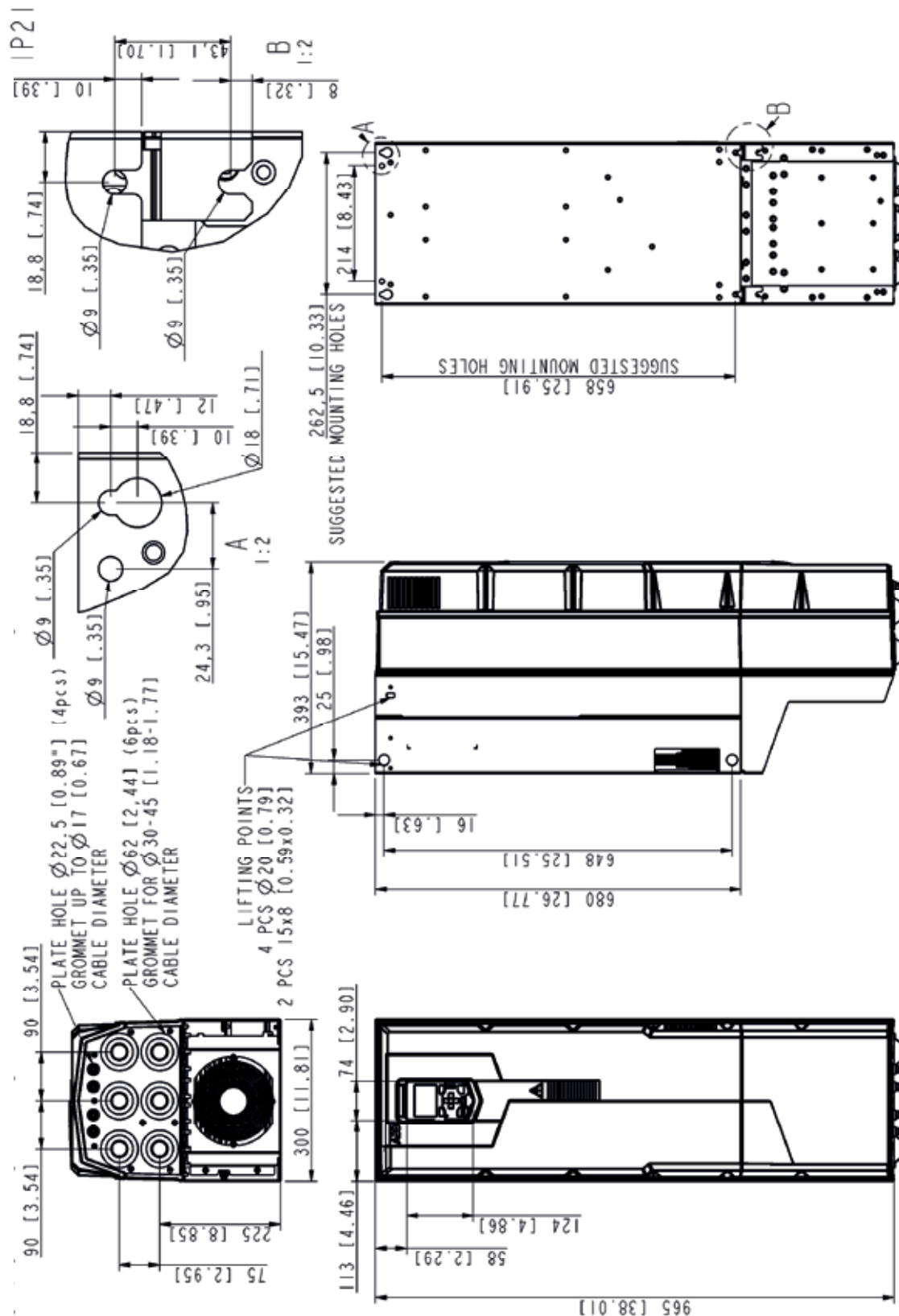

FIGURE 17 - R8 FRAME DIMENSIONS

Dimensions (continued)

R Frame Drawing # 3AXD5000020646	Customer Designation R9 580-01 Base Drive
--	---

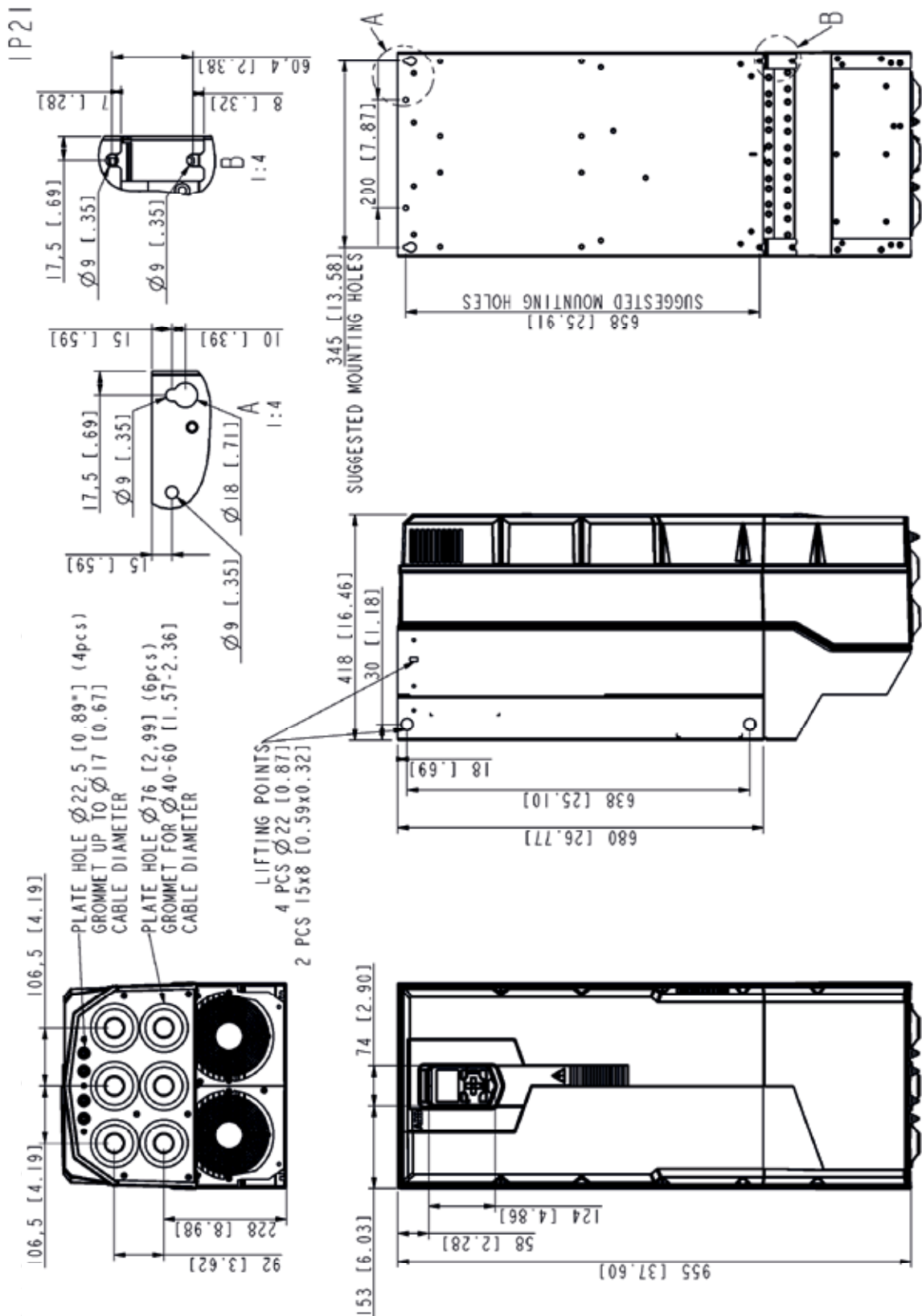

FIGURE 18 - R9 FRAME DIMENSIONS

Dimensions (continued)

Drawing #: 3AXD50000488797

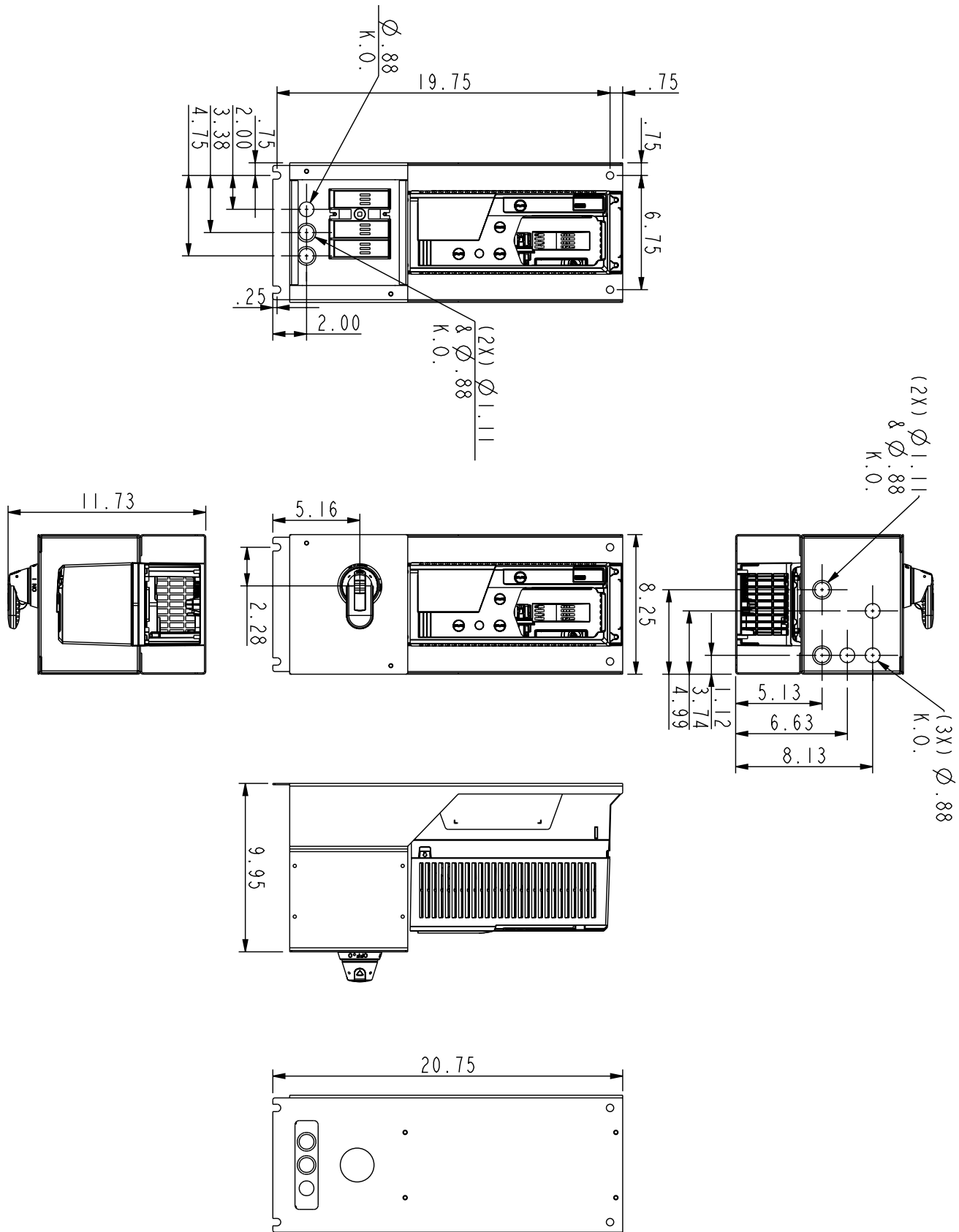

FIGURE 19 - NI BOX 1 DISCONNECT ONLY

Dimensions (continued)

Drawing #: 3AXD50000489220

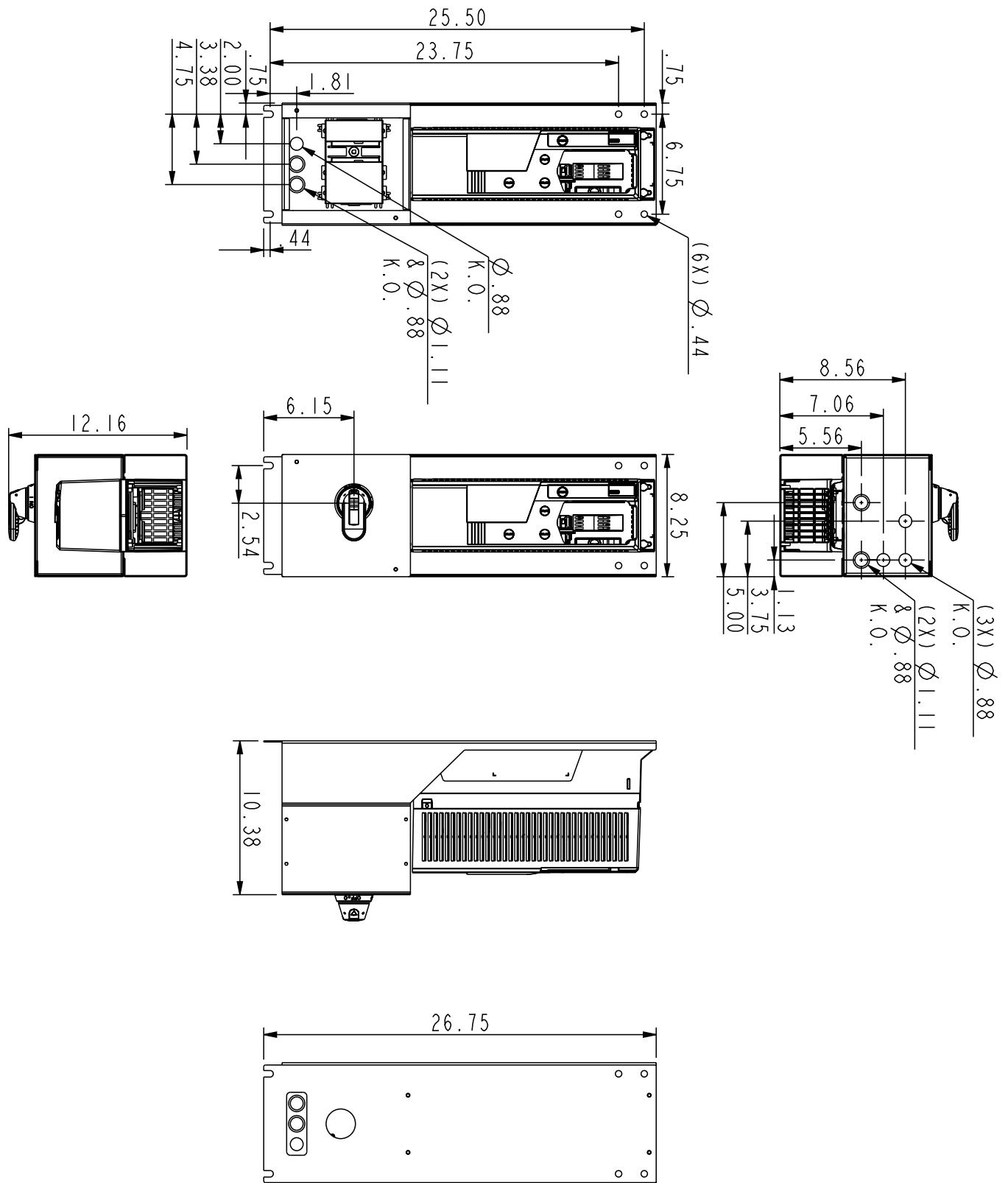

FIGURE 20 - NI BOX 2 DISCONNECT ONLY

Dimensions (continued)

Drawing #: 3AXD50000489343

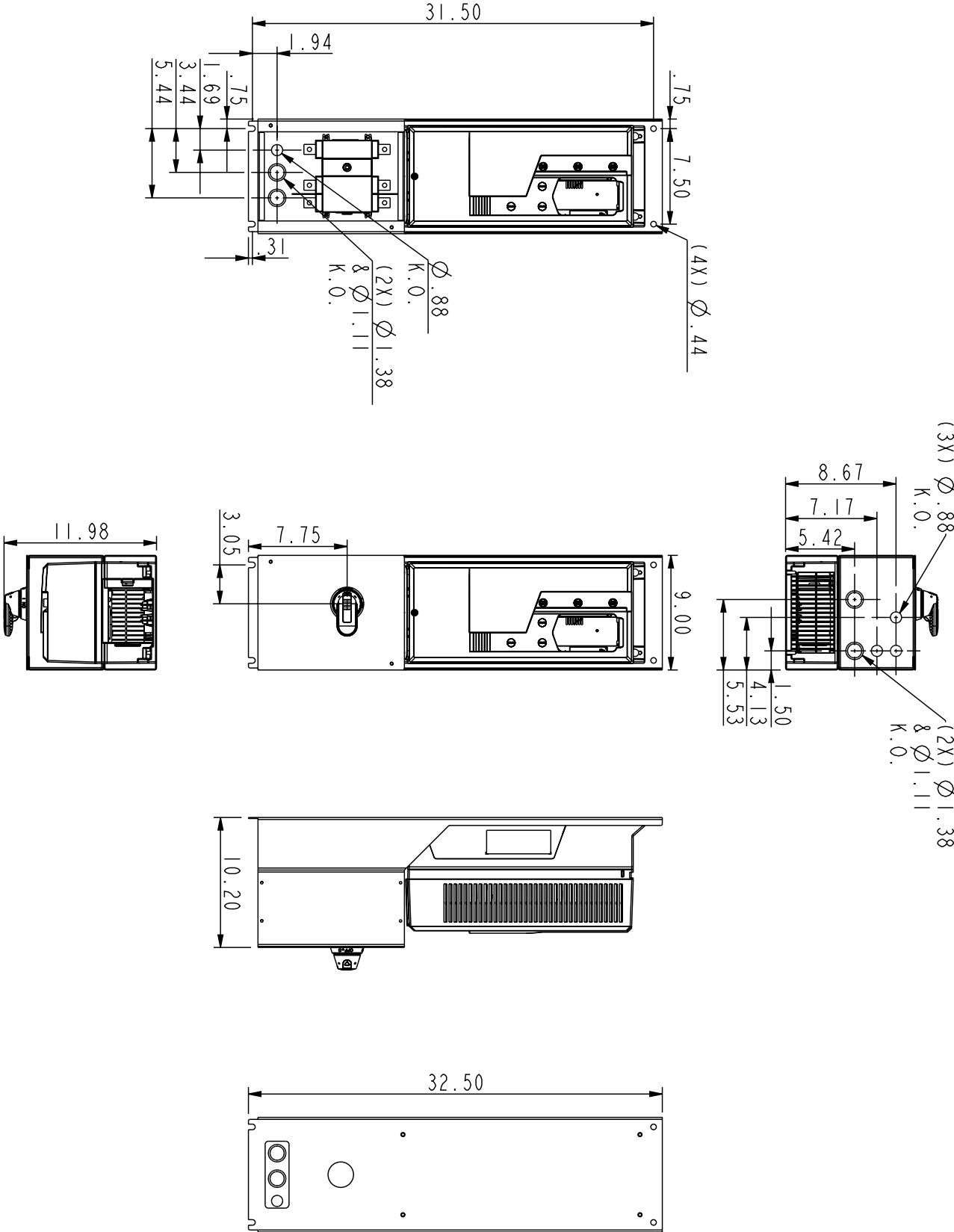

FIGURE 21 - NI BOX 3 DISCONNECT ONLY

Dimensions (continued)

Drawing #: 3AXD50000489350

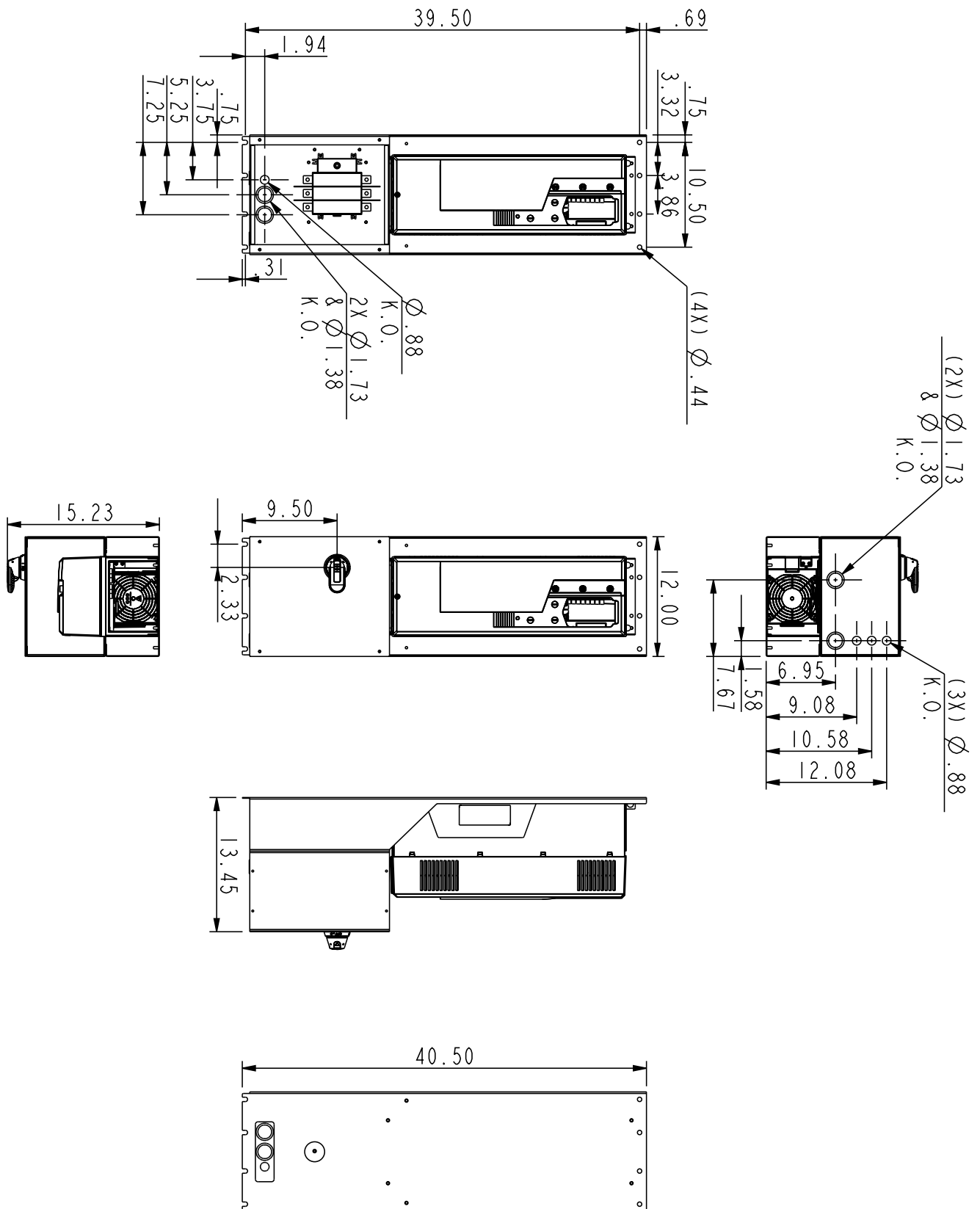

FIGURE 22 - NI BOX 4 DISCONNECT ONLY

Dimensions (continued)

Drawing #: 3AXD50000489367

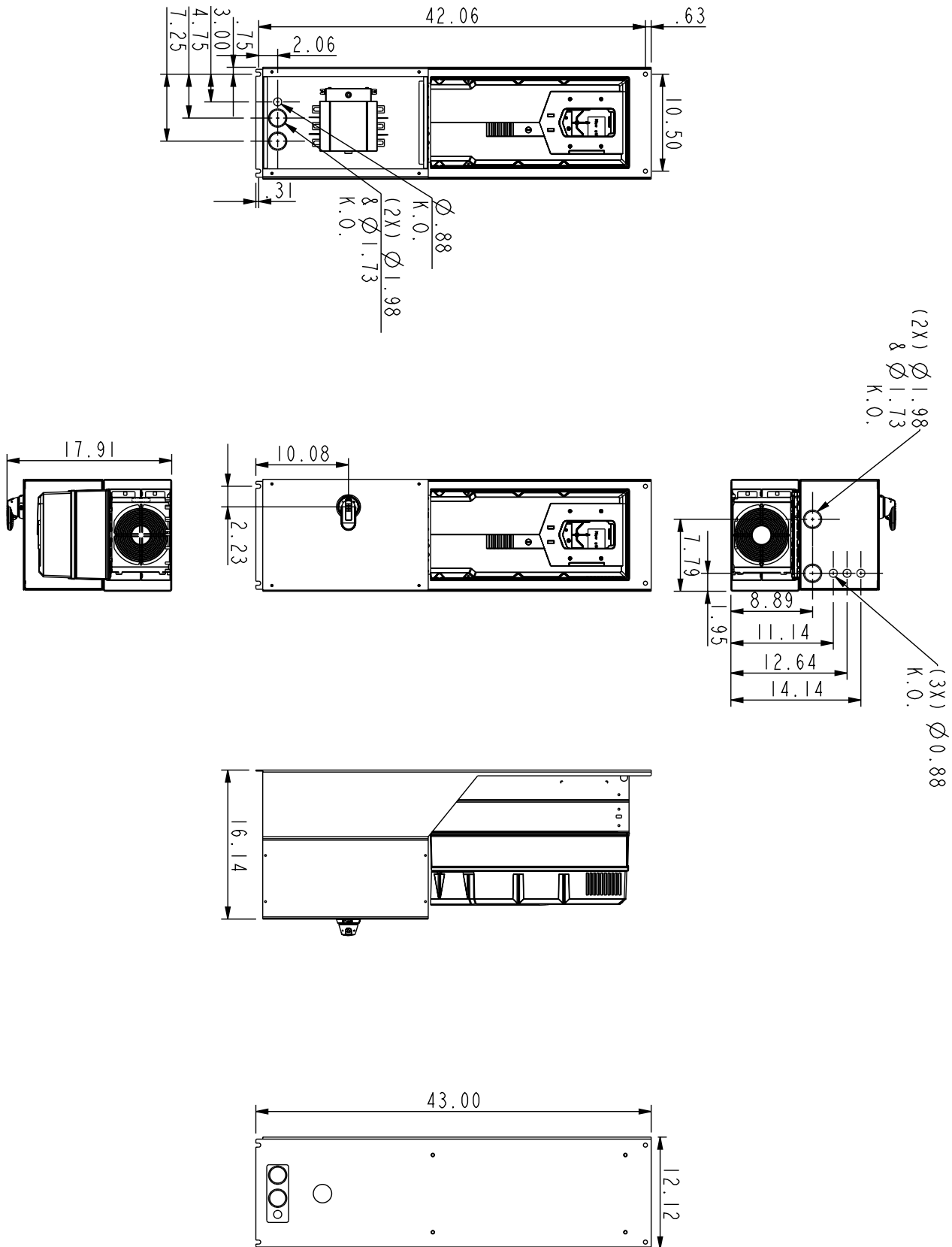

FIGURE 23 - NI BOX 5 DISCONNECT ONLY

Dimensions (continued)

Drawing #: 3AXD50000489169

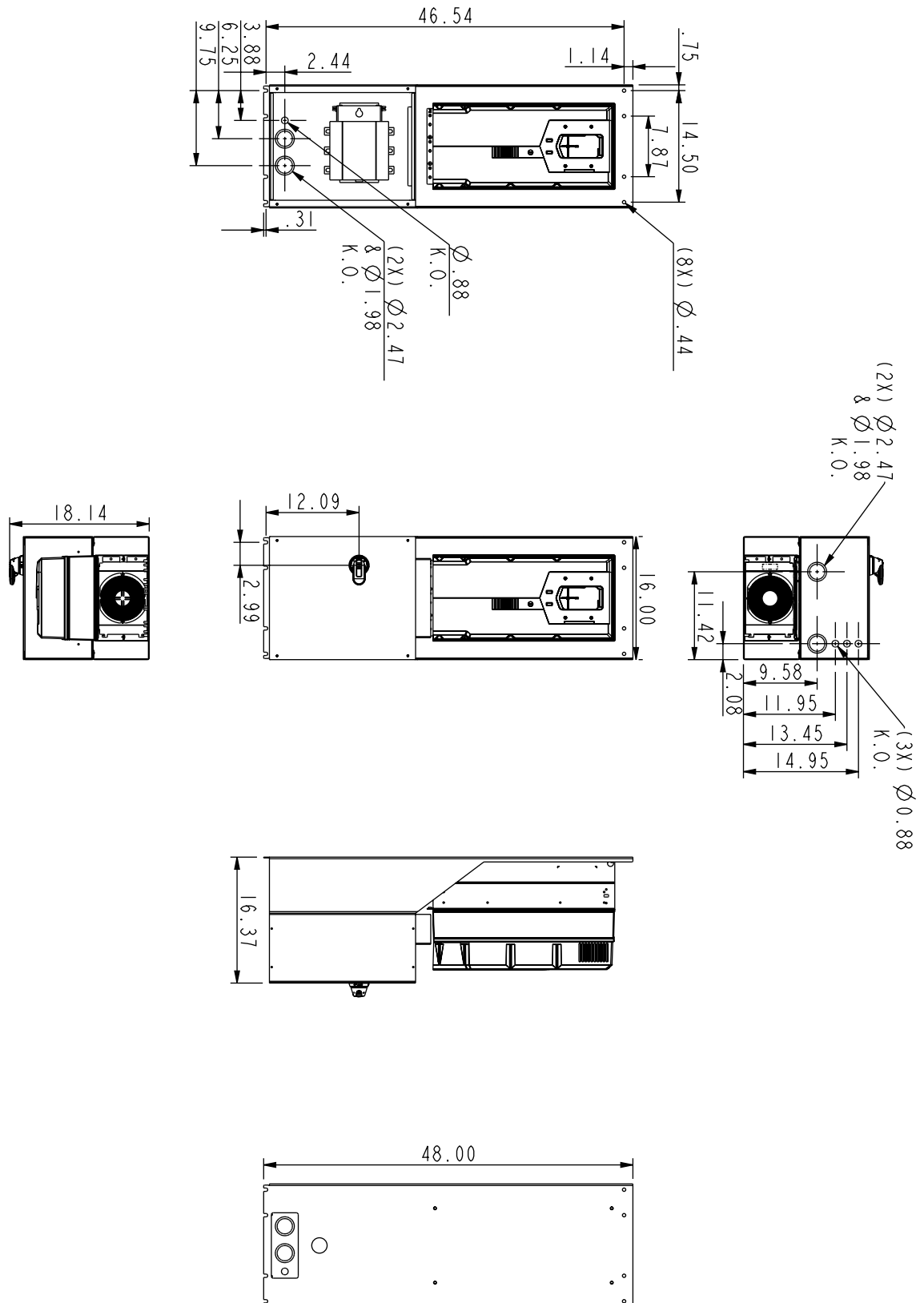

FIGURE 24 - NI BOX 6 DISCONNECT ONLY

Dimensions (continued)

Drawing #: 3AXD50000490103

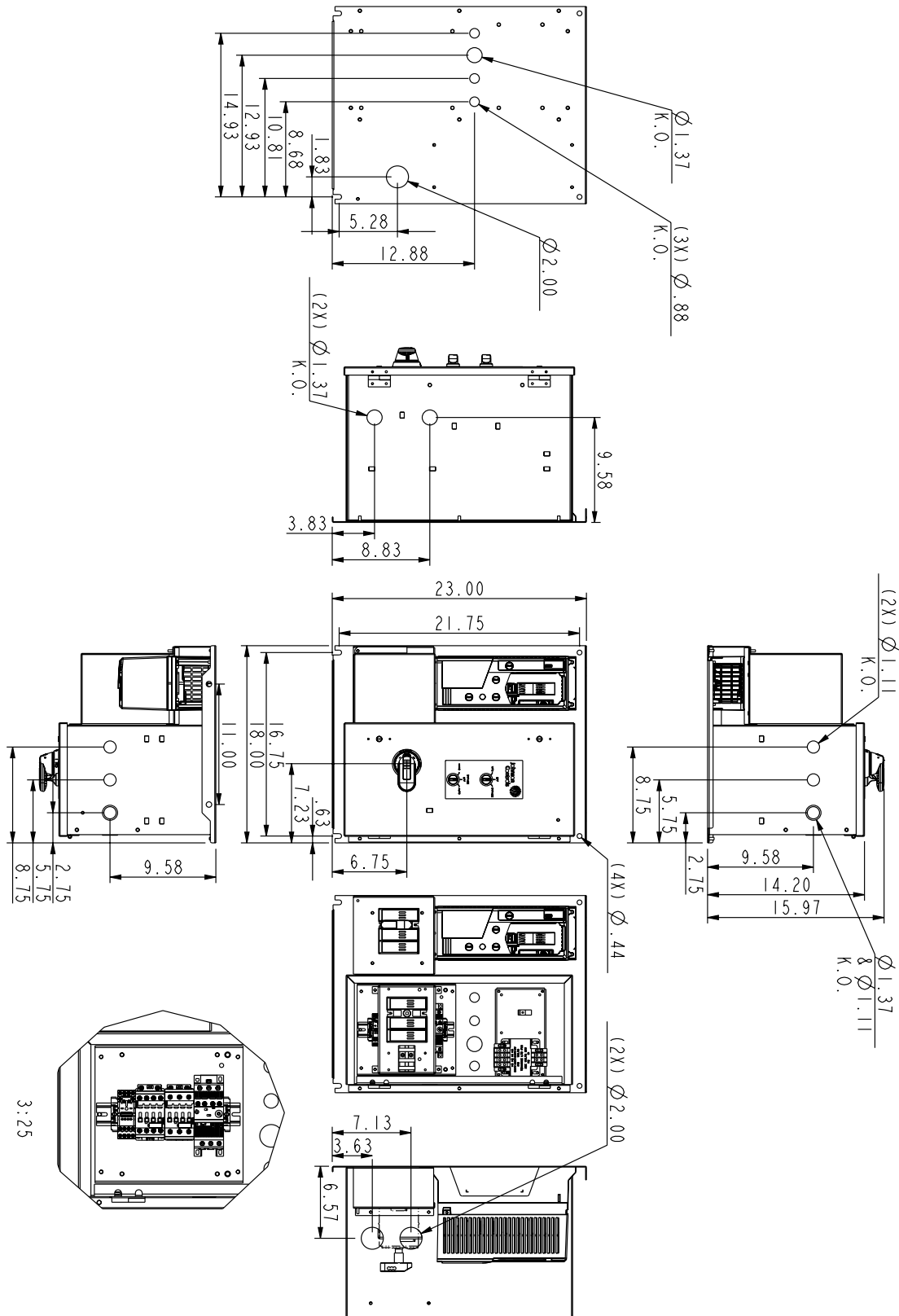

FIGURE 25 - NI BYPASS BOX 1

Dimensions (continued)

Drawing #: 3AXD50000490103

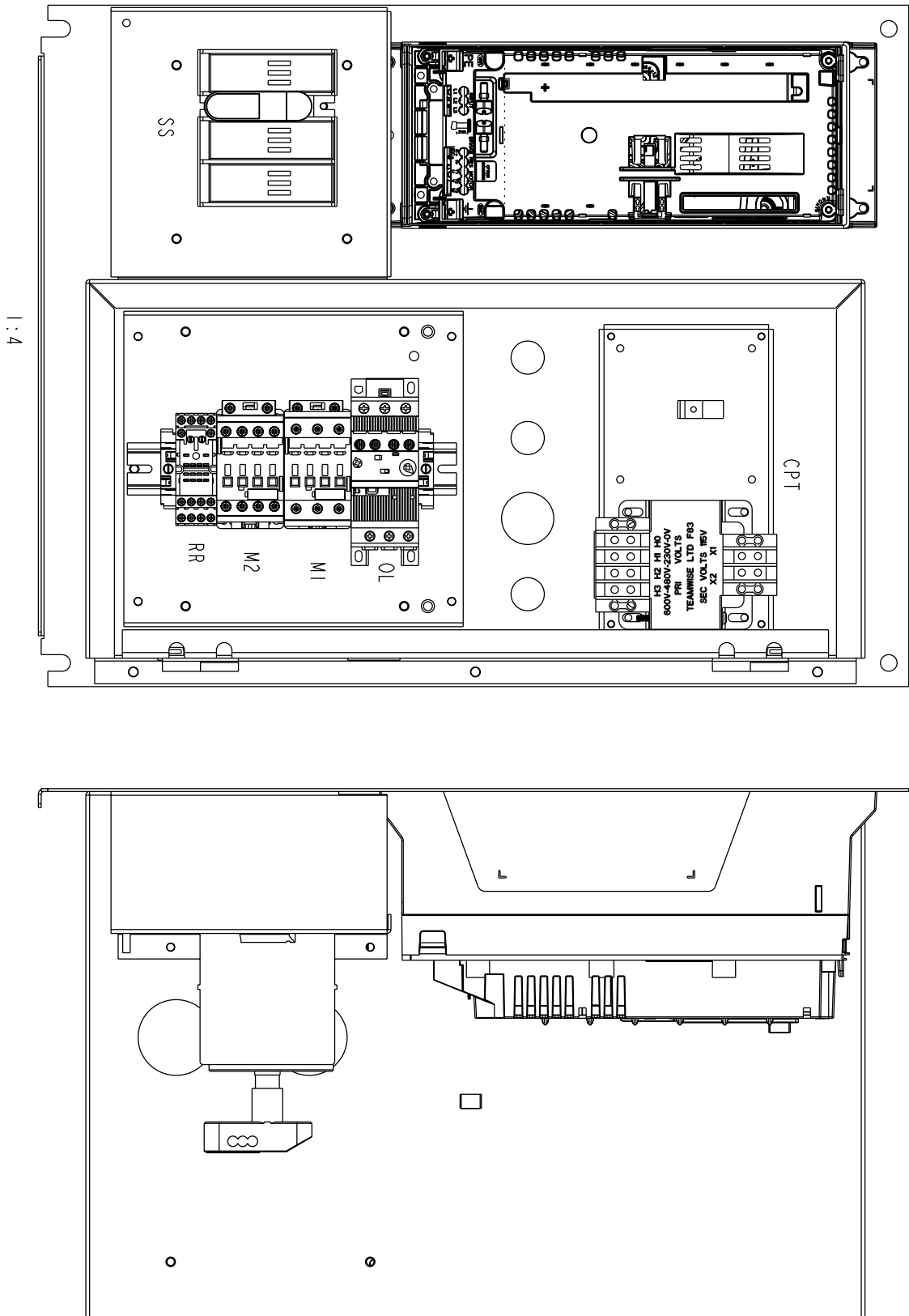

FIGURE 25 - NI BYPASS BOX 1 (CONT'D)

Dimensions (continued)

Drawing #: 3AXD50000490226

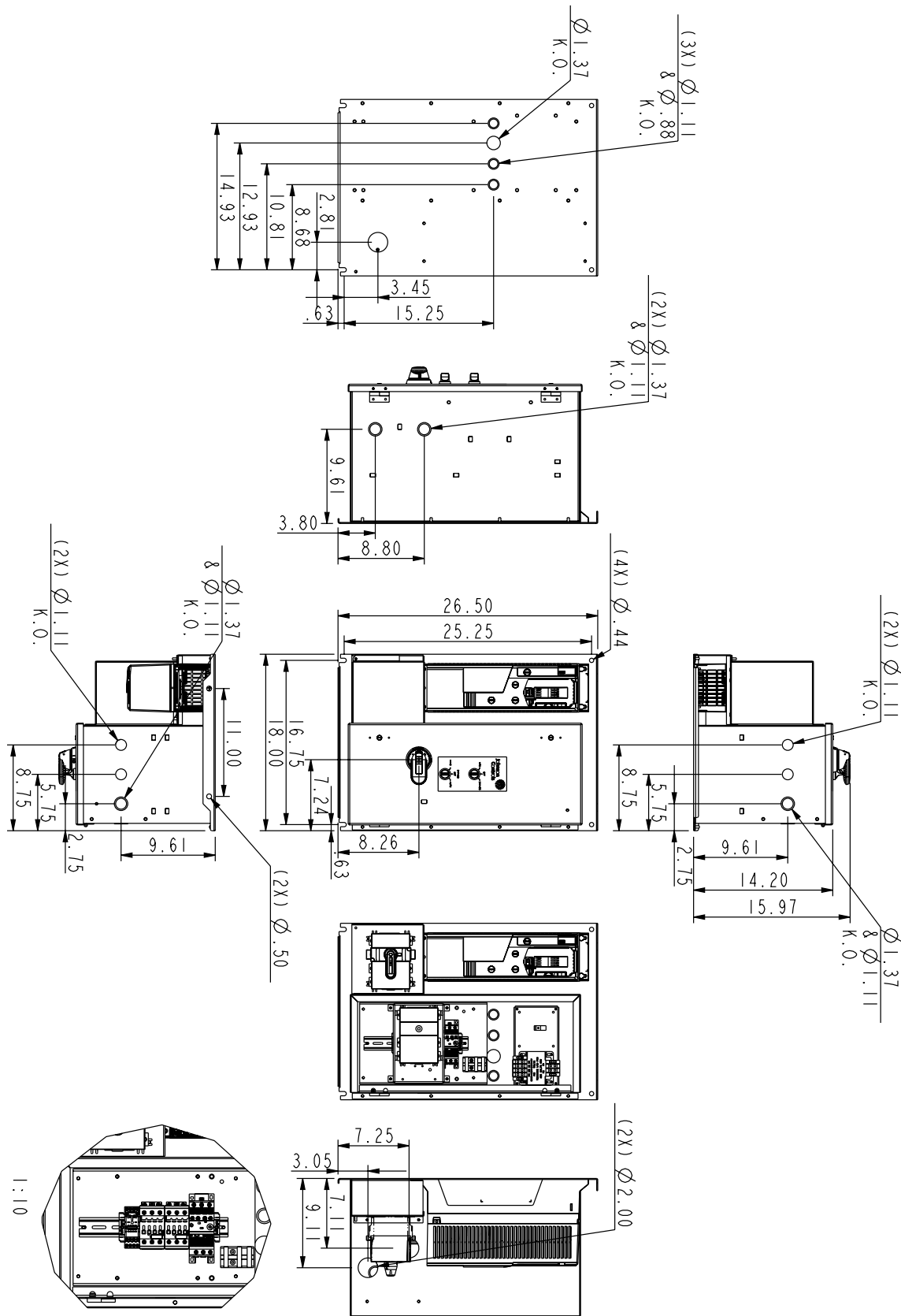

FIGURE 26 - NI BYPASS BOX 2

Dimensions (continued)

Drawing #: 3AXD50000490226

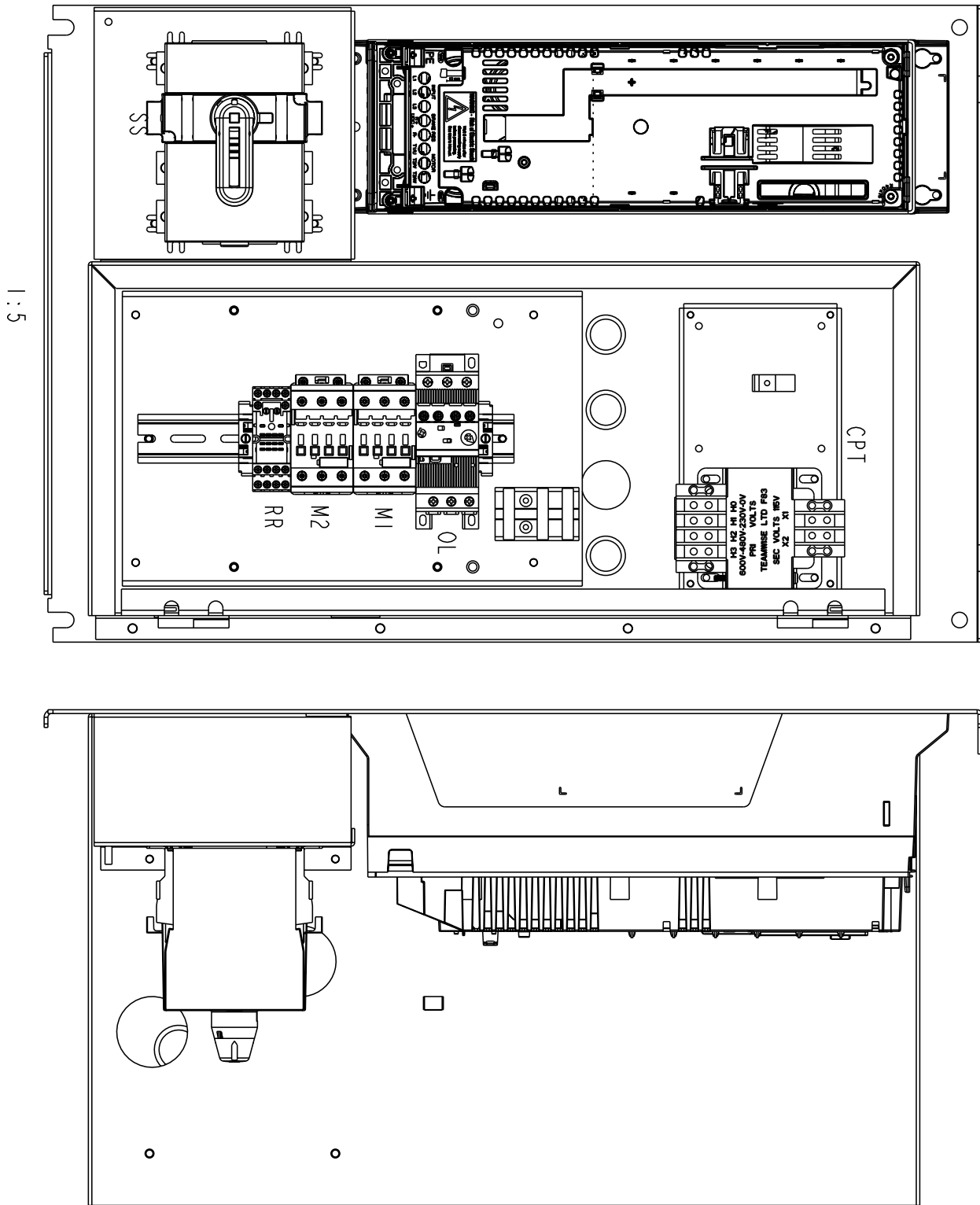

FIGURE 26 - NI BYPASS BOX 2 (CONT'D)

Dimensions (continued)

Drawing #: 3AXD50000490325

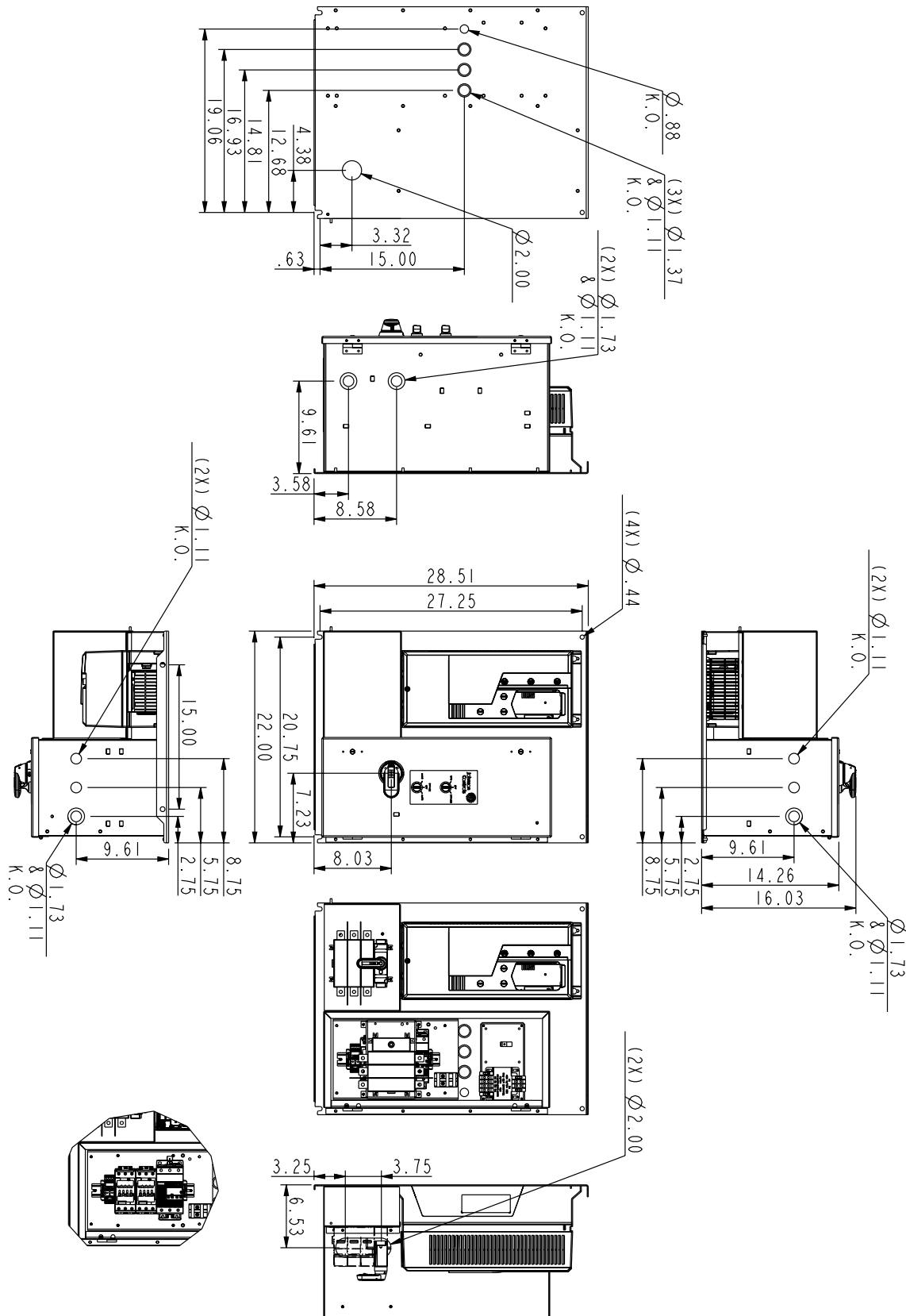

FIGURE 27 - NI BYPASS BOX 3

Dimensions (continued)

Drawing #: 3AXD50000490325

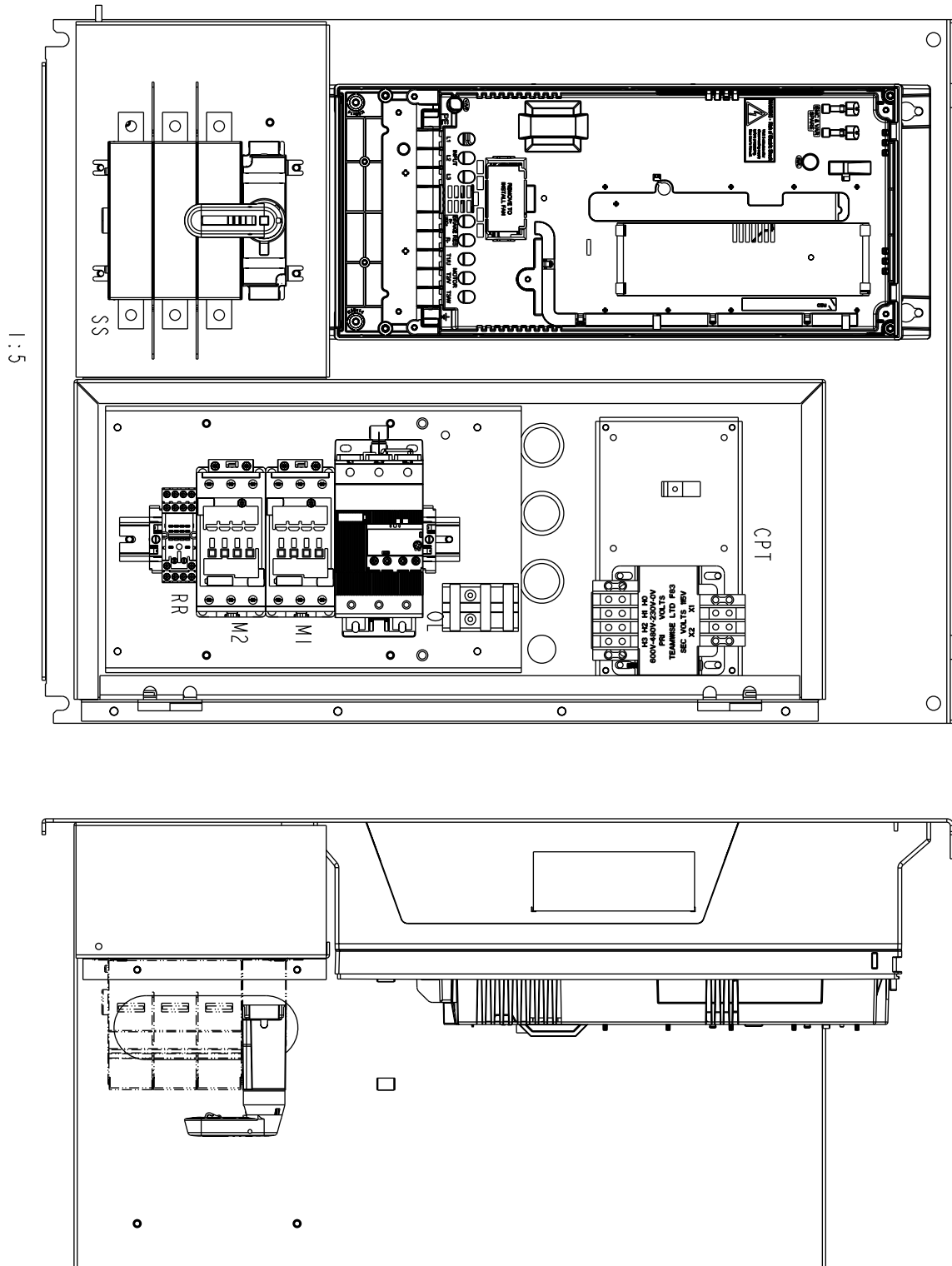

FIGURE 27 - NI BYPASS BOX 3 (CONT'D)

Dimensions (continued)

Drawing #: 3AXD50000490141

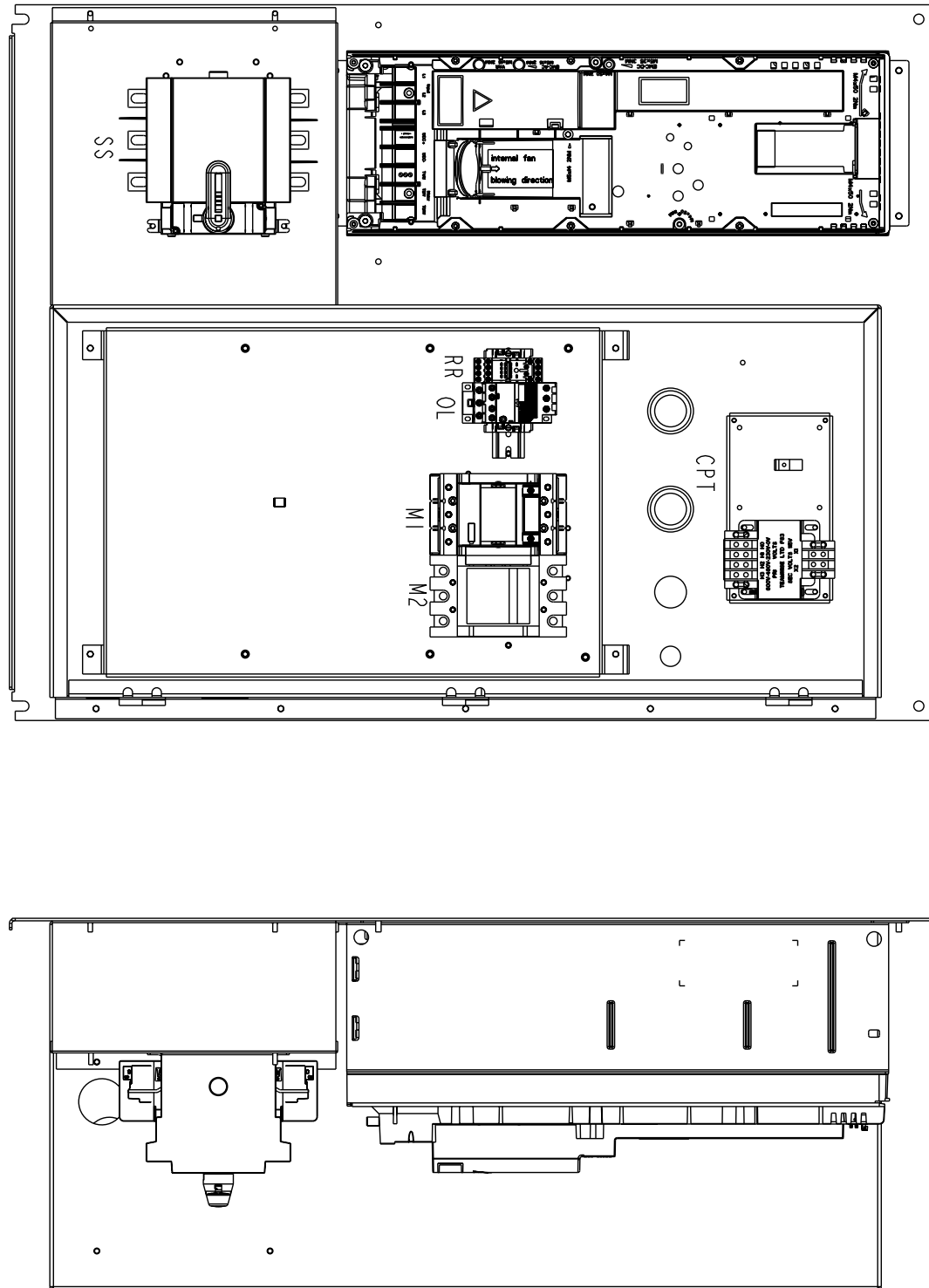

FIGURE 28 - NI BYPASS BOX 4 (CONT'D)

Dimensions (continued)

Drawing #: 3AXD50000490332

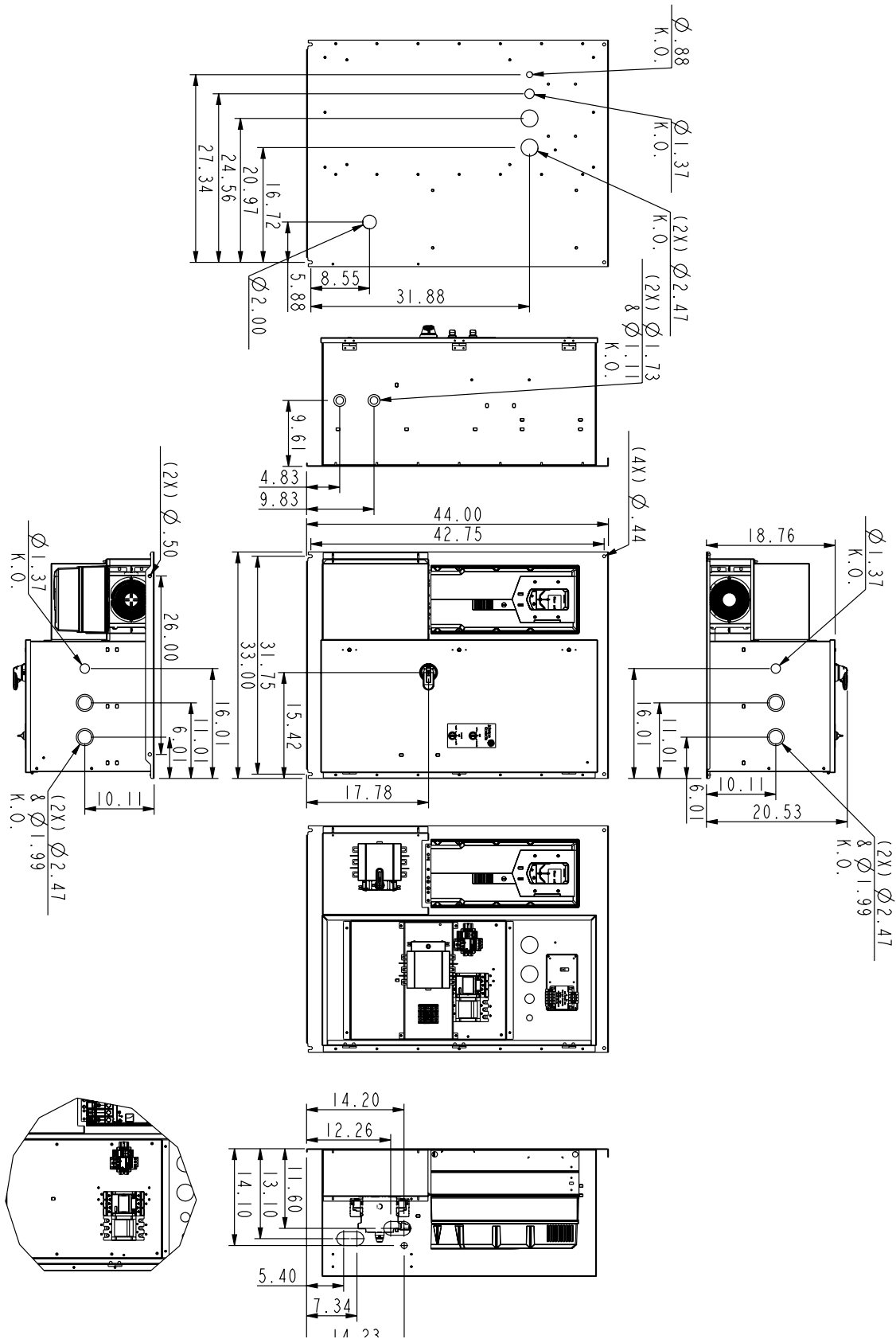

FIGURE 29 - NI BYPASS BOX 5

Dimensions (continued)

Drawing #: 3AXD50000490332

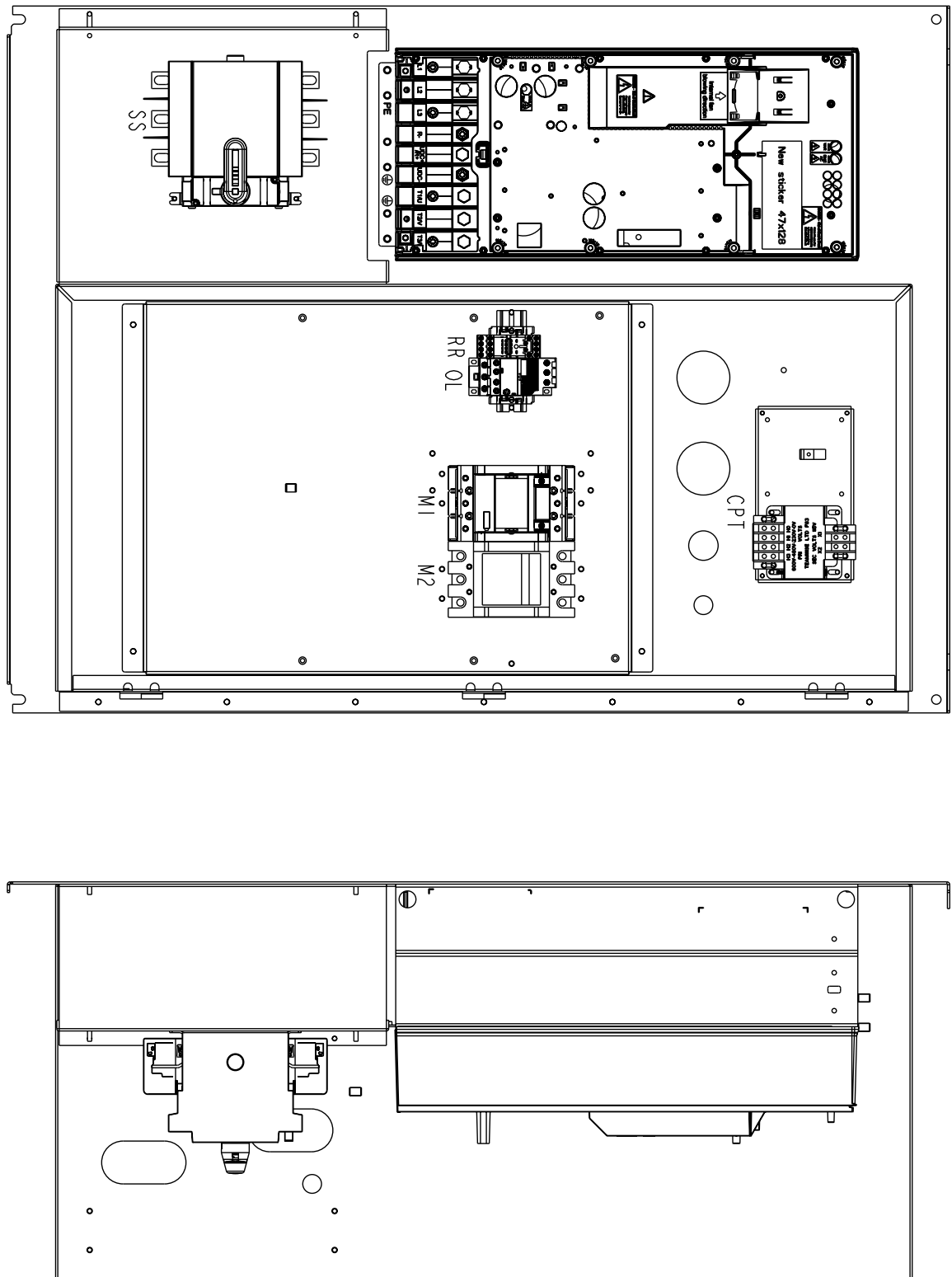

FIGURE 29 - NI BYPASS BOX 5 (CONT'D)

Dimensions (continued)

Drawing #: 3AXD50000490769

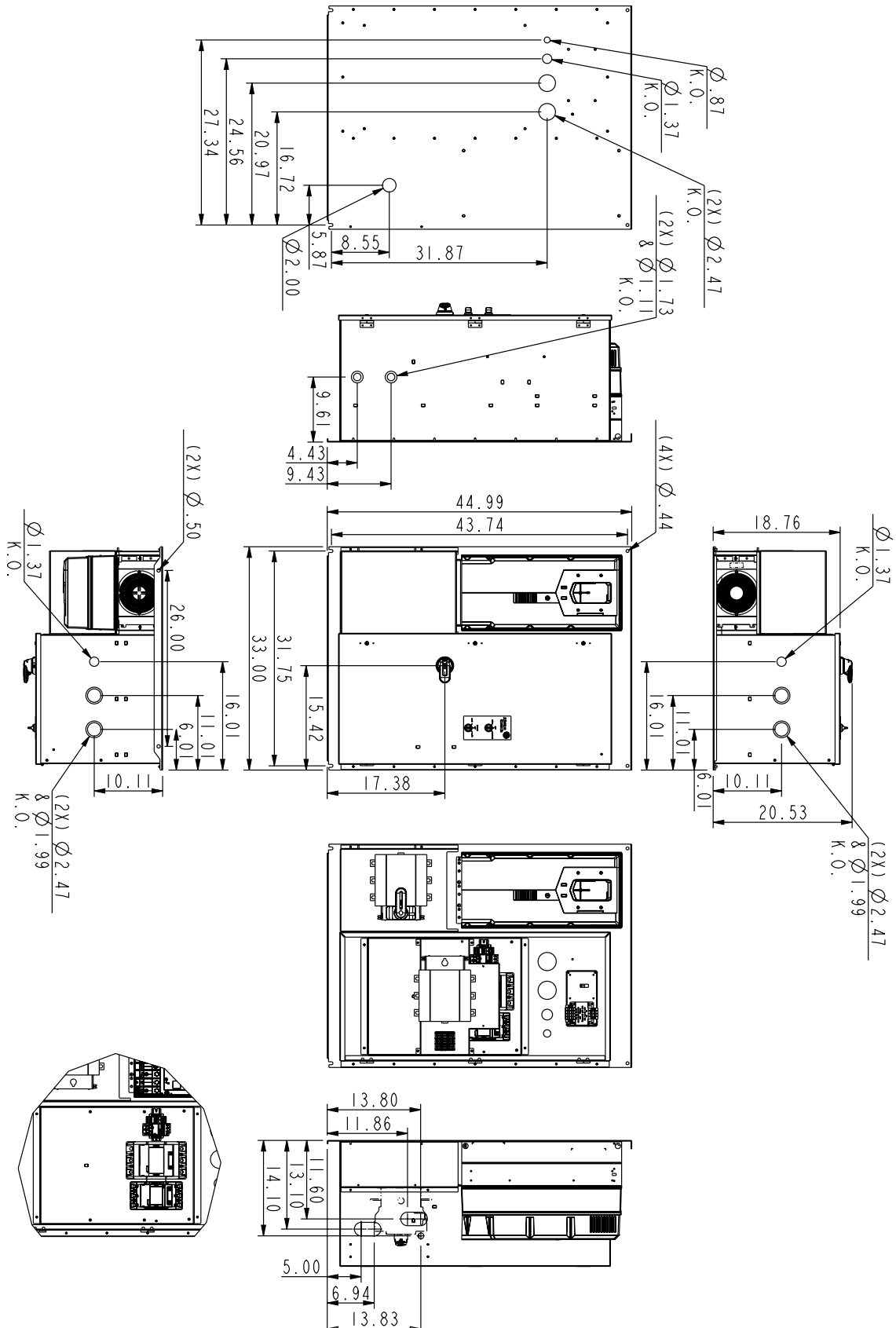

FIGURE 30 - NI BYPASS BOX 6

Dimensions (continued)

Drawing #: 3AXD50000490769

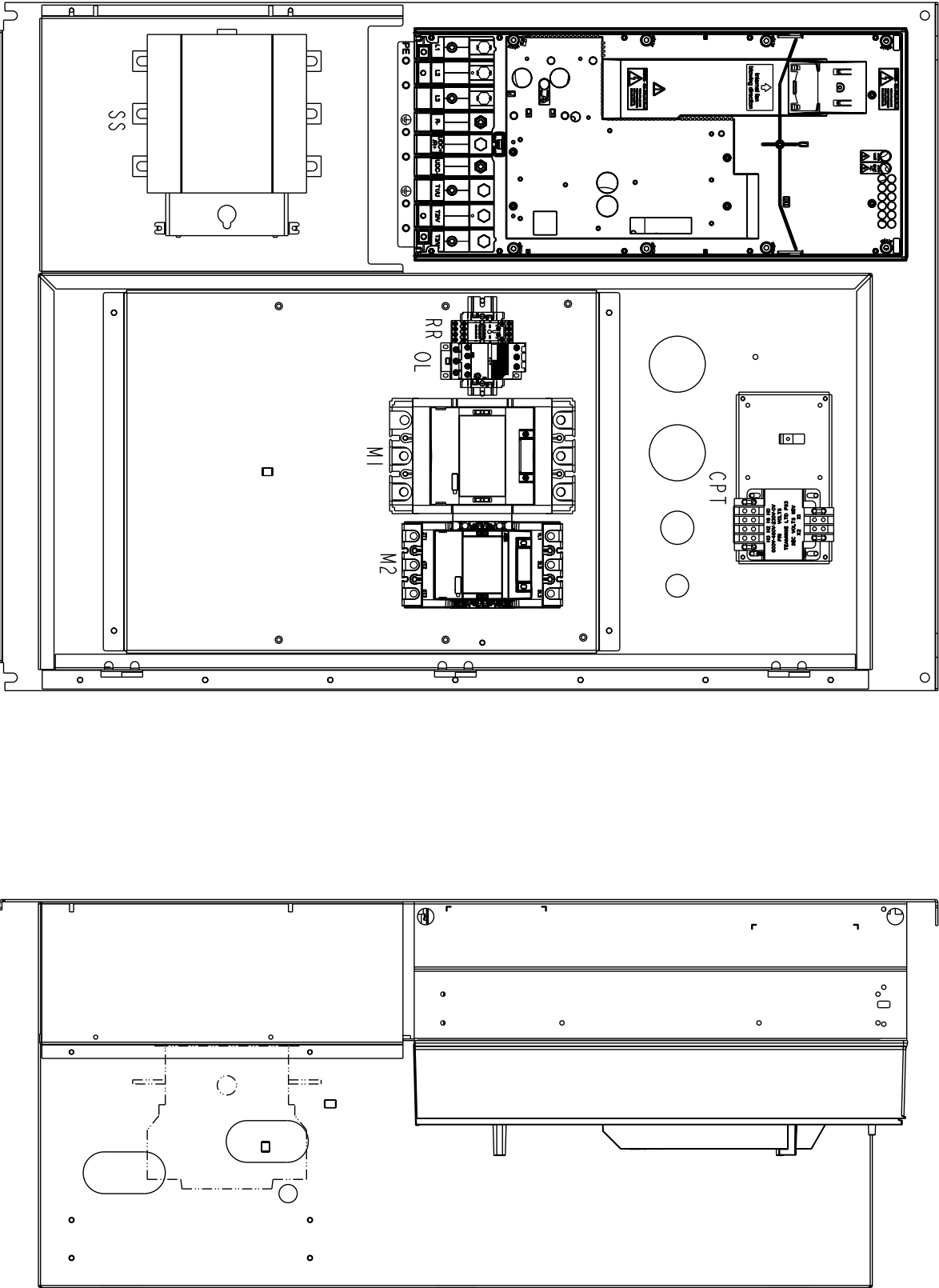

FIGURE 30 - NI BYPASS BOX 6 (CONT'D)

Dimensions (continued)

Use the chart below to determine the overall dimensions based on HP, current, voltage, and package configuration.

TABLE 5 - AYK 580 FRAME SIZE CHART (NEMA 3R/UL TYPE 3R OUTDOOR)

HP	208/230 V			460 V			575 V		
	CUR-RENT	(PF)	(CF)	CUR-RENT	(PF)	(CF)	CUR-RENT	(PF)	(CF)
1	4.6	PX3R-1	CX3R-1	2.1	PX3R-1	CX3R-1	N/A	N/A	N/A
1.5	6.6	PX3R-1	CX3R-1	3	PX3R-1	CX3R-1	N/A	N/A	N/A
2	7.5	PX3R-1	CX3R-1	3.5	PX3R-1	CX3R-1	2.7	PX3R-2	CX3R-2
3	10.6	PX3R-1	CX3R-1	4.8	PX3R-1	CX3R-1	3.9	PX3R-2	CX3R-2
5	16.7	PX3R-1	CX3R-1	7.6	PX3R-1	CX3R-1	6.1	PX3R-2	CX3R-2
7.5	24.2	PX3R-2	CX3R-2	12	PX3R-1	CX3R-1	9	PX3R-2	CX3R-2
10	30.8	PX3R-2	CX3R-2	14	PX3R-2	CX3R-2	11	PX3R-2	CX3R-2
15	46.2	PX3R-3	CX3R-3	23	PX3R-2	CX3R-2	17	PX3R-2	CX3R-2
20	59.4	PX3R-3	CX3R-3	27	PX3R-3	CX3R-3	22	PX3R-3	CX3R-3
25	74.8	PX3R-4	CX3R-4	34	PX3R-3	CX3R-3	27	PX3R-3	CX3R-3
30	88	PX3R-4	CX3R-4	44	PX3R-3	CX3R-3	32	PX3R-4	CX3R-4
40	114	PX3R-4	CX3R-4	52	PX3R-4	CX3R-4	41	PX3R-4	CX3R-4
50	143	PX3R-6	CX3R-6	65	PX3R-4	CX3R-4	52	PX3R-4	CX3R-4
60	169	PX3R-6	CX3R-6	77	PX3R-4	CX3R-4	62	PX3R-4	CX3R-4
75	211	PX3R-6	CX3R-6	96	PX3R-4	CX3R-4	77	PX3R-6	CX3R-6
100	273	N/A	N/A	124	PX3R-5	CX3R-5	99	PX3R-6	CX3R-6
125	N/A	N/A	N/A	156	PX3R-6	CX3R-6	125	PX3R-6	CX3R-6
150	N/A	N/A	N/A	180	PX3R-6	CX3R-6	N/A	N/A	N/A

PF+B058 - Base drive with fused input disconnect switch

CF+B058 - Base drive with fused input disconnect, classic 2 contactor bypass, drive isolation input fast acting fused service disconnect switch

Note: When mounting drives side by side, allow 2 in. (50.8 mm) on each side to provide clearance for door swing and cooling.

Dimensions (continued)

Base drive with fused disconnect
(Pages to) AYK590-PF+B058 Nema 3R Option
 Enclosures 1 through 6. The following dimensions are for options PF+B058.

TABLE 6 - AYK580-PF+B058 NEMA 3R OPTION

UL (NEMA) TYPE 3R				DRIVE W/ MAIN INPUT FUSED DISCONNECT			
PACKAGE SIZE	DIMENSIONAL DRAWING NO.	ELECTRICAL DRAWING NO.	"DIM REF"	HEIGHT (H)	WIDTH (W)	DEPTH (D)	EST. WEIGHT
				IN	IN	IN	LB
Box 1	3AXD50000494781	3AXD50000490134	PX3R-1	22.427	15.158	14.359	49
Box 2	3AXD50000495030	3AXD50000490134	PX3R-2	28.432	15.158	14.359	64
Box 3	3AXD50000495146	3AXD50000490134	PX3R-3	35.103	18.520	14.359	151
Box 4	3AXD50000496563	3AXD50000490134	PX3R-4	45.568	18.52	16.54	214
Box 5	3AXD50000495221	3AXD50000490134	PX3R-5	49.682	21.77	18.54	273
Box 6	3AXD50000496747	3AXD50000490134	PX3R-6	56.755	21.935	21.537	392

Base drive with main input fused disconnect, classic two contactor bypass and drive isolation fast acting fused service switch
(Pages to) AYK580-CF+B058 Nema 3R Option
 Enclosures 1 through 6. The following dimensions are for Options CF+B058.

UL (NEMA) TYPE 3R				DRIVE W/ MAIN INPUT FUSED DISCONNECT, BYPASS & FUSED SERVICE SWITCH			
PACKAGE SIZE	DIMENSIONAL DRAWING NO.	ELECTRICAL DRAWING NO.	"DIM REF"	HEIGHT (H)	WIDTH (W)	DEPTH (D)	EST. WEIGHT
				IN	IN	IN	LB
Box 1	3AXD50000495078	3AXD50000489268	CX3R-1	20.507	18.000	17.359	70
Box 2	3AXD50000495597	3AXD50000489268	CX3R-2	27.507	20.158	17.359	84
Box 3	3AXD50000496419	3AXD50000489268	CX3R-3	32.731	22.52	17.359	175
Box 4	3AXD50000496938	3AXD50000489268	CX3R-4	45.49	28.52	18.54	273
Box 5	3AXD50000496334	3AXD50000489268	CX3R-5	46.181	32.52	22.462	394
Box 6	3AXD50000499632	3AXD50000489268	CX3R-6	53.177	32.52	22.462	485

Dimensions (continued)

Drawing #: 3AXD50000494781

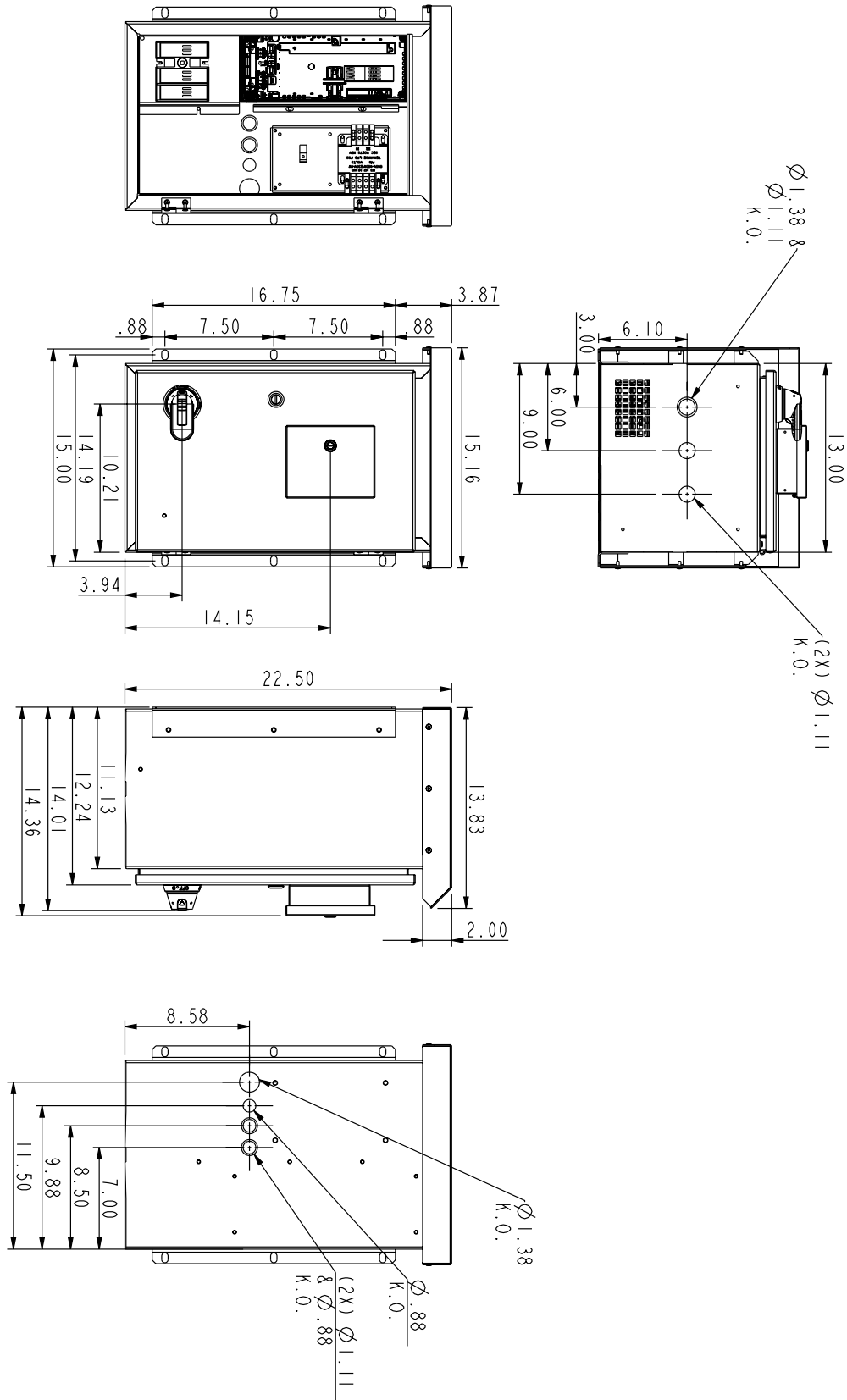

FIGURE 31 - 3R NONBYPASS BOX 1

Dimensions (continued)

Drawing #: 3AXD50000495030

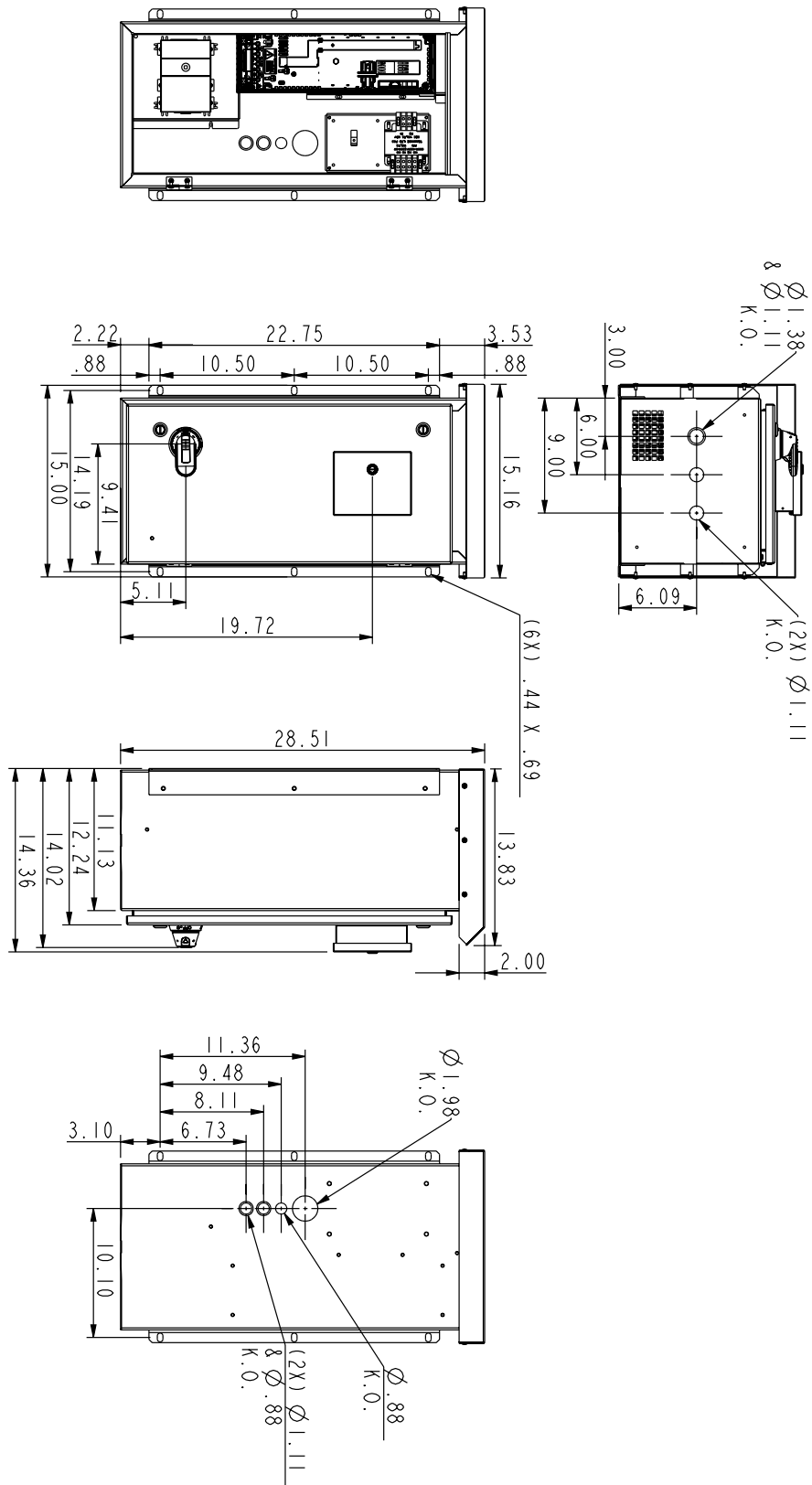

FIGURE 32 - 3R NONBYPASS BOX 2

Dimensions (continued)

Drawing #: 3AXD50000495146

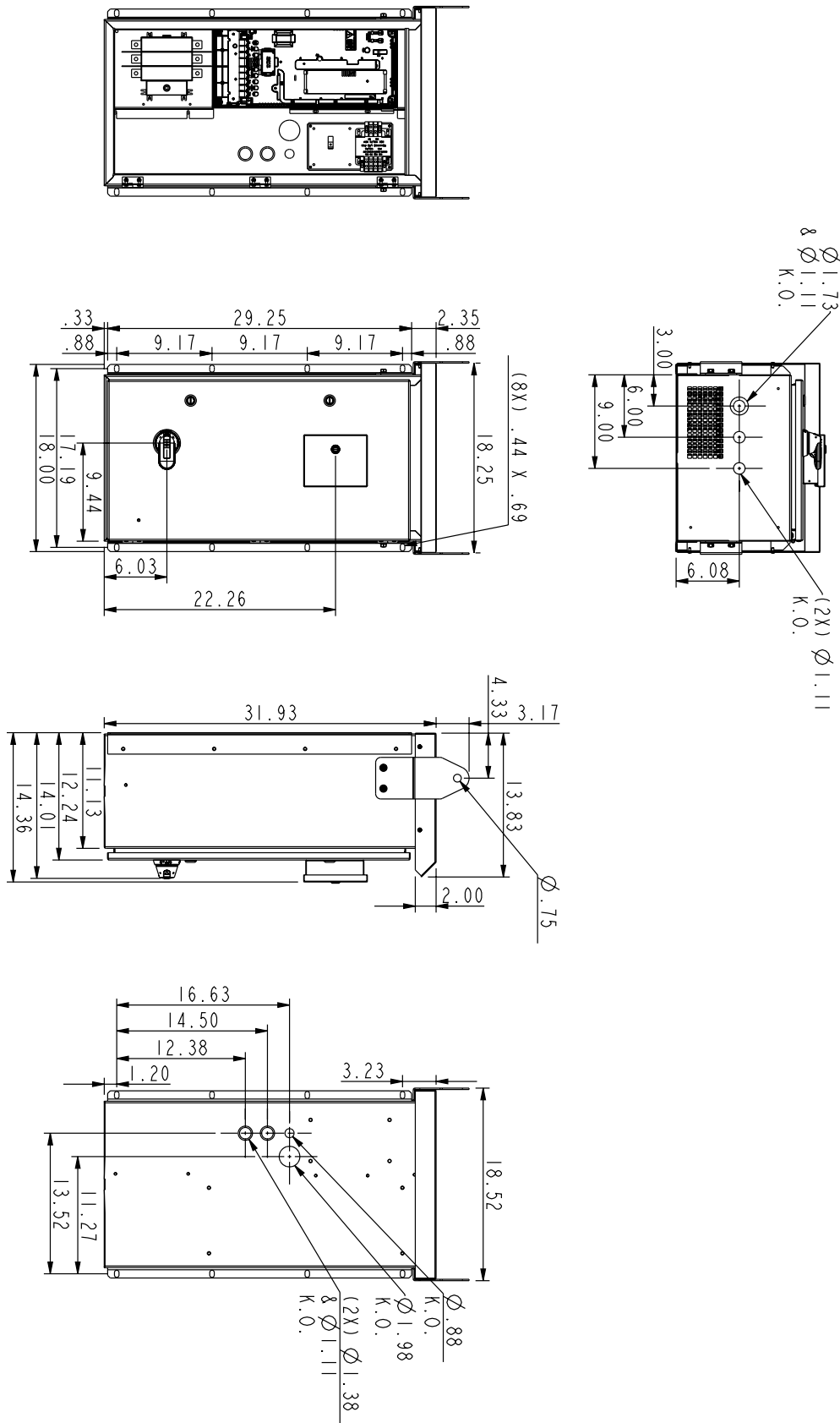

FIGURE 33 - 3R NONBYPASS BOX 3

Dimensions (continued)

Drawing #: 3AXD50000496563

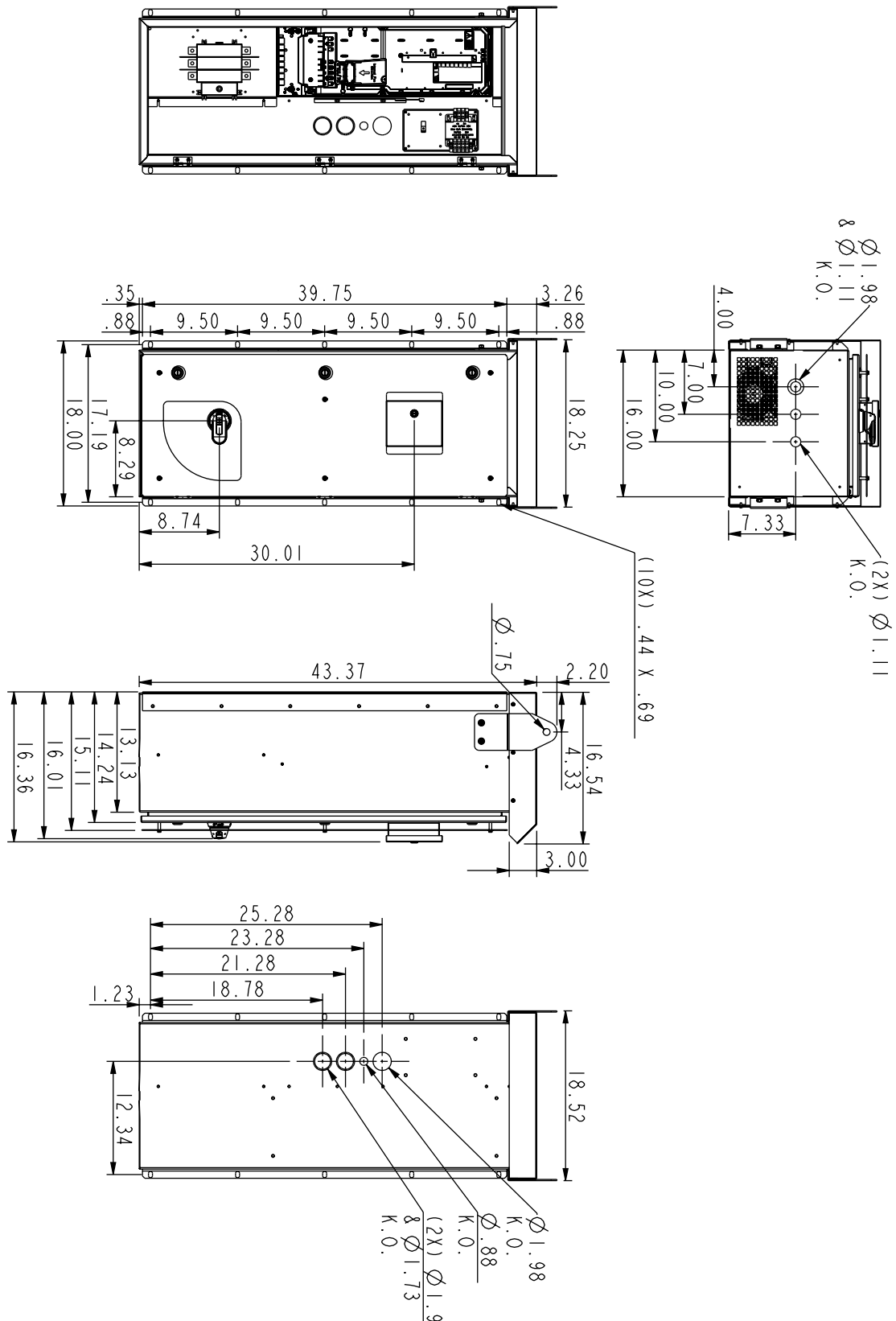

FIGURE 34 - 3R NONBYPASS BOX 4

Dimensions (continued)

Drawing #: 3AXD50000495221

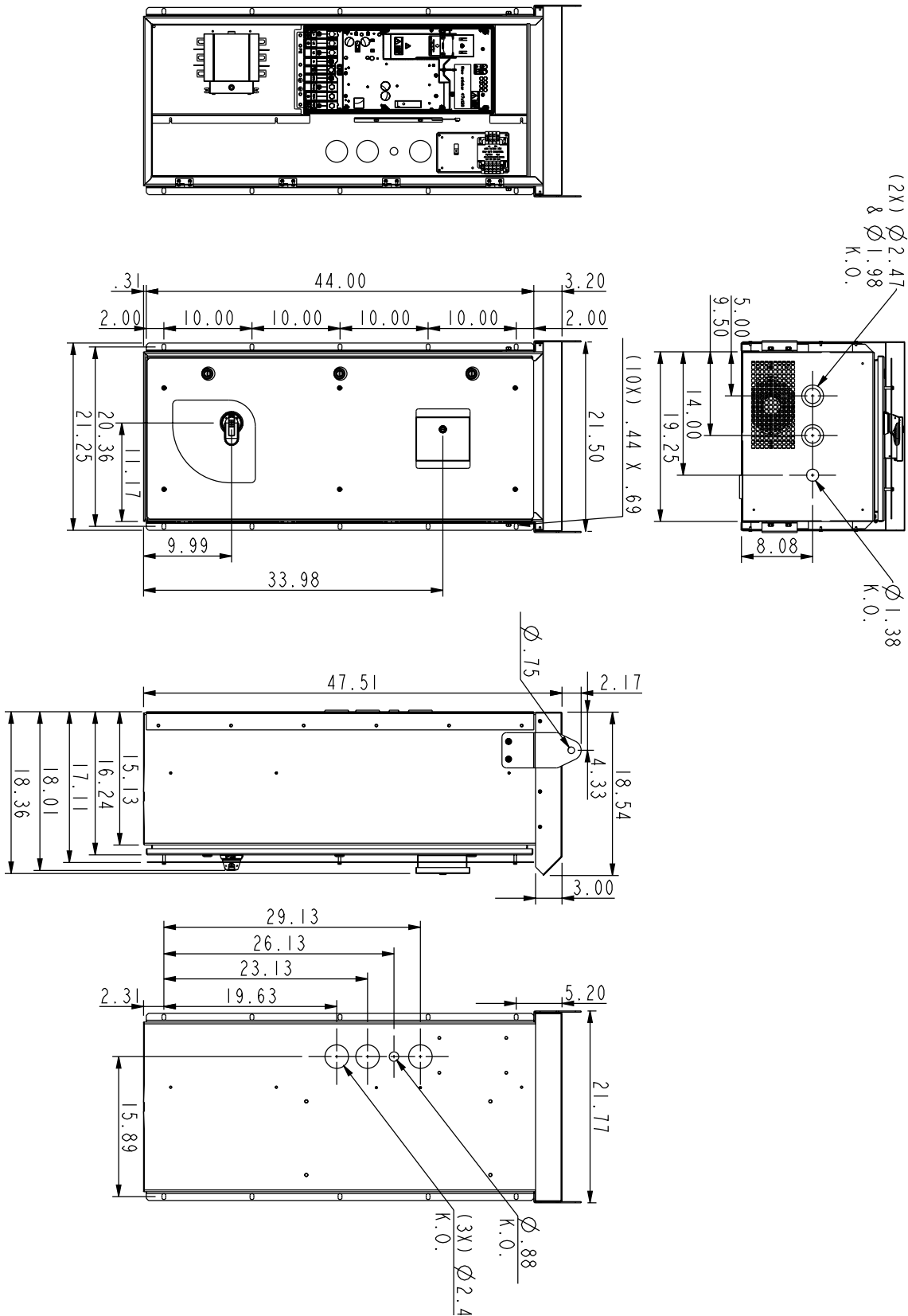

FIGURE 35 - 3R NONBYPASS BOX 5

Dimensions (continued)

Drawing #: 3AXD50000496747

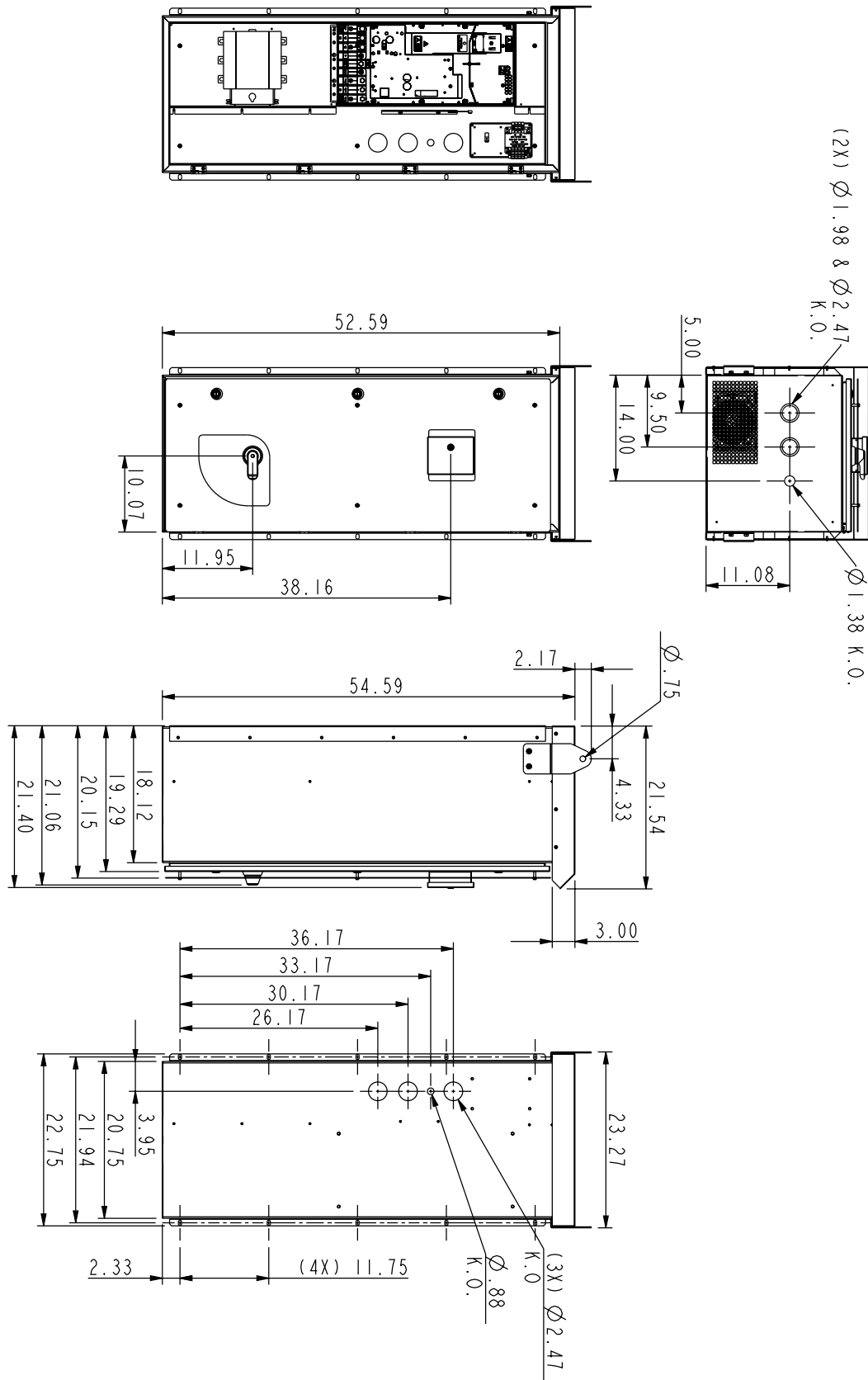

FIGURE 36 - 3R NONBYPASS BOX 6

Dimensions (continued)

Drawing #: 3AXD50000495078

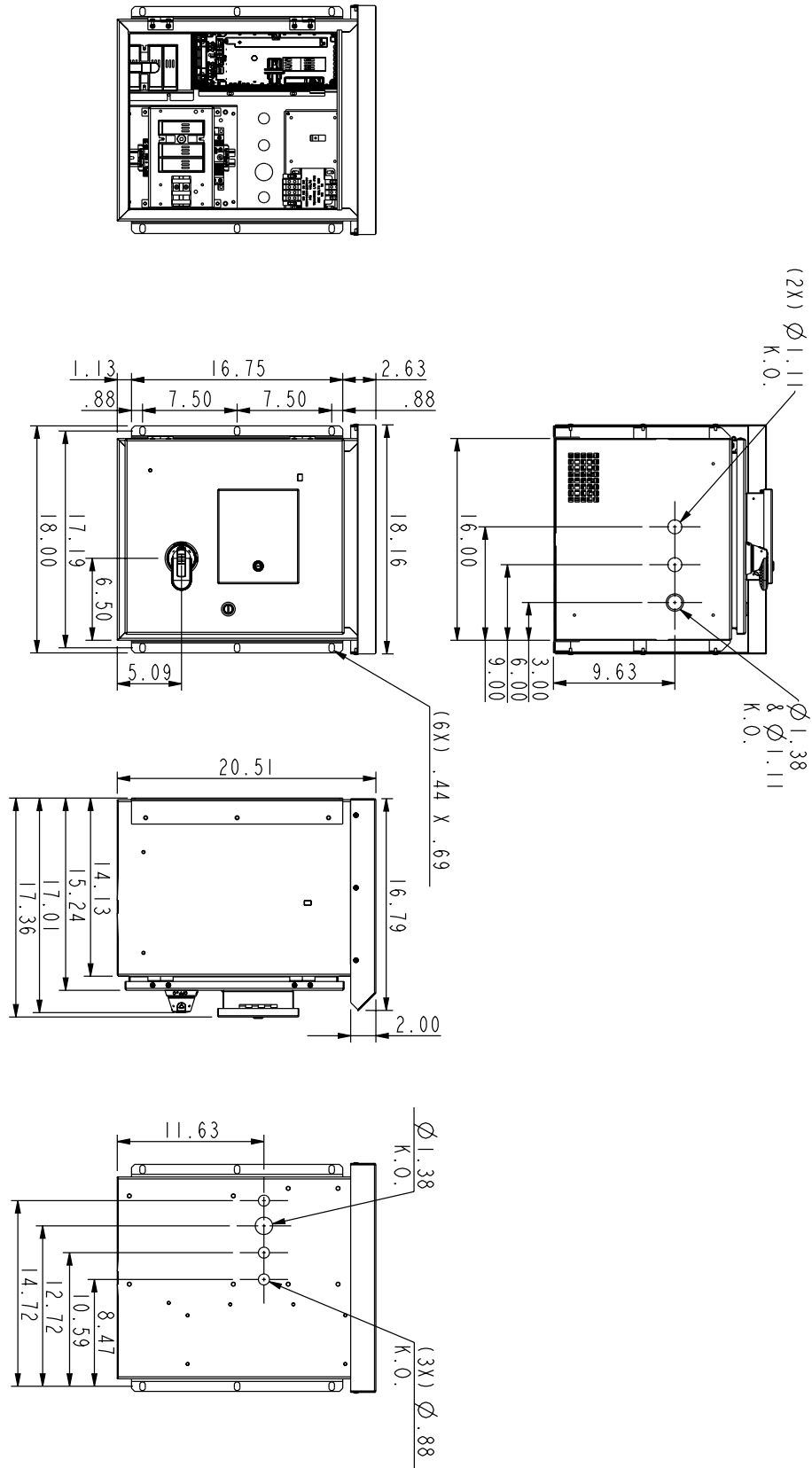
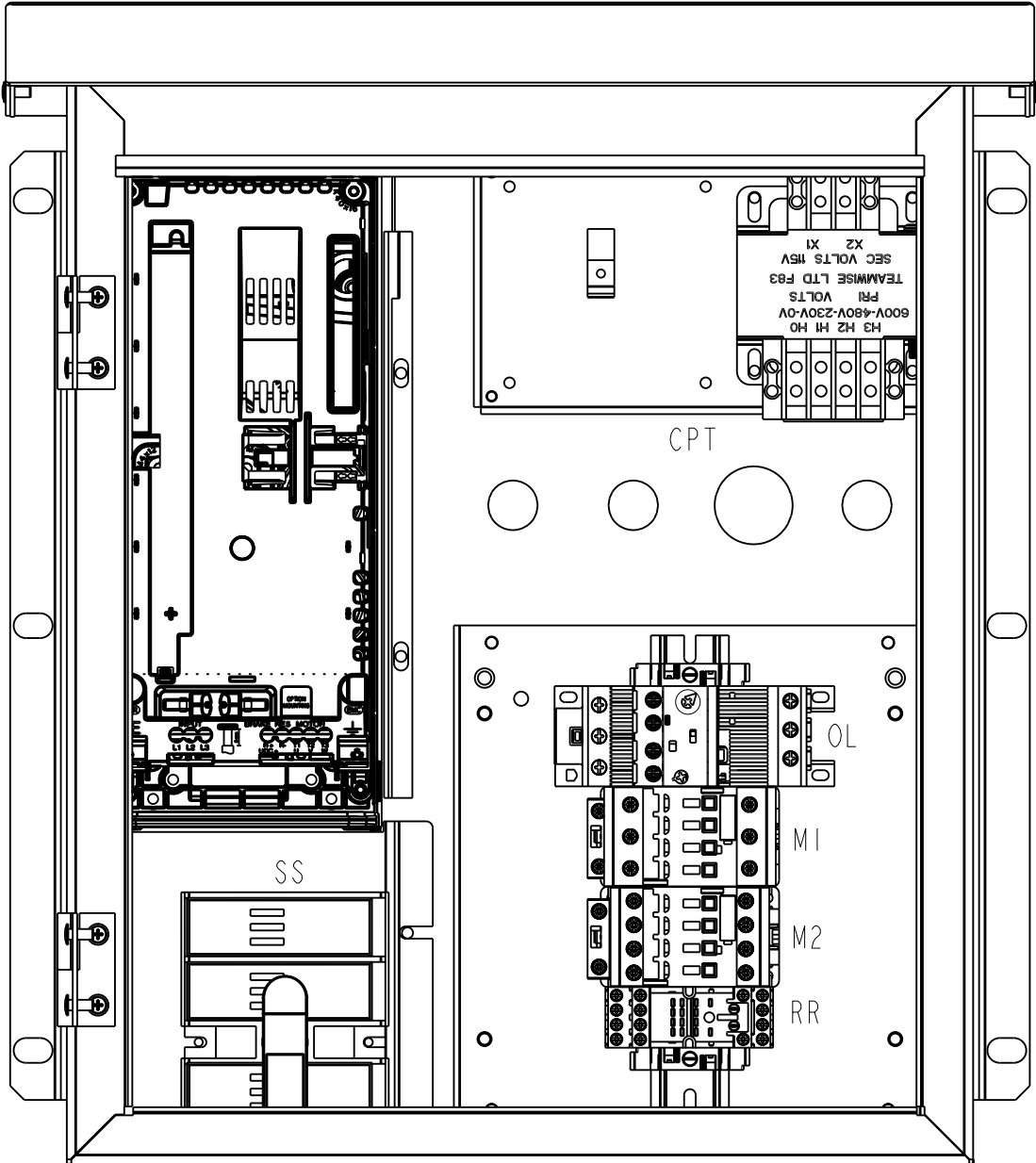

FIGURE 37 - 3R BYPASS BOX 1

Dimensions (continued)

Drawing #: 3AXD50000495078



1:4

FIGURE 37 - 3R BYPASS BOX 1 (CONT'D)

Dimensions (continued)

Drawing #: 3AXD50000495597

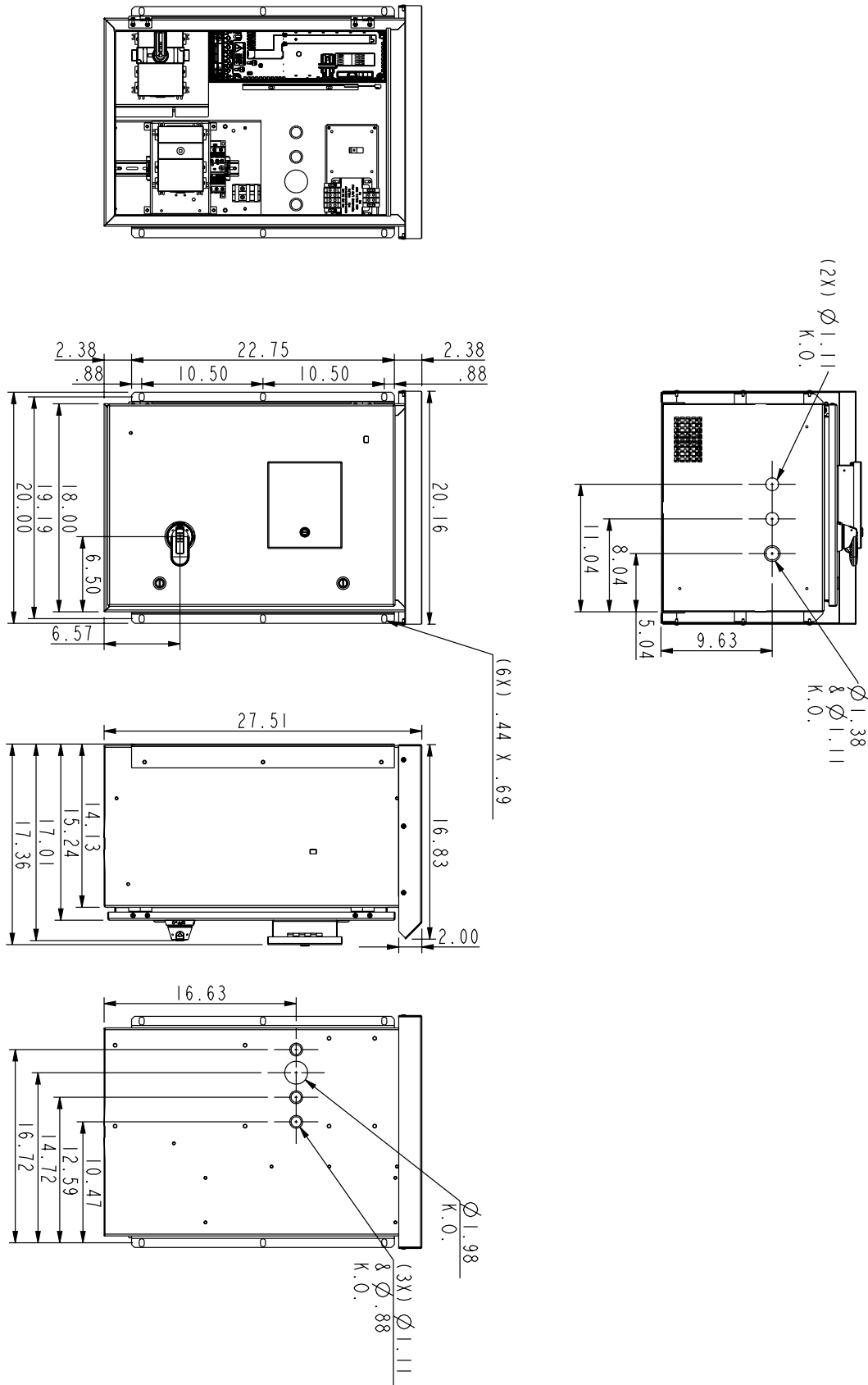

FIGURE 38 - 3R BYPASS BOX 2

Dimensions (continued)

Drawing #: 3AXD50000495597

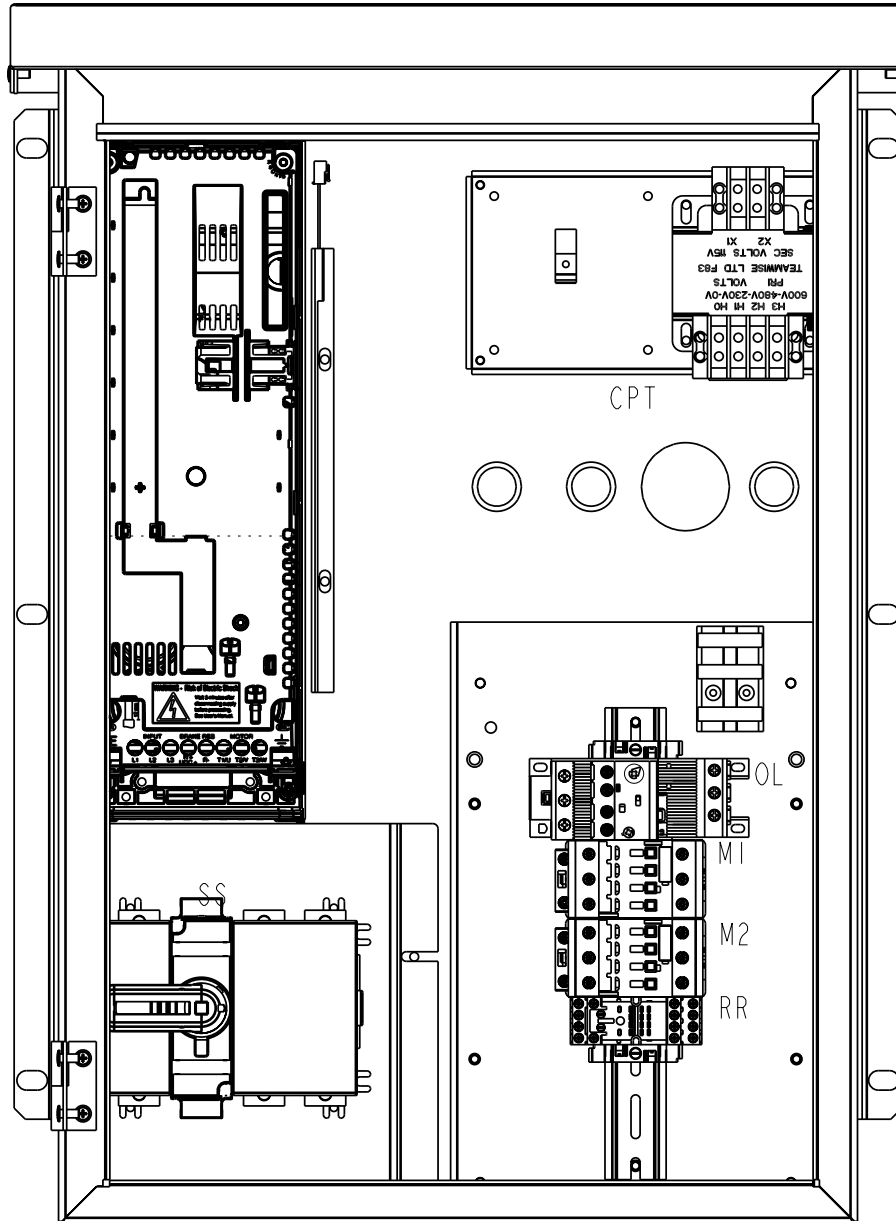

FIGURE 38 -3R BYPASS BOX 2 (CONT'D)

Dimensions (continued)

Drawing #: 3AXD50000496419

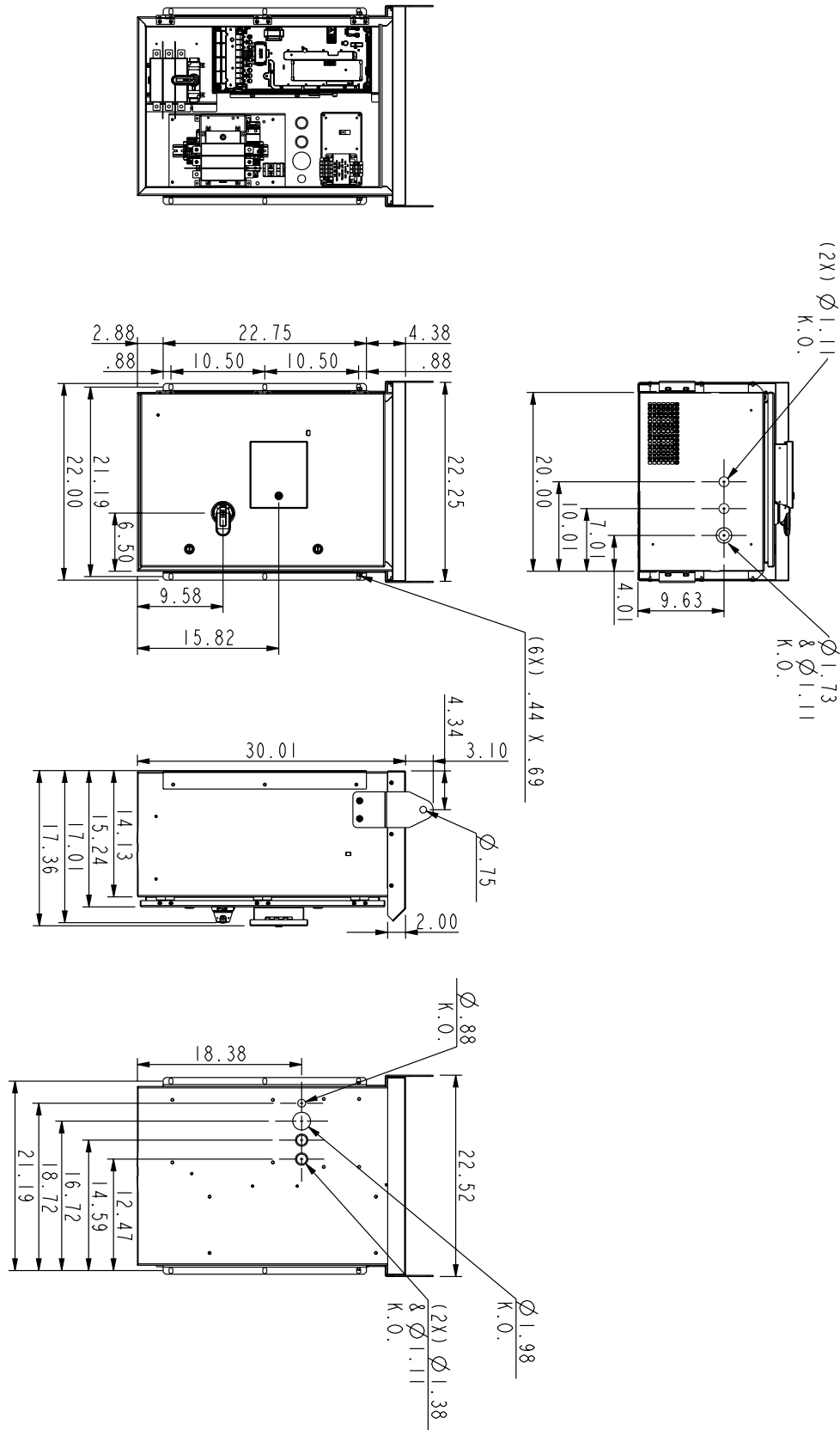

FIGURE 39 - 3R BYPASS BOX 3

Dimensions (continued)

Drawing #: 3AXD50000496419

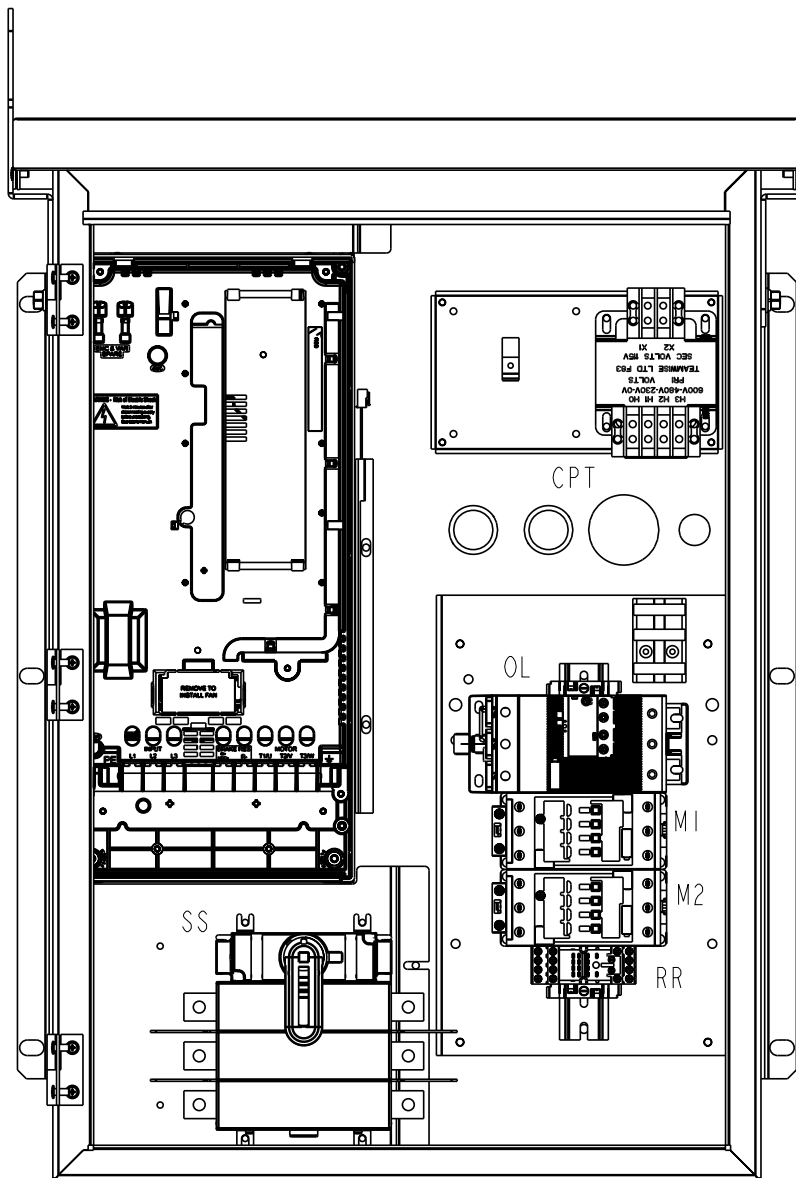

FIGURE 39 -3R BYPASS BOX 3 (CONT'D)

Dimensions (continued)

Drawing #: 3AXD50000496938

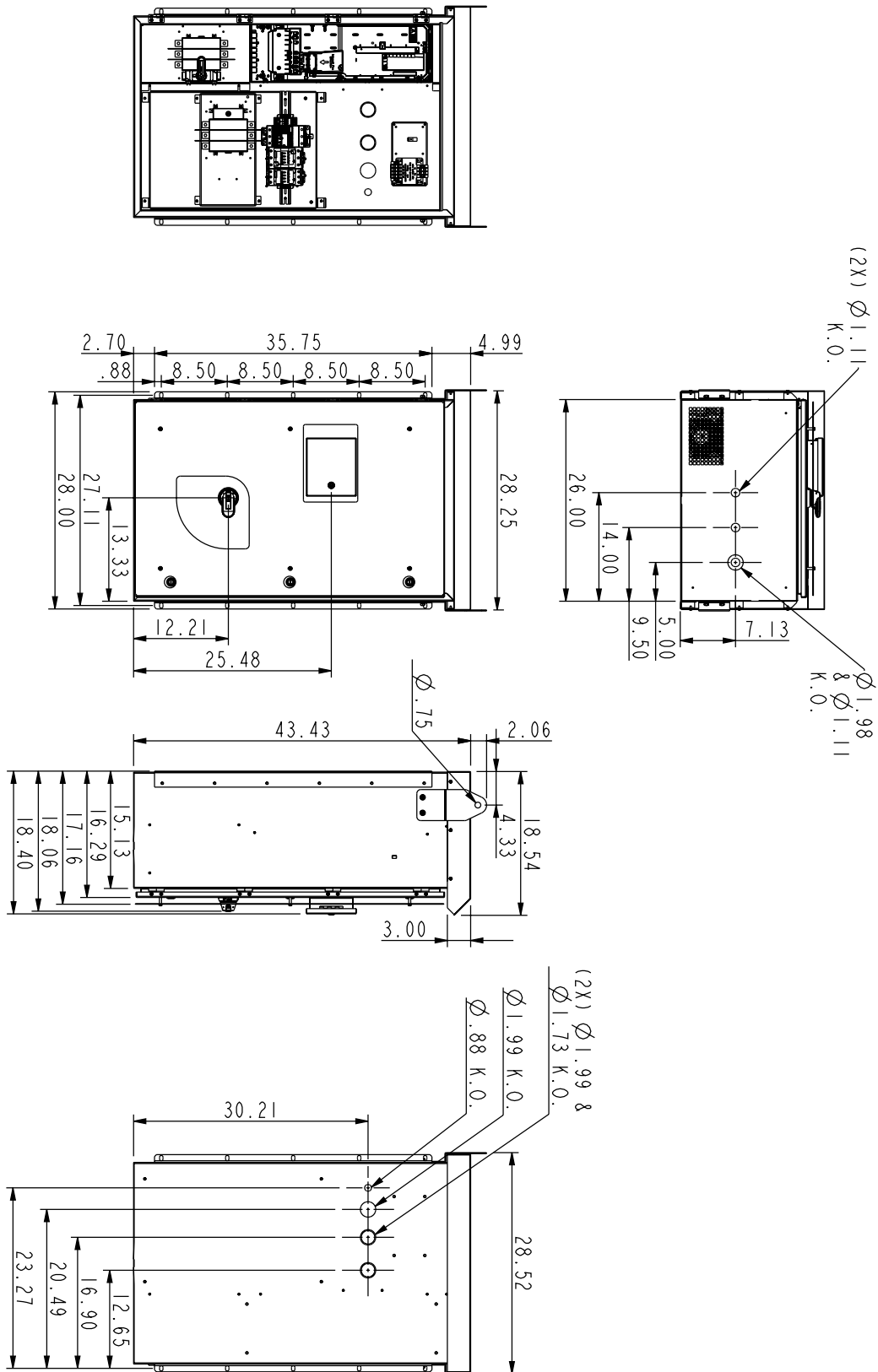

FIGURE 40 - 3R BYPASS BOX 4

Dimensions (continued)

Drawing #: 3AXD50000496938

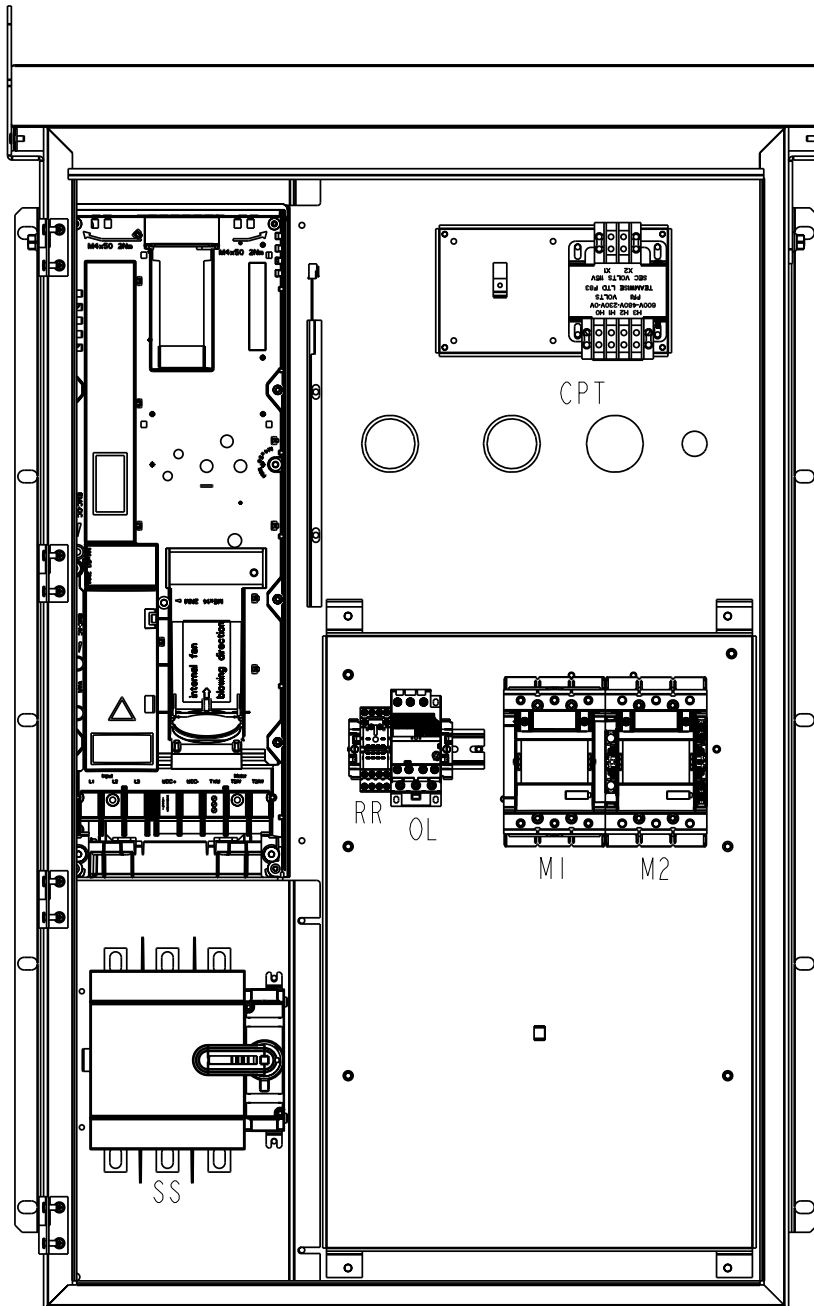

FIGURE 40 -3R BYPASS BOX 4 (CONT'D)

Dimensions (continued)

Drawing #3AXD50000496334

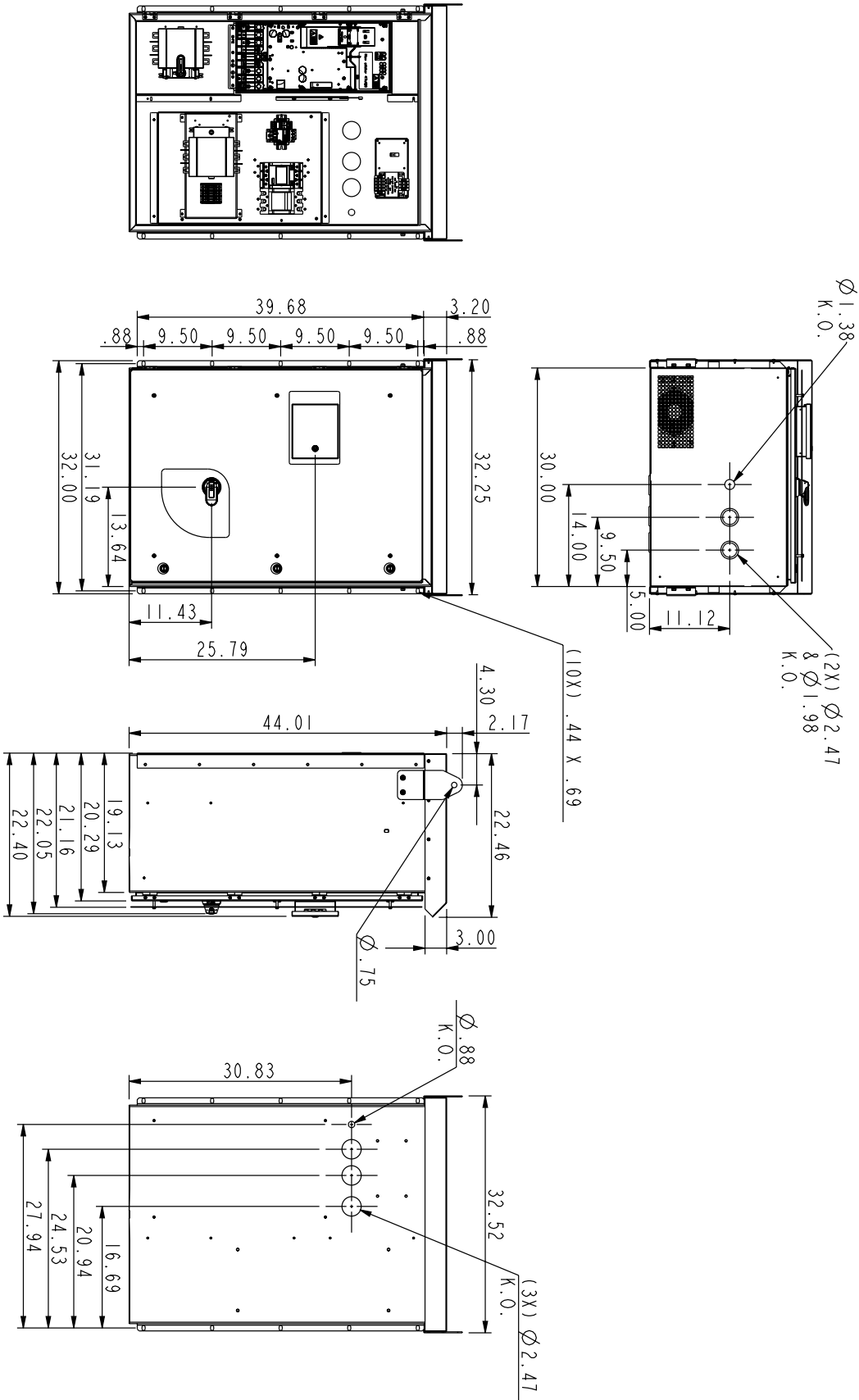

FIGURE 41 - 3R BYPASS BOX 5

Dimensions (continued)

Drawing #3AXD50000496334

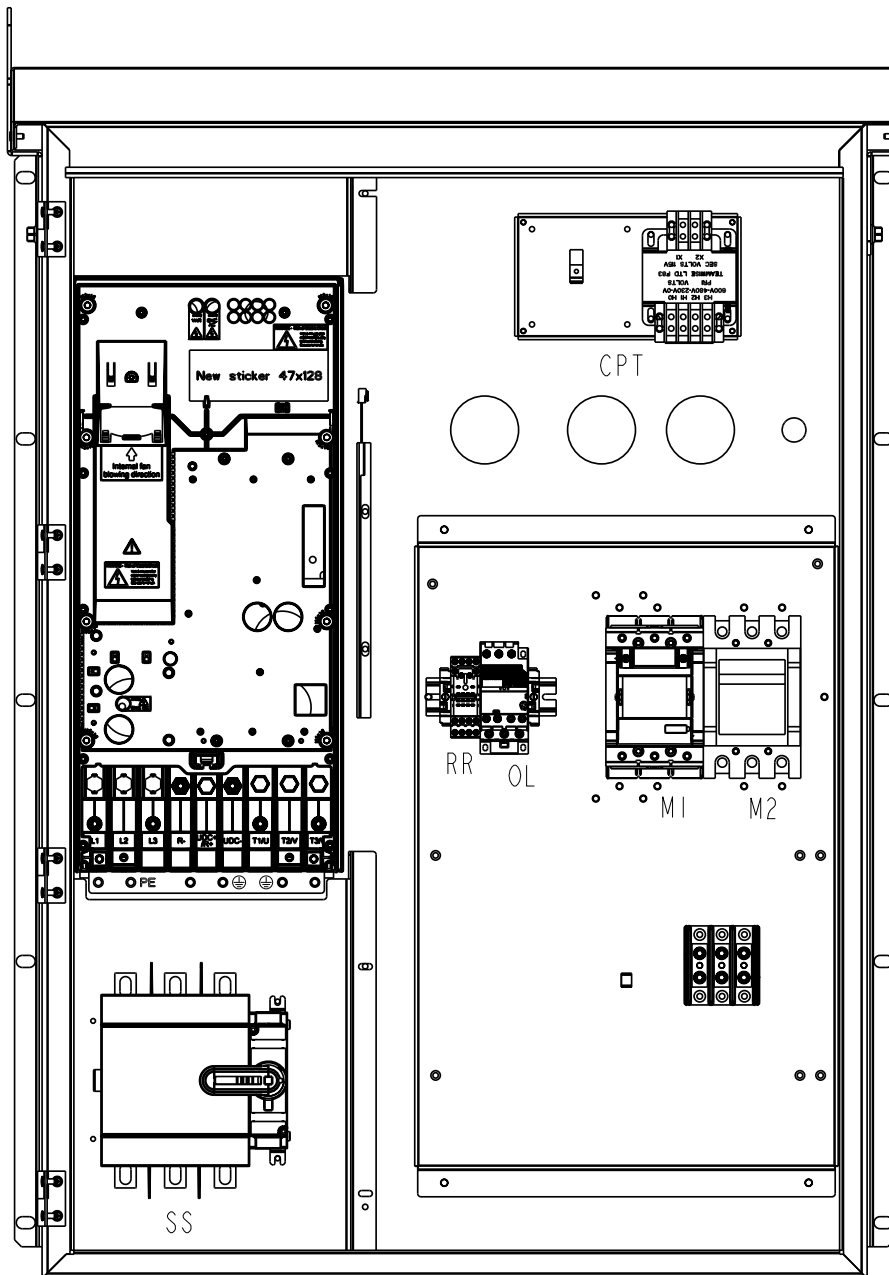

FIGURE 41 -3R BYPASS BOX 5 (CONT'D)

Dimensions (continued)

Drawing #: 3AXD50000499632

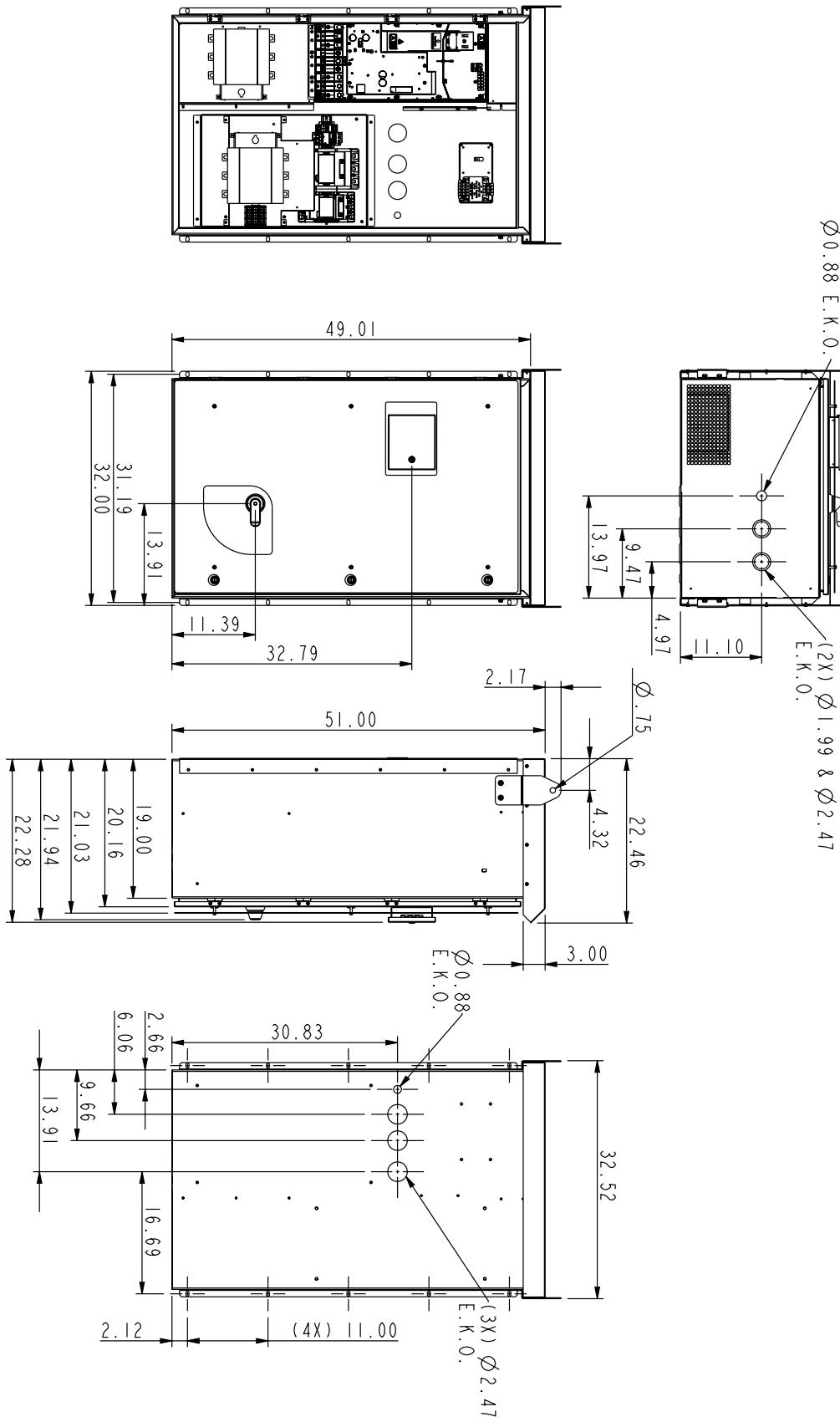

FIGURE 42 - 3R BYPASS BOX 5

Dimensions (continued)

Drawing #: 3AXD50000499632

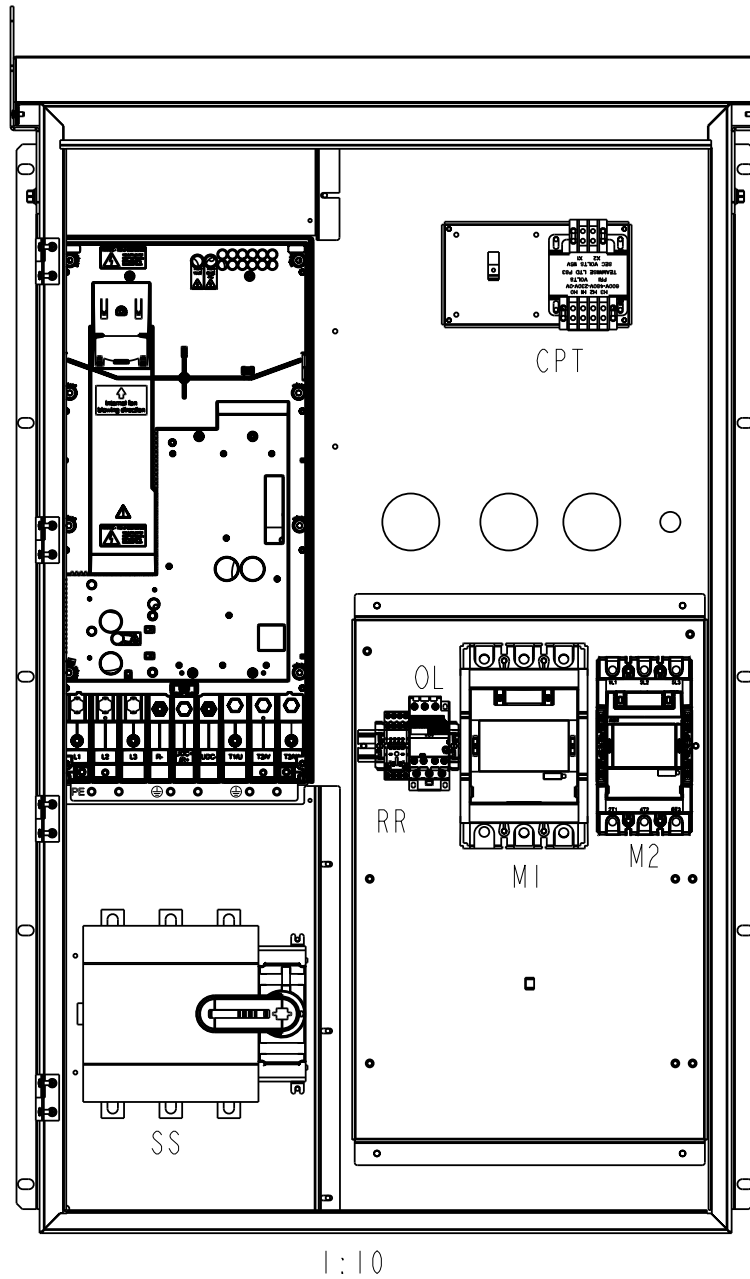

FIGURE 42 -3R BYPASS BOX 5 (CONT'D)

TABLE 7 - PERFORMANCE DATA 200 - 240 VAC

AYK JCI Drive	Special Note: Plus Code +P940 = Base Drive Less Cover and Less Conduit Box / IP20							
ABB Model	AYK 580-01	AYK 580-01	AYK 580-01	AYK 580-01	AYK 580-01	AYK 580-01	AYK 580-01	AYK 580-01
Series	-04A6-2	-06A6-2	-07A5-2	-10A6-2	-017A-2	-024A-2	-031A-2	-046A-2
Motor Horsepower	1	1.5	2	3	5	7.5	10	15
Motor KW	0.7	1.1	1.5	2.2	3.7	5.6	7.5	11.2
Frame Size	R1	R1	R1	R1	R1	R2	R2	R3
Output Current Amps @ 40°C	4.6	6.6	7.5	10.6	16.7	24.8	30.8	46.2
Overload Current Rating	110% for 1 minute every 10 minutes							
Max Output Voltage	3 Phase 0 volts up to input voltage max.							
Rated Input Voltage	3 Phase 208/240 VAC +10%/-15% 48/63Hz +/- 3%							
Rated Input Current Amps @ 40°C (Use on Unit ID Nameplate)	4.6	6.6	7.5	10.6	16.7	24	30.8	46.2
Recommended Class T Fuse Size (Amps)	15	15	15	15	30	40	40	80
Maximum Power Cable Size AWG	10	10	10	10	10	6	6	2
Heat Loss in watts 100 % load	45	55	66	84	133	174	228	322
Efficiency (%) min.	Approximately 98% at nominal load							
Environment								
Ambient Temperature	-15 to +50 °C (5 to 122 °F): No frost allowed / Output derated above +40 °C (104 °F)							
Storage Temperature	-40°C to 70°C -40 - 158° F							
Humidity	5 to 95% No condensation allowed Maximum relative humidity is 60% in the presence of corrosive gasses							
Altitude	MAX 3,300 feet without de-rate. 1% derate for each 330 feet above 3,300 up to 6,600' / Above 6,600' Contact Tech Support for additional derating (Max Altitude to 13,123' with Derate)							
Enclosure	Nema 1 Fan Cooled / with Conduit Box Included as Standard							
Weight kg approximate	4.60	4.60	4.60	4.60	4.60	6.60	6.60	11.80
Weight Lbs approximate	10.10	10.10	10.10	10.10	10.10	14.60	14.60	26.00
Input Frequency	48-63 Hz							
Imbalance	maximum +/- 3% of nominal phase to phase input voltage							
Fundamental Power Factor (cos phi)	0.98 at nominal load							
Frequency Resolution	0.01Hz							
Maximum motor cable length	100 M (R1); 200 M (R2); 300 M (R3-R9) max without output filterers							
Heat Loss in BTU/Hr 100 % load	155	187	224	288	454	593	777	1100
Air Flow m3/h	43	43	43	43	43	101	101	179
Air Flow ft3/min	25	25	25	25	25	59	59	105
Sinusoidal Vibration (IEC 60068-2-6)	Mechanical conditions: IEC 60068-2 , 2....13.2Hz 1mm (0.04in) , 13.2...100Hz 7m/s2 (23 ft/s2)							
Output Current Derating								
Temperature 1% per degree C above 40°C IE: 50°C=output* 0.90	-15 to +50 °C (5 to 122 °F): No frost allowed / Output derated above +40 °C (104 °F)							
Altitude: 1% of output for every 330 feet above 3,300 feet	MAX 3,300 feet without de-rate. 1% derate for each 330 feet above 3,300 up to 6,600' / Above 6,600' Contact Tech Support for additional derating (Max Altitude to 13,123' with Derate)							
Single Phase supply for 208-240v drives derate output by 50%	Rule of THUMB for Single Phase supply for 208-240v drives derate output by 50% / Need Actual 3Phase Motor Data to Determine Drive Size / Also Refer to User Manual for any additional concerns it any							
Switching Frequency: 2, 4, 8 or 12 kHz See User Manual for Derate	Switching Frequency: 2, 4, 8 or 12 kHz Please see User Manual for Proper Derates at Carrier Frequencies above 4KHz. / Automatic fold back in case of overload							

Single phase 208-240 VAC input available on base drive only. Output will be at 3 phase to motor. Bypass will not work on single phase input. Consult Johnson Controls Marketing for single phase applications
Do not use aluminium cable with frame sizes R1...R4

Performance Data (continued)

TABLE 17 - PERFORMANCE DATA 200 - 240 VAC (CONT'D)

AYK JCI Drive	Special Note: Plus Code +P940 = Base Drive Less Cover and Less Conduit Box / IP20							
ABB Model	AYK 580-01	AYK 580-01	AYK 580-01	AYK 580-01	AYK 580-01	AYK 580-01	AYK 580-01	AYK 580-01
Series	-059A-2	-075A-2	-088A-2	-114A-2	-143A-2	-169A-2	-211A-2	-273A-2
Motor Horsepower	20	25	30	40	50	60	75	100
Motor KW	14.9	18.6	22.4	29.8	37.3	44.7	55.9	74.6
Frame Size	R3	R4	R5	R5	R6	R7	R7	R8
Output Current Amps @ 40°C	59.4	74.8	88	114	143	169	211	273
Overload Current Rating	110% for 1 minute every 10 minutes							
Max Output Voltage	3 Phase 0 volts up to input voltage max.							
Rated Input Voltage	3 Phase 208/240 VAC +10%/-15% 48/63Hz +/- 3%							
Rated Input Current Amps @ 40°C (Use on Unit ID Nameplate)	59.4	74.8	88	114	143	169	211	273
Recommended Class T Fuse Size (Amps)	80	100	150	150	200	250	300	400
Maximum Power Cable Size AWG	2	1	2/0	2/0	300MCM	500MCM	500MCM	(2)300MCM
Heat Loss in watts 100 % load	430	525	619	835	1035	1251	1251	2061
Efficiency (%) min.	Approximately 98% at nominal load							
Environment								
Ambient Temperature	-15 to +50 °C (5 to 122 °F): No frost allowed / Output derated above +40 °C (104 °F)							
Storage Temperature	-40°C to 70°C -40 - 158' F							
Humidity	5 to 95% No condensation allowed Maximum relative humidity is 60% in the presence of corrosive gasses							
Altitude	MAX 3,300 feet without de-rate. 1% derate for each 330 feet above 3,300 up to 6,600' / Above 6,600' Contact Tech Support for additional derating (Max Altitude to 13,123' with Derate)							
Enclosure	Nema 1 Fan Cooled / with Conduit Box Included as Standard							
Weight kg approximate	11.80	19.00	28.30	28.30	42.40	54.00	54.00	69.00
Weight Lbs approximate	26.00	41.90	62.40	62.40	93.50	119.10	119.10	152.20
Input Frequency	48-63 Hz							
Imbalance	maximum +/- 3% of nominal phase to phase input voltage							
Fundamental Power Factor (cos phi)	0.98 at nominal load							
Frequency Resolution	0.01Hz							
Maximum motor cable length	100 M (R1); 200 M (R2); 300 M (R3-R9) max without output fitters							
Heat Loss in BTU/Hr 100 % load	1469	1791	2114	2852	3535	4272	5194	7039
Air Flow m3/h	179	288	139	139	435	450	450	550
Air Flow ft3/min	105	170	82	82	256	265	265	324
Sinusoidal Vibration (IEC 60068-2-6)	Mechanical conditions: IEC 60068-2 , 2....13.2Hz 1mm (0.04in) , 13.2...100Hz 7m/s2 (23 ft/s2)							
Output Current Derating								
Temperature 1% per degree C above 40°C IE: 50°C=output* 0.90	-15 to +50 °C (5 to 122 °F): No frost allowed / Output derated above +40 °C (104 °F)							
Altitude: 1% of output for every 330 feet above 3,300 feet	MAX 3,300 feet without de-rate. 1% derate for each 330 feet above 3,300 up to 6,600' / Above 6,600' Contact Tech Support for additional derating (Max Altitude to 13,123' with Derate)							
Single Phase supply for 208-240v drives derate output by 50%	Rule of THUMB for Single Phase supply for 208-240v drives derate output by 50% / Need Actual 3Phase Motor Data to Determine Drive Size / Also Refer to User Manual for any additional concerns it any							
Switching Frequency: 2, 4, 8 or 12 kHz See User Manual for Derate	Switching Frequency: 2, 4, 8 or 12 kHz Please see User Manual for Proper Derates at Carrier Frequencies above 4KHz. / Automatic fold back in case of overload							

Single phase 208-240 VAC input available on base drive only. Output will be at 3 phase to motor. Bypass will not work on single phase input. Consult Johnson Controls Marketing for single phase applications
Do not use aluminium cable with drame sizes R1...R4

Performance Data (continued)

FORM 100.42-EG1 (920)

TABLE 8 - PERFORMANCE DATA 380-480 VAC

AYK JCI Drive	Special Note: Plus Code +P940 = Base Drive Less Cover and Less Conduit Box / IP20							
ABB Model	AYK 580-01	AYK 580-01	AYK 580-01	AYK 580-01	AYK 580-01	AYK 580-01	AYK 580-01	AYK 580-01
Series	-02A1-4	-03A0-4	-03A5-4	-04A8-4	-07A6-4	-012A-4	-014A-4	-023A-4
Motor Horsepower	1	1.5	2	3	5	7.5	10	15
Motor KW	0.7	1.1	1.5	2.2	3.7	5.6	7.5	11.2
Frame Size	R1	R1	R1	R1	R1	R1	R2	R2
Output Current Amps @ 40°C	2.1	3	3.5	4.8	7.6	12	14	23
Overload Current Rating	110% for 1 minute every 10 minutes							
Max Output Voltage	3 Phase 0 volts up to input voltage max.							
Rated Input Voltage	380/400/415/440/460/480 +10% -15% VAC 3 phase 48/63Hz +/- 3%							
Rated Input Current Amps @ 40°C (Use on Unit ID Nameplate)	2.1	3	3.5	4.8	7.6	12	14	23
Recommended Class T Fuse Size (Amps)	15	15	15	15	15	15	30	30
Maximum Power Cable Size AWG	10	10	10	10	10	10	6	6
Heat Loss in watts 100 % load	45	55	66	84	133	174	228	322
Efficiency (%) min.	Approximately 98% at nominal load							
Environment								
Ambient Temperature	-15 to +50 °C (5 to 122 °F): No frost allowed / Output derated above +40 °C (104 °F)							
Storage Temperature	-40°C to 70°C -40 - 158° F							
Humidity	5 to 95% No condensation allowed Maximum relative humidity is 60% in the presence of corrosive gasses							
Altitude	MAX 3,300 feet without de-rate. 1% derate for each 330 feet above 3,300 up to 6,600' / Above 6,600' Contact Tech Support for additional derating (Max Altitude to 13,123' with Derate)							
Enclosure	Nema 1 Fan Cooled / with Conduit Box Included as Standard							
Weight kg approximate	4.60	4.60	4.60	4.60	4.60	4.60	6.60	6.60
Weight Lbs approximate	10.10	10.10	10.10	10.10	10.10	10.10	14.60	14.60
Input Frequency	48-63 Hz							
Imbalance	maximum +/- 3% of nominal phase to phase input voltage							
Fundamental Power Factor (cos phi)	0.98 at nominal load							
Frequency Resolution	0.01Hz							
Maximum motor cable length	100 M (R1); 200 M (R2); 300 M (R3-R9) max without output filters							
Heat Loss in BTU/Hr 100 % load	155	187	224	288	454	593	777	1100
Air Flow m3/h	43	43	43	43	43	43	101	101
Air Flow ft3/min	25	25	25	25	25	25	59	59
Sinusoidal Vibration (IEC 60068-2-6)	Mechanical conditions: IEC 60068-2 , 2....13.2Hz 1mm (0.04in) , 13.2...100Hz 7m/s2 (23 ft/s2)							
Output Current Derating								
Temperature 1% per degree C above 40°C IE: 50°C=output* 0.90	-15 to +50 °C (5 to 122 °F): No frost allowed / Output derated above +40 °C (104 °F)							
Altitude: 1% of output for every 330 feet above 3,300 feet	MAX 3,300 feet without de-rate. 1% derate for each 330 feet above 3,300 up to 6,600' / Above 6,600' Contact Tech Support for additional derating (Max Altitude to 13,123' with Derate)							
Switching Frequency: 2, 4, 8 or 12 kHz. See User Manual for Derate	Switching Frequency: 2, 4, 8 or 12 kHz Please see User Manual for Proper Derates at Carrier Frequencies above 4KHz. / Automatic fold back in case of overload							

1% derate for each 330 feet above 3,300

Performance Data (continued)

FORM 100.42-EG1 (920)

TABLE 8 - PERFORMANCE DATA 380-480 VAC (CONT'D)

AYK JCI Drive	Special Note: Plus Code +P940 = Base Drive Less Cover and Less Conduit Box / IP20							
ABB Model	AYK 580-01	AYK 580-01	AYK 580-01	AYK 580-01	AYK 580-01	AYK 580-01	AYK 580-01	AYK 580-01
Series	-027A-4	-034A-4	-044A-4	-052A-4	-065A-4	-077A-4	-096A-4	-124A-4
Motor Horsepower	20	25	30	40	50	60	75	100
Motor KW	14.9	18.6	22.4	29.8	37.3	44.7	55.9	74.6
Frame Size	R3	R3	R3	R4	R4	R4	R5	R6
Output Current Amps @ 40°C	27	34	44	52	65	77	96	124
Overload Current Rating	110% for 1 minute every 10 minutes							
Max Output Voltage	3 Phase 0 volts up to input voltage max.							
Rated Input Voltage	380/400/415/440/460/480 +10% -15% VAC 3 phase 48/63Hz +/- 3%							
Rated Input Current Amps @ 40°C (Use on Unit ID Nameplate)	27	34	44	52	62	77	106	124
Recommended Class T Fuse Size (Amps)	40	60	60	80	100	100	150	200
Maximum Power Cable Size AWG	2	2	2	1	1	1	2/0	300MCM
Heat Loss in watts 100 % load	430	525	619	835	1024	1240	1510	1476
Efficiency (%) min.	Approximately 98% at nominal load							
Environment								
Ambient Temperature	-15 to +50 °C (5 to 122 °F): No frost allowed / Output derated above +40 °C (104 °F)							
Storage Temperature	-40°C to 70°C -40 - 158' F							
Humidity	5 to 95% No condensation allowed Maximum relative humidity is 60% in the presence of corrosive gasses							
Altitude	MAX 3,300 feet without de-rate. 1% derate for each 330 feet above 3,300 up to 6,600' / Above 6,600' Contact Tech Support for additional derating (Max Altitude to 13,123' with Derate)							
Enclosure	Nema 1 Fan Cooled / with Conduit Box Included as Standard							
Weight kg approximate	11.80	11.80	11.80	19.00	19.00	19.00	28.30	42.40
Weight Lbs approximate	26.00	26.00	26.00	41.90	41.90	41.90	62.40	93.50
Input Frequency	48-63 Hz							
Imbalance	maximum +/- 3% of nominal phase to phase input voltage							
Fundamental Power Factor (cos phi)	0.98 at nominal load							
Frequency Resolution	0.01Hz							
Maximum motor cable length	100 M (R1); 200 M (R2); 300 M (R3-R9) max without output filter							
Heat Loss in BTU/Hr 100 % load	1469	1791	2114	2852	3497	4235	5157	5041
Air Flow m3/h	179	179	179	134	134	288	139	435
Air Flow ft3/min	105	105	105	79	79	79	82	256
Sinusoidal Vibration (IEC 60068-2-6)	Mechanical conditions: IEC 60068-2 , 2....13.2Hz 1mm (0.04in) , 13.2...100Hz 7m/s2 (23 ft/s2)							
Output Current Derating								
Temperature 1% per degree C above 40°C IE: 50°C=output* 0.90	-15 to +50 °C (5 to 122 °F): No frost allowed / Output derated above +40 °C (104 °F)							
Altitude: 1% of output for every 330 feet above 3,300 feet	MAX 3,300 feet without de-rate. 1% derate for each 330 feet above 3,300 up to 6,600' / Above 6,600' Contact Tech Support for additional derating (Max Altitude to 13,123' with Derate)							
Switching Frequency: 2, 4, 8 or 12 kHz. See User Manual for Derate	Switching Frequency: 2, 4, 8 or 12 kHz Please see User Manual for Proper Derates at Carrier Frequencies above 4KHz. / Automatic fold back in case of overload							

1% derate for each 330 feet above 3,300

Performance Data (continued)

TABLE 8 - PERFORMANCE DATA 380-480 VAC (CONT'D)

AYK JCI Drive	Special Note: Plus Code +P940 = Base Drive Less Cover and Less Conduit Box / IP20					
ABB Model	AYK 580-01	AYK 580-01	AYK 580-01	AYK 580-01	AYK 580-01	AYK 580-01
Series	-156A-4	-180A-4	-240A-4	-302A-4	-361A-4	-414A-4
Motor Horsepower	125	150	200	250	300	350
Motor KW	93.2	111.9	149.1	186.4	223.7	261.0
Frame Size	R7	R7	R8	R9	R9	R9
Output Current Amps @ 40°C	156	180	240	302	361	414
Overload Current Rating	110% for 1 minute every 10 minutes					
Max Output Voltage	3 Phase 0 volts up to input voltage max.					
Rated Input Voltage	380/400/415/440/460/480 +10% -15% VAC 3 phase 48/63Hz +/- 3%					
Rated Input Current Amps @ 40°C (Use on Unit ID Nameplate)	156	180	240	302	361	414
Recommended Class T Fuse Size (Amps)	225	300	350	500	500	600
Maximum Power Cable Size AWG	500MCM	500MCM	(2) 300MCM	(2) 500MCM	(2) 500MCM	(2) 500MCM
Heat Loss in watts 100 % load	1976	2346	3336	4836	4836	6036
Efficiency (%) min.	Approximately 98% at nominal load					
Environment						
Ambient Temperature	-15 to +50 °C (5 to 122 °F): No frost allowed / Output derated above +40 °C (104 °F)					
Storage Temperature	-40°C to 70°C -40 - 158' F					
Humidity	5 to 95% No condensation allowed Maximum relative humidity is 60% in the presence of corrosive gasses					
Altitude	MAX 3,300 feet without de-rate. 1% derate for each 330 feet above 3,300 up to 6,600' / Above 6,600' Contact Tech Support for additional derating (Max Altitude to 13,123' with Derate)					
Enclosure	Nema 1 Fan Cooled / with Conduit Box Included as Standard					
Weight kg approximate	54.00	54.00	69.00	97.00	97.00	97.00
Weight Lbs approximate	119.10	119.10	152.20	213.90	213.90	213.90
Input Frequency	48-63 Hz					
Imbalance	maximum +/- 3% of nominal phase to phase input voltage					
Fundamental Power Factor (cos phi)	0.98 at nominal load					
Frequency Resolution	0.01Hz					
Maximum motor cable length	100 M (R1); 200 M (R2); 300 M (R3-R9) max without output filterers					
Heat Loss in BTU/Hr 100 % load	6748	8012	11393	16516	16515	20614
Air Flow m3/h	450	450	550	1150	1150	1150
Air Flow ft3/min	265	265	324	324	677	677
Sinusoidal Vibration (IEC 60068-2-6)	Mechanical conditions: IEC 60068-2 , 2...13.2Hz 1mm (0.04in) , 13.2...100Hz 7m/s ² (23 ft/s ²)					
Output Current Derating						
Temperature 1% per degree C above 40°C IE: 50°C=output* 0.90	-15 to +50 °C (5 to 122 °F): No frost allowed / Output derated above +40 °C (104 °F)					
Altitude: 1% of output for every 330 feet above 3,300 feet	MAX 3,300 feet without de-rate. 1% derate for each 330 feet above 3,300 up to 6,600' / Above 6,600' Contact Tech Support for additional derating (Max Altitude to 13,123' with Derate)					
Switching Frequency: 2, 4, 8 or 12 kHz. See User Manual for Derate	Switching Frequency: 2, 4, 8 or 12 kHz Please see User Manual for Proper Derates at Carrier Frequencies above 4KHz. / Automatic fold back in case of overload					

1% derate for each 330 feet above 3,300

Performance Data (continued)

TABLE 9 - PERFORMANCE DATA 50-600 VAC

AYK JCI Drive	Special Note: Plus Code +P940 = Base Drive Less Cover and Less Conduit Box / IP20							
ABB Model	AYK 580-01	AYK 580-01	AYK 580-01	AYK 580-01	AYK 580-01	AYK 580-01	AYK 580-01	AYK 580-01
Series	-02A7-6	-03A9-6	-06A1-6	-09A0-6	-011A-6	-017A-6	-022A-6	-027A-6
Motor Horsepower	2	3	5	7.5	10	15	20	25
Motor KW	1.5	2.2	3.7	5.6	7.5	11.2	14.9	18.7
Frame Size	R2	R2	R2	R2	R2	R2	R3	R3
Output Current Amps @ 40°C	2.7	3.9	6.1	9	11	17	22	27
Overload Current Rating	110% for 1 minute every 10 minutes							
Max Output Voltage	3 Phase 0 volts up to input voltage max.							
Rated Input Voltage	500/525/575/600 +10% -15% VAC 3 phase 48/63Hz +/- 3%							
Rated Input Current Amps @ 40°C (Use on Unit ID Nameplate)	2.7	3.9	6.1	9	11	17	22	27
Recommended Class T Fuse Size (Amps)	15	15	15	15	15	30	40	40
Maximum Power Cable Size AWG	6	6	6	6	6	6	2	2
Heat Loss in watts 100 % load	66	84	133	174	228	322	430	525
Efficiency (%) min.	Approximately 98% at nominal load							
Environment								
Ambient Temperature	-15 to +50 °C (5 to 122 °F): No frost allowed / Output derated above +40 °C (104 °F)							
Storage Temperature	-40°C to 70°C -40 - 158' F							
Humidity	5 to 95% No condensation allowed Maximum relative humidity is 60% in the presence of corrosive gasses							
Altitude	MAX 3,300 feet without de-rate. 1% derate for each 330 feet above 3,300 up to 6,600' / Above 6,600' Contact Tech Support for additional derating (Max Altitude to 13,123' with Derate)							
Enclosure	Nema 1 Fan Cooled / with Conduit Box Included as Standard							
Weight kg approximate	6.60	6.60	6.60	6.60	6.60	6.60	11.80	11.80
Weight Lbs approximate	14.60	14.60	14.60	14.60	14.60	14.60	26.00	26.00
Input Frequency	48-63 Hz							
Imbalance	maximum +/- 3% of nominal phase to phase input voltage							
Fundamental Power Factor (cos phi)	0.98 at nominal load							
Frequency Resolution	0.01Hz							
Maximum motor cable length	100 M (R1); 200 M (R2); 300 M (R3-R9) max without output filterers							
Heat Loss in BTU/Hr 100 % load	224	288	454	593	777	1100	1469	1791
Air Flow m3/h	101	101	101	101	101	101	179	179
Air Flow ft3/min	59	59	59	59	59	59	105	105
Sinusoidal Vibration (IEC 60068-2-6)	Mechanical conditions: IEC 60068-2 , 2....13.2Hz 1mm (0.04in) , 13.2...100Hz 7m/s2 (23 ft/s2)							
Output Current Derating								
Temperature 1% per degree C above 40°C IE: 50°C=output* 0.90	-15 to +50 °C (5 to 122 °F): No frost allowed / Output derated above +40 °C (104 °F)							
Altitude: 1% of output for every 330 feet above 3,300 feet	MAX 3,300 feet without de-rate. 1% derate for each 330 feet above 3,300 up to 6,600' / Above 6,600' Contact Tech Support for additional derating (Max Altitude to 13,123' with Derate)							
Switching Frequency: 2, 4, 8 or 12 kHz. See User Manual for Derate	Switching Frequency: 2, 4, 8 or 12 kHz Please see User Manual for Proper Derates at Carrier Frequencies above 4KHz. / Automatic fold back in case of overload							

1% derate for each 330 feet above 3,300

Performance Data (continued)

TABLE 9 - PERFORMANCE DATA 50-600 VAC (CONT'D)

AYK JCI Drive	Special Note: Plus Code +P940 = Base Drive Less Cover and Less Conduit Box / IP20							
ABB Model	AYK 580-01	AYK 580-01	AYK 580-01	AYK 580-01	AYK 580-01	AYK 580-01	AYK 580-01	AYK 580-01
Series	-032A-6	-041A-6	-052A-6	-062A-6	-077A-6	-099A-6	-125A-6	-144A-6
Motor Horsepower	30	40	50	60	75	100	125	150
Motor KW	22.4	29.8	37.3	44.8	56.0	74.6	93.3	111.9
Frame Size	R3	R5	R5	R5	R5	R7	R7	R8
Output Current Amps @ 40°C	32	41	52	62	77	99	125	144
Overload Current Rating	110% for 1 minute every 10 minutes							
Max Output Voltage	3 Phase 0 volts up to input voltage max.							
Rated Input Voltage	500/525/575/600 +10% -15% VAC 3 phase 48/63Hz +/- 3%							
Rated Input Current Amps @ 40°C (Use on Unit ID Nameplate)	32	41	52	62	77	99	125	144
Recommended Class T Fuse Size (Amps)	40	100	100	100	100	150	200	250
Maximum Power Cable Size AWG	2	2/0	2/0	2/0	2/0	500MCM	500MCM	(2) 300MCM
Heat Loss in watts 100 % load	619	835	1024	1240	1510	2061	2466	3006
Efficiency (%) min.	Approximately 98% at nominal load							
Environment								
Ambient Temperature	-15 to +50 °C (5 to 122 °F): No frost allowed / Output derated above +40 °C (104 °F)							
Storage Temperature	-40°C to 70°C -40 - 158° F							
Humidity	5 to 95% No condensation allowed Maximum relative humidity is 60% in the presence of corrosive gasses							
Altitude	MAX 3,300 feet without de-rate. 1% derate for each 330 feet above 3,300 up to 6,600' / Above 6,600' Contact Tech Support for additional derating (Max Altitude to 13,123' with Derate)							
Enclosure	Nema 1 Fan Cooled / with Conduit Box Included as Standard							
Weight kg approximate	11.80	28.30	28.30	28.30	28.30	54.00	54.00	69.00
Weight Lbs approximate	26.00	62.40	62.40	62.40	62.40	119.10	119.10	152.00
Input Frequency	48-63 Hz							
Imbalance	maximum +/- 3% of nominal phase to phase input voltage							
Fundamental Power Factor (cos phi)	0.98 at nominal load							
Frequency Resolution	0.01Hz							
Maximum motor cable length	100 M (R1); 200 M (R2); 300 M (R3-R9) max without output filters							
Heat Loss in BTU/Hr 100 % load	2114	2852	3497	4235	5157	7039	8422	10266
Air Flow m3/h	139	139	139	139	139	450	450	550
Air Flow ft3/min	82	82	82	82	82	265	265	265
Sinusoidal Vibration (IEC 60068-2-6)	Mechanical conditions: IEC 60068-2, 2....13.2Hz 1mm (0.04in) , 13.2...100Hz 7m/s2 (23 ft/s2)							
Output Current Derating								
Temperature 1% per degree C above 40°C IE: 50°C=output* 0.90	-15 to +50 °C (5 to 122 °F): No frost allowed / Output derated above +40 °C (104 °F)							
Altitude: 1% of output for every 330 feet above 3,300 feet	MAX 3,300 feet without de-rate. 1% derate for each 330 feet above 3,300 up to 6,600' / Above 6,600' Contact Tech Support for additional derating (Max Altitude to 13,123' with Derate)							
Switching Frequency: 2, 4, 8 or 12 kHz. See User Manual for Derate	Switching Frequency: 2, 4, 8 or 12 kHz Please see User Manual for Proper Derates at Carrier Frequencies above 4KHz. / Automatic fold back in case of overload							

1% derate for each 330 feet above 3,300

Performance Data (continued)

TABLE 9 - PERFORMANCE DATA 50-600 VAC (CONT'D)

AYK JCI Drive	Special Note: Plus Code +P940 = Base Drive Less Cover and Less Conduit Box / IP20		
ABB Model	AYK 580-01	AYK 580-01	AYK 580-01
Series	192A-6	242A-6	271A-6
Motor Horsepower	200	250	250
Motor KW	149.2	186.5	186.5
Frame Size	R9	R9	R9
Output Current Amps @ 40°C	192	242	271
Overload Current Rating	110% for 1 minute every 10 minutes		
Max Output Voltage	3 Phase 0 volts up to input voltage max.		
Rated Input Voltage	500/525/575/600 +10% -15% VAC 3 phase 48/63Hz +/- 3%		
Rated Input Current Amps @ 40°C (Use on Unit ID Nameplate)	192	242	271
Recommended Class T Fuse Size (Amps)	300	400	400
Maximum Power Cable Size AWG	(2) 500MCM	(2) 500MCM	(2) 500MCM
Heat Loss in watts 100 % load	4086	4896	4896
Efficiency (%) min.	Approximately 98% at nominal load		
Environment			
Ambient Temperature	-15 to +50 °C (5 to 122 °F): No frost allowed / Output derated above +40 °C (104 °F)		
Storage Temperature	-40°C to 70°C -40 - 158° F		
Humidity	5 to 95% No condensation allowed Maximum relative humidity is 60% in the presence of corrosive gasses		
Altitude	MAX 3,300 feet without de-rate. 1% derate for each 330 feet above 3,300 up to 6,600' / Above 6,600' Contact Tech Support for additional derating (Max Altitude to 13,123' with Derate)		
Enclosure	Nema 1 Fan Cooled / with Conduit Box Included as Standard		
Weight kg approximate	97.00	97.00	97.00
Weight Lbs approximate	213.90	213.90	213.90
Input Frequency	48-63 Hz		
Imbalance	maximum +/- 3% of nominal phase to phase input voltage		
Fundamental Power Factor (cos phi)	0.98 at nominal load		
Frequency Resolution	0.01Hz		
Maximum motor cable length	100 M (R1); 200 M (R2); 300 M (R3-R9) max without output fitters		
Heat Loss in BTU/Hr 100 % load	13954	16721	16721
Air Flow m3/h	1150	1150	1150
Air Flow ft3/min	677	677	677
Sinusoidal Vibration (IEC 60068-2-6)	Mechanical conditions: IEC 60068-2 , 2....13.2Hz 1mm (0.04in) , 13.2...100Hz 7m/s2 (23 ft/s2)		
Output Current Derating			
Temperature 1% per degree C above 40°C IE: 50°C=output* 0.90	-15 to +50 °C (5 to 122 °F): No frost allowed / Output derated above +40 °C (104 °F)		
Altitude: 1% of output for every 330 feet above 3,300 feet	MAX 3,300 feet without de-rate. 1% derate for each 330 feet above 3,300 up to 6,600' / Above 6,600' Contact Tech Support for additional derating (Max Altitude to 13,123' with Derate)		
Switching Frequency: 2, 4, 8 or 12 kHz. See User Manual for Derate	Switching Frequency: 2, 4, 8 or 12 kHz Please see User Manual for Proper Derates at Carrier Frequencies above 4KHz. / Automatic fold back in case of overload		

1% derate for each 330 feet above 3,300

Performance Data (continued)

TABLE 10 - TEMPERATURE DERATING CHART

AMBIENT TEMP.		PERCENT DERATING
°F	°C	
104	40	0%
113	45	5%
122	50	10%

Temperature Derate example:

A 5HP, 460V at 122°F (50°C)
 Drive FLA=8.8 x 0.90=7.92 amps

Note: Max Ambient Temperature
 122°F (50°C) with a derate of 10%

TABLE 11 - ALTITUDE DERATING CHART

ALTITUDE		PERCENT DERATING Of Drive Output Amps
FEET	METERS	
3280	1000	0%
4920	1500	5%
6560	2000	10%

Altitude Derate Calculation Example:

A 5HP, 460V rated at 7.6 installed at
 6560 ft. (2000m) altitude.
 .6 x 0.90 = .84 Amps

Derate 1% for each additional 330 feet (100m) above
 3280 ft (1000m)

Carrier Frequency De-Rate:

1-150HP

Default Setting: 4kHz

Low Noise 8kHz w/ 20% De-Rate

Example: VFD Output Current * .80

10HP, 460V, 14 amps x .80=11.2 A

When Carrier Frequency Set for 8kHz.

Product Overview



FIGURE 43 - AYK580 WALL MOUNT DRIVE

Product Overview - AYK580-01

The AYK580 drive sets new standards in both simplicity and reliability, and ensures smooth, energy-efficient operation of your HVAC systems in normal and mission-critical situations.

AYK580-01, wall-mounted base drives

The AYK580-01 wall-mounted drives are available from 1 to 100 HP at 208/240 V, 1 to 350 HP at

480 V, and 2 to 250 HP at 575 V. The AYK580-01 drives are available in UL (NEMA) Type 1 and 12 configurations. In standard installations, the drive is mounted directly onto a wall and uses the provided conduit box. Conduit openings are provided for bottom conduit entry & exit. For mounting in a customer-supplied cabinet, the conduit box may be removed. The drive has a 100 kA SCCR rating when paired with appropriately sized upstream fuses.

Features for HVAC

The AYK580 comes standard with an intuitive control panel used to configure, control, and monitor the drive. An optional Bluetooth control panel allows the drive to be configured via the control panel or the DriveTune app.

A robust HVAC firmware package provides drive, motor, and application protection features. Examples of drive protection features include undervoltage, overvoltage, overcurrent, and ground fault protection. The AYK580 also has a variety of motor protection features including overload and stall protections.

Application specific features, such as accepting four separate start interlocks (safeties), along with broken belt detection, are also included. The drive includes BACnet MS/TP, Modbus RTU, and Johnson N2 as standard. Additional protocols, such as BACnet/IP and LonWorks (coming 2019), are available with optional fieldbus adapters.

Specifications

TABLE 12 - TECHNICAL SPECIFICATIONS

PRODUCT COMPLIANCE (COMPLETE LIST ON FOLLOWING PAGE)	
AYK580-01	CE, UL, cUL
SUPPLY CONNECTION	
Input voltage (U1)	
AYK580-xx-xxxA-2	208...240V
AYK580-xx-xxxA-4	380...480V
AYK580-xx-xxxA-6	515...600V
Input voltage tolerance	+10% / -15%
Phase	3-phase (1-phase, 240 V)
Frequency	48 to 63 Hz
Line Limitations	Max $\pm 3\%$ of nominal phase to phase input voltage
Power Factor (cos ϕ) at nominal load AYK580-01	0.98
Efficiency at rated power AYK580-01	98.0%
Power Loss	Approximately 2% of rated power
MOTOR CONNECTION	
Supported motor control	Scalar and vector
Supported motor types	Asynchronous motor, permanent magnet motor (vector), SynRM (vector)
Voltage	3-phase, from 0 to supply voltage
Frequency	0 to 500 Hz
Short Term Overload Capacity Variable Torque	110% for 1 min/10min
Peak Overload Capacity	1.35 for 2 second
Variable Torque	(2 sec / 10 min)
Switching Frequency	2, 4, 8 or 12 kHz Automatic fold back in case of overload
Acceleration/Deceleration Time	0 to 1800 s
Short Circuit Current Rating (SCCR)	100 ka with fusing
INPUTS AND OUTPUTS (DRIVE)	
2 analog inputs	Selection of Current/Voltage input mode is user programmable.
Voltage reference	0 (2) to 10 V, $R_{in} > 200 \text{ k}\Omega$
Current reference	0 (4) to 20 mA, $R_{in} = 100 \Omega$
Potentiometer reference value	10 V $\pm 1\%$ max. 20 mA
2 analog outputs	AO1 is user programmable for current or voltage. AO2 current
Voltage reference	0 to 10 V, $R_{load} > 100 \text{ k}\Omega$
Current reference	0 to 20 mA, $R_{load} < 500 \Omega$
Applicable potentiometer	1 k Ω to 10 k Ω
Internal auxiliary voltage	24 V DC $\pm 10\%$, max. 250 mA
Accuracy	+/- 1% full scale range at 25°C (77°F)
Output updating time	2 ms
6 digital inputs	12 to 24 V DC, 10 to 24 V AC, Connectivity of PTC sensors supported by a single digital input. PNP or NPN connection (5 DIs with NPN connection). Programmable

TABLE 12 - TECHNICAL SPECIFICATIONS (CONT'D)

Input Updating Time	2 ms
3 relay outputs	Maximum switching voltage 250 V AC/30 V DC. Maximum continuous current 2 A rms. Programmable, Form C
Adjustable filters on analog inputs and outputs	
All control inputs isolated from ground and power	
OPERATION	
Air temperature	0 to -15 °C (32 to 5 °F). -15 to +50 °C (5 to 122 °F): No frost allowed. Output derated above +40 °C (104 °F)
Installation site altitude	0 to 4000 m (13123 ft) above sea level Output derated above 1000 m (3281 ft)
Relative humidity	5 to 95% No condensation allowed Maximum relative humidity is 60% in the presence of corrosive gasses
Atmospheric pressure	70 to 106 kPa (10.2 to 15.4 PSI) 0.7 to 1.05 atmospheres
Vibration	Risk category IV Certified (IBC 2018)
ENVIRONMENTAL PROTECTIONS	
Chemical Gasses	Class 3C2
Solid Particles	Class 3S2 No conductive dust allowed
Pollution degree (IEC/EN 61800-5-1)	Pollution degree 2
PRODUCT COMPLIANCE	
Standards and directives	Low Voltage Directive 2006/95/EC EMC Directive 2004/108/EC 60721-3-3: 2002 60721-3-1:1997 Quality assurance system ISO 9001 and Environmental system ISO 14001 CE, UL, cUL, and EAC approvals Galvanic isolation according to PELV RoHS2 (Restriction of Hazardous Substances) EN 61800-5-1: 2007; IEC/EN 61000-3-12; EN61800-3: 2017 + A1: 2012 Category C2 (1st environment restricted distribution); Safe torque off (EN 61800-5-2) BACnet Testing Laboratory (BTL) Seismic (IBC, OSHPD) Plenum (AYK580-01 only)
EMC (according to EN61800-3)	AYK580-01 class C2 (1st environment restricted distribution)

Specifications (continued)

TABLE 12 - TECHNICAL SPECIFICATIONS (CONT'D)

STORAGE (IN PROTECTIVE SHIPPING PACKAGE)	
Air Temperature	-40 to +70 °C (-40 to +158 °F)
Relative Humidity	Less than 95% No condensation allowed Maximum relative humidity is 60% in the presence of corrosive gasses
Chemical Gasses	Class 1C2
Solid Particles	Class 1S2 Contact ABB regarding Class 1S3
Atmospheric pressure	70 to 106 kPa 0.7 to 1.05 atmospheres
Vibration (ISTA)	
R1...R4	In accordance with ISTA 1A
R5...R9	In accordance with ISTA 3E
TRANSPORTATION (IN PROTECTIVE SHIPPING PACKAGE)	
Air Temperature	-40° to 70°C (-40° to 158°F)
Relative Humidity	Less than 95% No condensation allowed Maximum relative humidity is 60% in the presence of corrosive gasses
Atmospheric Pressure	60 to 106 kPa (8.7 to 15.4 PSI) 0.6 to 1.05 atmospheres
Free Fall	R1: 76 cm (30 in) R2: 61 cm (24 in) R3: 46 cm (18 in) R4: 31 cm (12 in) R5: 25 cm (10 in)
Chemical Gasses	Class 2C2
Solid Particles	Class 2S2
Shock/ Drop (ISTA)	
R1...R4	In accordance with ISTA 1A
R5...R9	In accordance with ISTA 3E
Vibration (ISTA)	
R1...R4	In accordance with ISTA 1A
R5...R9	In accordance with ISTA 3E

Feature Overview

Communication

Protocols as standard (EIA-485): BACnet MS/TP, Modbus RTU, Johnson Controls N2

Available as plug-in options: BACnet/IP, Modbus TCP, PROFIBUS-DP, DeviceNet, EtherNet/IP, LonWorks (coming 2019)

Application functions

- Start interlock
- Delayed start
- Run permissive (damper monitoring)
- Override operation mode
- Real-time clock (scheduling)
- PID controllers for motor and process
- Motor flying start
- Motor preheating
- Energy optimizer and calculators
- Timer
- 2 or 3 wire start/stop
- Ramp to stop
- 2 independent adjustable accel/decel ramp

Protection functions

- Overvoltage controller
- Undervoltage controller
- Motor earth-leakage monitoring
- Motor short-circuit protection
- Motor overtemperature protection
- Output and input switch supervision
- Motor overload protection (UL508C)
- Phase-loss detection (both motor and supply)
- Under load supervision (belt loss detection)
- Overload supervision
- Stall protection
- Loss of reference
- Panel loss
- Ground fault
- External events
- Overcurrent
- Current limit regulator
- Transient/Surge protection (MOV and choke)

Panel functions

- First start assistant
- Primary settings for HVAC applications
- Hand-Off-Auto operation mode
- HVAC quick set-up

- Includes Day, Date and Time
- Operator Panel Parameter Backup (read/write)
- Full Graphic and Multilingual Display for Operator Control, Parameter Set-Up and Operating Data Display:
 - Output Frequency (Hz)
 - Speed (RPM)
 - Motor Current
 - Calculated % Motor Torque
 - Calculated Motor Power (kW)
 - DC Bus Voltage
 - Output Voltage
 - Heatsink Temperature
 - Elapsed Time Meter (resettable)
 - kWh (resettable)
 - Input / Output Terminal Monitor
 - PID Actual Value (Feedback) & Error Fault Text
 - Warning Text
 - Three (3) Scalable Process Variable Displays
 - User-Definable Engineering Units

Motor control features

- Scalar (V/Hz) and vector modes of motor control
- Supported motor types
 - Asynchronous motor,
 - Permanent magnet motor (vector),
 - SynRM (vector)Squared
- V/Hz shapes
 - Linear
 - Squared
- Energy optimization
- IR compensation
- Slip compensation
- Three (3) Critical Frequency Lockout Bands

PID Control

- One (1) Process PID
- Four (4) Integral Independent Programmable PID
- Setpoint Controllers (Process and External)
- External Selection between Two (2) Sets of Process
- PID Controller Parameters
- PID Sleep/Wake-U

Feature Overview (continued)

STANDARD FEATURES (UNIQUE TO AYK580-PF/CF) DRIVE WITH INPUT DISCONNECT OR CLASSIC BYPASS

Standards

- UL, 508

Features Unique to AYK580 Drive with Input Disconnect (AYK580-PF)

- Main Input Fused Disconnect ONLY
- Main Input Fused Disconnect Lockable
- (Open Position)
- Nema 3R units
- (Std. w/CPT, Heater & Thermostat Setting)
- All features as defined in Base Drive Features

Features Unique to AYK580 Drive Pack with Bypass (AYK580-CF)

- Main Input Fused Disconnect ONLY
- Main Input Fused Disconnect Lockable
- (Open Position)
- Control Power Transformer
- Two Contactor Classic Bypass
- (Mechanically interlocked)
- Contactors are ABB (AF) Wide Range
- Electronic Coil Type
- Motor Bypass Electronic Overload selectable
- (Class 10, 20 or 30 / Default Set Class 20)
- Fused Drive Input Service Switch as Standard
- Nema 3R units
- (Std. w/CPT, Heater & Thermostat Setting)
- All features as defined in Base Drive Features

LAYOUT OF THE STANDARD HAND-OFF-AUTO PANEL CONTROL PANEL

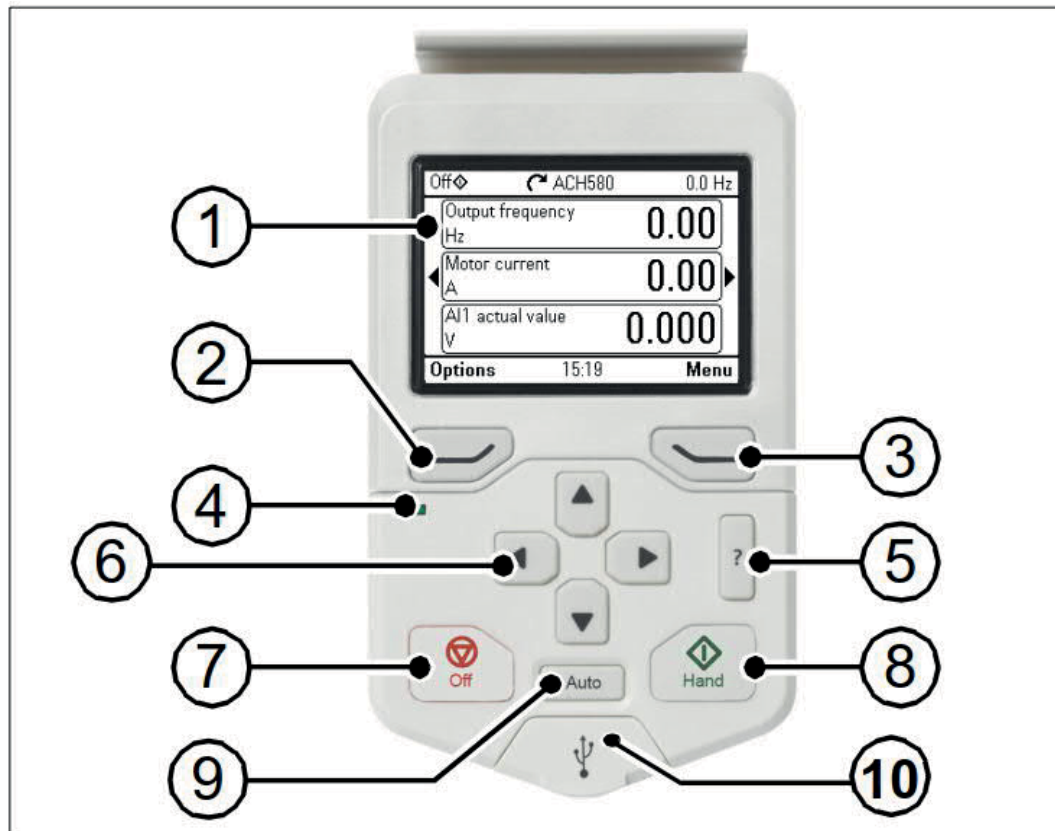





CALLOUT	DESCRIPTION	CALLOUT	DESCRIPTION
1	Layout of the control panel display	6	Arrow keys
2	left softkey	7	Off (see Hand, Off, and Auto)
3	Right softkey	8	Hand (see Hand, Off, and Auto)
4	Status LED, see the <i>LEDs</i> section in <i>Maintenance and Hardware Diagnostics</i> in the <i>Hardware Manual of the Drive</i>	9	Auto (see Hand, Off, and Auto)
5	Help	10	USB connector

FIGURE 44 - STANDARD HAND-OFF-AUTO PANEL CONTROL PANEL LAYOUT

Switches and LEDs

Switches

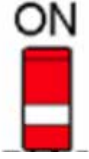
TABLE 13 - SWITCHES

SWITCH	DESCRIPTION	POSITION	
S4 (TERM)	EFB link termination. Must be set to the terminated (ON) position when the drive is the first or last unit on the link.		Bus not terminated
			Bus terminated
S5 (BIAS)	Activated on the biasing voltages to the bus. One (and only one) device, preferably at the end of the bus must have the bias on.		Bias off (default)
			Bias on

LEDS

Drive LEDs

There is a green POWER and a red FAULT LED on the front of the drive. They are visible through the panel cover but invisible if a control panel is attached to the drive. The following table describes the drive LED indications

Drive LEDs POWER and FAULT, on the front of the drive, under the control panel/panel cover

If a control panel is attached to the drive, switch to remote control (otherwise a fault is generated), and then remove the panel to be able to see the LEDs.

TABLE 14 - LEDES

LEDS OFF	LED LIT AND STEADY		LED BLINKING	
No power	Green (POWER)	Power supply on the board OK	Green (POWER)	Blinking: Drive in an alarm state Blinking for one second:
	Red (FAULT)	Active fault in the drive. To reset the fault, press RESET from the control panel or switch off the drive power.	Red (FAULT)	Drive selected on the control panel when multiple drives are connected to the same panel bus Active fault in the drive. To reset the fault, switch off the drive power.

Installation

Study the installation instructions of the AYK580-01 manual carefully before proceeding. Failure to observe the warnings and instructions may cause a malfunction or personal hazard.

WARNING: Before you begin, read the Safety Instructions in AYK580-01-IOM

1. Check the free space requirements

The drive must be installed on the wall. There are two alternative ways to install it.

NOTE: Do not install upside down.

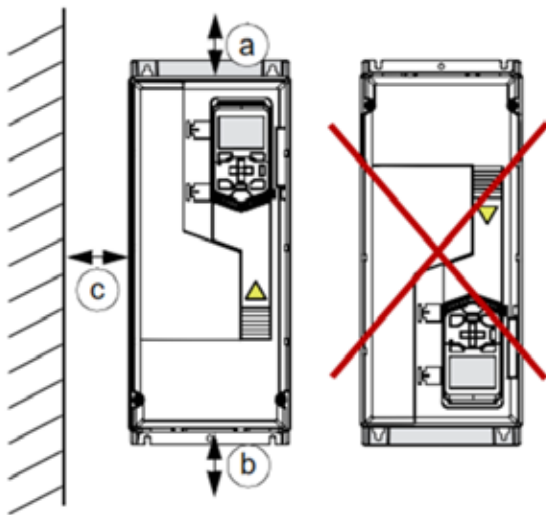

TABLE 15 - VERTICALLY ALONE CLEARANCES

FRAME SIZE	VERTICAL INSTALLATION - FREE SPACE					
	ALOVE (A)		BELOW (B)		BESIDE (C)*	
	MM	IN.	MM	IN.	MM	IN.
R1	200	7.87	150	5.91	150	5.91
R2	200	7.87	150	5.91	150	5.91
R3	200	7.87	200	7.87	150	5.91
R4	53	2.09	200	7.87	150	5.91
R5	100	3.94	200	7.87	150	5.91
R6	155	6.10	300	11.81	150	5.91
R7	155	6.10	300	11.81	150	5.91
R8	155	6.10	300	11.81	150	5.91
R9	200	7.87	300	11.81	150	5.91

3AXD00000586715

*Free space between the drive and other objects, for example, walls

FIGURE 45 - INSTALLING UNIT VERTICALLY ALONE

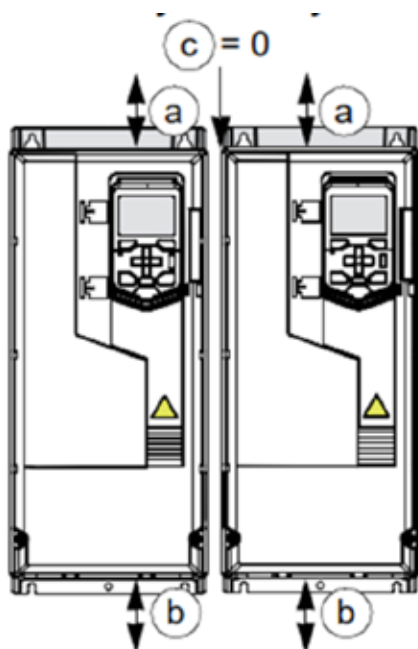

TABLE 16 - VERTICAL SIDE BY SIDE CLEARANCES

FRAME SIZE	VERTICAL INSTALLATION SIDE BY SIDE FREE SPACE					
	ALOVE (A)		BELOW (B)*		BESIDE (C)	
	MM	IN.	MM	IN.	MM	IN.
R1	200	7.87	200	7.87	0	0
R2	200	7.87	200	7.87	0	0
R3	200	7.87	200	7.87	0	0
R4	200	7.87	200	7.87	0	0
R5	200	7.87	200	7.87	0	0
R6	200	7.87	300	11.81	0	0
R7	200	7.87	300	11.81	0	0
R8	200	7.87	300	11.81	0	0
R9	200	7.87	300	11.81	0	0

* Free space below is always measured from the drive frame, not from the cable box.

FIGURE 46 - INSTALLING UNIT VERTICALLY SIDE BY SIDE

Installation (continued)

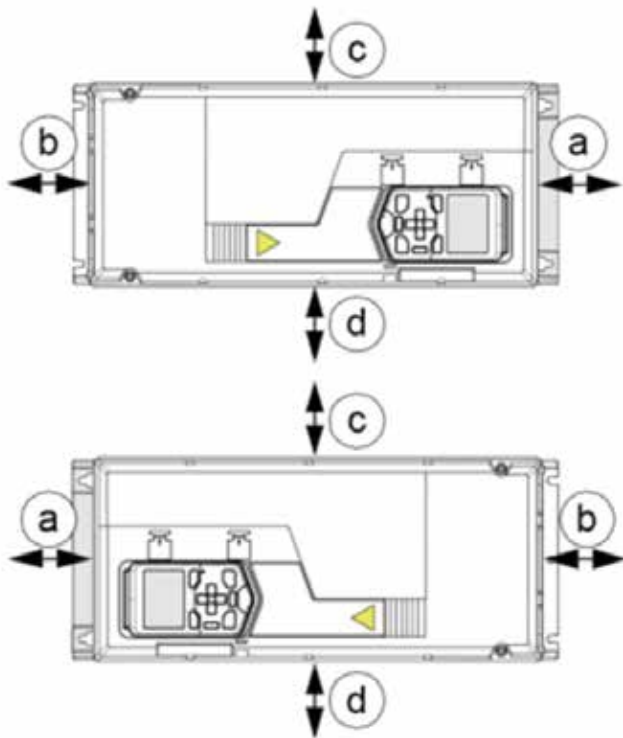

**TABLE 17 - HORIZONTAL SIDE BY SIDE
INSTALLATION CLEARANCES**

FRAME SIZE	IP21 (IP20)			
	ABOVE (A)		BELOW (B)*	
	MM	IN.	MM	IN.
R1	150	5.91	86	3.39
R2	150	5.91	86	3.39
R3	200	7.87	53	2.09
R4	30	1.18	200	7.87
R5	30	1.18	200	7.87
FRAME SIZE	SIDE UP (C)		SIDE DOWN (D)	
	MM	IN.	MM	IN.
R1	30	1.18	200	7.87
R2	30	1.18	200	7.87
R3	30	1.18	200	7.87
R4	30	1.18	200	7.87
R5	30	1.18	200	7.87

*Free space below is always measured from the drive frame, not from the cable box

FIGURE 47 - HORIZONTAL SIDE BY SIDE INSTALLATION

NOTE:

1. You can install IP21 / UL Type 1 drives horizontally but the installation meets IP29 requirements only.
2. In the horizontal mounting, the drive is not protected from dripping water
3. The vibration specification in the Ambient Conditions section may not be fulfilled.

EMC AND VAR SCREWS

WARNING: Do not install the drive with the EMC filters or VAR circuit enabled to an electrical power system that the filter is not rated for or unknown. This can cause danger and damage the drive.

NOTE: When the internal EMC filters are disconnected, the EMC protection of the drive is considerably reduced.

Identifying different types of electrical power systems

The power network can be determined with a RMS multimeter. When identified, the EMC and VAR screws may be correctly configured for that power system.

TABLE 18 - POWER SYSTEM IDENTIFICATION

U_{L-L}	U_{L1-G}	U_{L2-G}	U_{L3-G}	ELECTRICAL POWER SYSTEM TYPE	FIGURE
X	0.58x	0.58x	0.58x	TN System (Symmetrically grounded wye)	A
X	1.0x	1.0x	0	Corner-grounded Delta System (non-symmetrical)	B
X	0.866x	0.5x	0.5x	Midpoint-grounded Delta System (non-symmetrical)	C
X	Varying level versus time	Varying level versus time	Varying level versus time	IT System (ungrounded or high-resistance-grounded [>30 ohms] non-symmetrical)	D
X	Varying level versus time	Varying level versus time	Varying level versus time	TT System (the protective earth connection for the customer is provided by a local earth electrode, and there is another independently installed at the generator)	E

1. Input voltage line to line (U_{L-L})
2. Input voltage line 1 to ground (U_{L1-G})
3. Input voltage line 2 to ground (U_{L2-G})
4. Input voltage line 3 to ground (U_{L3-G})

T - Terra (ground)

N - Neutral

C - Combined

S - Separate

I - Isolated

TN-S = Terra Neutral - Separate

Earth and Neutral have separate conductors (3 wire single phase L, N, E).

IT = Isolated Neutral

Earth is either ungrounded or high-resistive (>30 ohms) non-symmetrical earth path.

TT = Tera Tera

Earth at source and Earth at destination (no earth conductor between source and consumer, the soil is used as the earth return path)

Installation (continued)

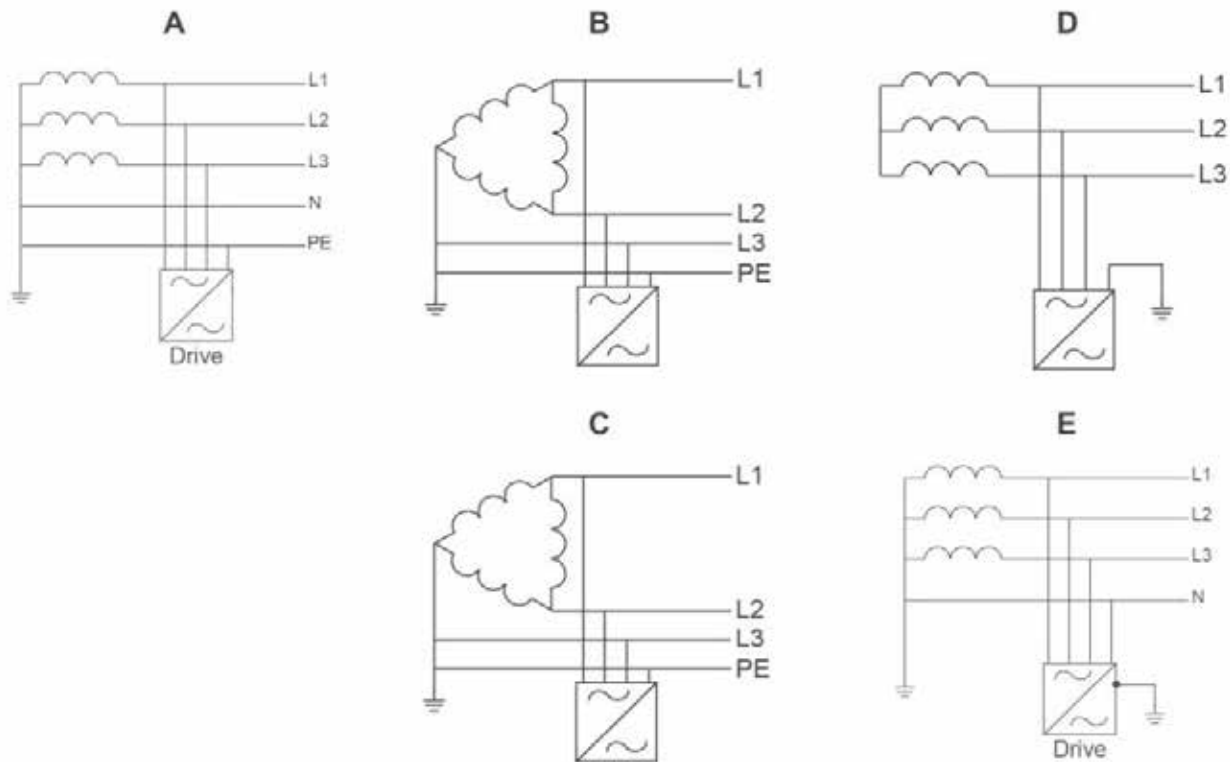
FIGURE 48 - ELECTRICAL POWER SYSTEM TYPES

Default EMC and VAR screws material

The following tables show the default material based on the drive frame and manufactured location (North America or except North America).

TABLE 19 - DEFAULT MATERIAL

FRAME	DEFAULT SCREW MATERIAL (NORTH AMERICA)			FRAME	DEFAULT SCREW MATERIAL (EXCEPT NORTH AMERICA)		
	EMC (DC)	EMC (AC)	VAR		EMC (DC)	EMC (AC)	VAR
R1...R3	Nylon	N/A	Metal	R1...R3	Nylon	N/A	Metal
R4...R5	Nylon	Nylon	Metal	R4...R5	Nylon	Metal	Metal
R6...R9*	Nylon	Nylon	Metal	R6...R9*	Nylon	Metal	Metal

NOTE: *The R7 has no EMC (DC) screw for 600 V.

EMC/VAR screw type selection for various power networks

The following describes the purpose of the EMC filter and the varistor (VAR) and how to configure based on the electrical power systems the drive will be connected.

WARNING: Disconnect EMC filter and VAR circuits when power network is unknown.

EMC filter

The EMC filter in the drive reduces the electromagnetic noise produced by the drive. Electromagnetic noise could interfere with or affect other electrical products. The EMC filter needs to be configured prior to installing the drive on the electrical power system to provide the proper EMC protection.

Varistor

The varistor (VAR) is a metal oxide varistor (MOV), which is used to protect the sensitive electronics in the drive caused by transient overvoltage conditions. The ground-to-phase varistor needs to be configured prior to installing the drive on the electrical power system to provide correct protection.

Replacement parts kits and torque values

TABLE 20 - SCREW KIT, HARDWARE R1-R4, R6-R9 PART NUMBER: 3AXD50000561261

QTY	DESCRIPTION	LOCATION	BIT SIZE	TORQUE
1	Screw, M4x12, COMBI, Torx, T20 Steel	EMC/VAR	T20	1.5 Nm
1	Screw, M4x12, PZ1, Nylon	EMC/VAR	PZ1	Hand tighten

TABLE 21 - SCREW KIT, HARDWARE R5 PART NUMBER: 3AXD50000561278

QTY	DESCRIPTION	LOCATION	BIT SIZE	TORQUE
1	Screw, M5x16, COMBI, Torx, T20 steel	EMC (AC)/VAR	T20	3.0 Nm
1	Screw, M6x16, PZ1, Nylon	EMC (AC)/VAR	PZ1	Hand tighten
1	Screw, M5x35, COMBI, Torx, T20 steel	EMC (DC)	T20	3.0 Nm
1	Screw, M6x35, PZ1, Nylon	EMC (DC)	PZ1	Hand tighten

TABLE 22 - AYK-580-01 NORTH AMERICA

		TN SYSTEM OF CORNER-GROUNDED DELTA SYSTEM	TN SYSTEM	CORNER-GROUNDED DELTA (B) AND MID- POINT-GROUNDED DELTA (C)	IT SYSTEM	TT SYSTEM
FRAME	CONNECTION	DEFAULT FIGURES A AND B	FIGURE A	FIGURES B AND C	FIGURE D	FIGURE E
R1...R3	EMC (DC)	Nylon	Metal ²	Nylon ¹	Nylon ¹	Nylon ¹
	VAR	Metal	Metal	Metal	Nylon ¹	Nylon ¹
R4 ³	EMC (DC)	Nylon	Metal ²	Nylon ¹	Nylon ¹	Nylon ¹
	EMC (AC)	Nylon	Metal ²	Nylon ¹	Nylon ¹	Nylon ¹
	VAR	Metal	Metal	Metal	Nylon ¹	Nylon ¹
R5 ³	EMC (DC)	Nylon	Metal ²	Nylon ¹	Nylon ¹	Nylon ¹
	EMC (AC)	Nylon	Metal ²	Metal ²	Nylon ¹	Nylon ¹
	VAR	Metal	Metal	Metal	Nylon ¹	Nylon ¹
R6...R9	EMC (DC)	Nylon	Metal ²	Nylon ¹	Nylon ¹	Nylon ¹
	EMC (AC)	Nylon	Metal ²	Metal ²	Nylon ¹	Nylon ¹
	VAR	Metal	Metal	Metal	Nylon ¹	Nylon ¹

NOTE: Bold text represents a change from the default material

¹ Metal screw must not be used

² Optional, for greater noise filtering

³ Frames R4 and R5 are evaluated for use on corner-grounded delta networks by UL standards. R4 and R5 frames may not be used on IEC installations with corner grounded networks.

Installation (continued)

TABLE 23 - AYK580-O1 EXCEPT NORTH AMERICA

FRAME	CONNECTION	TN SYSTEM	IT SYSTEM	TT SYSTEM
		DEFAULT FIGURES A	FIGURE D	FIGURE E
R1...R3	EMC (DC)	Metal	Nylon ¹	Nylon
	VAR	Metal	Metal	Nylon
R4 ³	EMC (DC)	Metal	Nylon ¹	Nylon
	EMC (AC)	Metal	Nylon	Nylon
	VAR	Metal	Metal	Nylon
R5 ³	EMC (DC)	Metal	Nylon ¹	Nylon
	EMC (AC)	Metal	Nylon	Nylon
	VAR	Metal	Nylon	Nylon
R6...R9	EMC (DC)	Metal	Nylon ¹	Nylon
	EMC (AC)	Metal	Nylon	Nylon
	VAR	Metal	Nylon	Nylon

NOTE: Bold text represents a change from the default material

¹ Optional, for greater noise filtering

² Frames R4 and R5 are evaluated for use on corner-grounded delta networks by UL standards. R4 and R5 frames may not be used on IEC installations with corner grounded networks.

Complete Parameters List

GROUP 1	GROUP 5		
Actual values	Diagnostics		
01.01 Motor speed used	05.01 On-time counter	12.27 AI2 min	21.04 Emergency stop mode
01.02 Motor speed estimated	05.02 Run-time counter	12.28 AI2 max	21.05 Emergency stop source
01.03 Motor speed %	05.03 Hours run	12.29 AI2 scaled at AI2 min	21.06 Zero speed limit
01.06 Output frequency	05.04 Fan on-time counter	12.30 AI2 scaled at AI2 max	21.07 Zero speed delay
01.07 Motor current	05.10 Control board temperature	12.101 AI1 percent value	21.08 DC current control
01.08 Motor current % of motor nom	05.11 Inverter temperature	12.102 AI2 percent value	21.09 DC hold speed
01.09 Motor current % of drive nom	05.22 Diagnostic word 3	GROUP 13	21.10 DC current reference
01.10 Motor torque	GROUP 6	Standard AO	21.11 Post magnetization time
01.11 DC voltage	Control and status words	13.02 AO force selection	21.14 Pre-heating input source
01.13 Output voltage	06.01 Main control word	13.11 AO1 actual value	21.16 Pre-heating current
01.14 Output power	06.11 Main status word	13.12 AO1 source	21.18 Auto restart time
01.15 Output power % of motor nom	06.16 Drive status word 1	13.13 AO1 forced value	21.19 Scalar start mode
01.16 Output power % of drive nom	06.17 Drive status word 2	13.15 AO1 unit selection	21.21 DC hold frequency
01.17 Motor shaft power	06.18 Start inhibit status word	13.16 AO1 filter time	21.22 Start delay
01.18 Inverter GWh counter	06.19 Speed control status word	13.17 AO1 source min	21.23 Smooth start
01.19 Inverter MWh counter	06.20 Constant speed status word	13.18 AO1 source max	21.24 Smooth start current
01.20 Inverter kWh counter	06.21 Drive status word 3	13.19 AO1 out at AO1 src min	21.25 Smooth start speed
01.24 Flux actual %	06.22 HVAC status word	13.20 AO1 out at AO1 src max	21.26 Torque boost current
01.30 Nominal torque scale	06.30 MSW bit 11 selection	13.21 AO2 actual value	21.30 Speed compensated stop mode
01.50 Current hour kWh	06.31 MSW bit 12 selection	13.22 AO2 source	21.31 Speed comp stop delay
01.51 Previous hour kWh	06.32 MSW bit 13 selection	13.23 AO2 forced value	21.32 Speed comp stop threshold
01.52 Current day kWh	06.33 MSW bit 14 selection	13.26 AO2 filter time	21.34 Force auto restart
01.53 Previous day kWh	GROUP 7	13.27 AO2 source min	GROUP 22
01.54 Cumulative inverter energy	System info	13.28 AO2 source max	Speed reference selection
01.55 Inverter GWh counter (resettable)	07.03 Drive rating id	13.29 AO2 out at AO2 src min	22.01 Speed ref unlimited
01.56 Inverter MWh counter (resettable)	07.04 Firmware name	13.30 AO2 out at AO2 src max	22.11 Ext1 speed ref1
01.57 Inverter kWh counter (resettable)	07.05 Firmware version	13.91 AO1 data storage	22.12 Ext1 speed ref2
01.58 Cumulative inverter energy (resettable)	07.06 Loading package name	13.92 AO2 data storage	22.13 Ext1 speed function
01.61 Abs motor speed used	07.07 Loading package version	GROUP 15	22.18 Ext2 speed ref1
01.62 Abs motor speed %	07.11 Cpu usage	I/O extension module	22.19 Ext2 speed ref2
01.63 Abs output frequency	07.25 Customization package name	15.01 Extension module type	22.20 Ext2 speed function
01.64 Abs motor torque	07.26 Customization package version	15.02 Detected extension module	22.21 Constant speed function
01.65 Abs output power	07.30 Adaptive program status	15.03 DI status	22.22 Constant speed sel1
01.66 Abs output power % motor nom	07.31 AP sequence state	15.04 RO/DO status	22.23 Constant speed sel2
01.67 Abs output power % drive nom	GROUP 10	15.05 RO/DO force selection	22.24 Constant speed sel3
01.68 Abs motor shaft power	Standard DI, RO	15.06 RO/DO forced data	22.26 Constant speed 1
GROUP 3	10.02 DI delayed status	15.07 RO4 source	22.27 Constant speed 2
Input references	10.03 DI force selection	15.08 RO4 ON delay	22.28 Constant speed 3
03.01 Panel reference	10.04 DI forced data	15.09 RO4 OFF delay	22.29 Constant speed 4
03.02 Panel reference remote	10.21 RO status	15.10 RO5 source	22.30 Constant speed 5
03.05 FB A reference 1	10.22 RO force selection	15.11 RO5 ON delay	22.31 Constant speed 6
03.06 FB A reference 2	10.23 RO forced data	15.12 RO5 OFF delay	22.32 Constant speed 7
03.09 EFB reference 1	10.24 RO1 source	15.22 DO1 configuration	22.41 Speed ref safe
03.10 EFB reference 2	10.25 RO1 ON delay	15.23 DO1 source	22.51 Critical speed function
GROUP 4	10.26 RO1 OFF delay	15.24 DO1 ON delay	22.52 Critical speed 1 low
Warnings and faults	10.27 RO2 source	15.25 DO1 OFF delay	22.53 Critical speed 1 high
04.01 Tripping fault	10.28 RO2 ON delay	15.33 Freq out 1 actual value	22.54 Critical speed 2 low
04.02 Active fault 2	10.29 RO2 OFF delay	15.34 Freq out 1 src min	22.55 Critical speed 2 high
04.03 Active fault 3	10.30 RO3 source	15.35 Freq out 1 src max	22.56 Critical speed 3 low
04.06 Active warning 1	10.31 RO3 ON delay	15.36 Freq out 1 at src min	22.57 Critical speed 3 high
04.07 Active warning 2	10.32 RO3 OFF delay	15.37 Freq out 1 at src max	22.71 Motor potentiometer function
04.08 Active warning 3	10.99 RO/DIO control word	GROUP 19	22.72 Motor potentiometer initial value
04.11 Latest fault	10.101 RO1 toggle counter	Operation mode	22.73 Motor potentiometer up source
04.12 2nd latest fault	10.102 RO2 toggle counter	19.01 Actual operation mode	22.74 Motor potentiometer down source
04.13 3rd latest fault	10.103 RO3 toggle counter	19.11 Ext1/Ext2 selection	22.75 Motor potentiometer ramp time
04.16 Latest warning	GROUP 11	19.18 HAND/OFF disable source	22.76 Motor potentiometer min value
04.17 2nd latest warning	Standard DIO, FI, FO	19.19 HAND/OFF disable action	22.77 Motor potentiometer max value
04.18 3rd latest warning	11.21 DI5 configuration	GROUP 20	22.80 Motor potentiometer ref act
04.40 Event word 1	11.38 Freq in 1 actual value	Start/stop/direction	22.86 Speed reference act 6
04.41 Event word 1 bit 0 code	11.39 Freq in 1 scaled value	20.01 Ext1 commands	22.87 Speed reference act 7
04.43 Event word 1 bit 1 code	11.42 Freq in 1 min	20.02 Ext1 start trigger type	GROUP 23
04.45 Event word 1 bit 2 code	11.43 Freq in 1 max	20.03 Ext1 in1 source	Speed reference ramp
04.47 Event word 1 bit 3 code	11.44 Freq in 1 at scaled min	20.04 Ext1 in2 source	23.01 Speed ref ramp input
04.49 Event word 1 bit 4 code	11.45 Freq in 1 at scaled max	20.05 Ext1 in3 source	23.02 Speed ref ramp output
04.51 Event word 1 bit 5 code	GROUP 12	20.06 Ext2 commands	23.11 Ramp set selection
04.53 Event word 1 bit 6 code	Standard AI	20.07 Ext2 start trigger type	23.12 Acceleration time 1
04.55 Event word 1 bit 7 code	12.02 AI force selection	20.08 Ext2 in1 source	23.13 Deceleration time 1
04.57 Event word 1 bit 8 code	12.03 AI supervision function	20.09 Ext2 in2 source	23.14 Acceleration time 2
04.59 Event word 1 bit 9 code	12.04 AI supervision selection	20.10 Ext2 in3 source	23.15 Deceleration time 2
04.61 Event word 1 bit 10 code	12.11 AI1 actual value	20.21 Direction	23.23 Emergency stop time
04.63 Event word 1 bit 11 code	12.12 AI1 scaled value	20.40 Run permissive	23.28 Variable slope enable
04.65 Event word 1 bit 12 code	12.13 AI1 forced value	20.41 Start interlock 1	23.29 Variable slope rate
04.67 Event word 1 bit 13 code	12.15 AI1 unit selection	20.42 Start interlock 2	GROUP 24
04.69 Event word 1 bit 14 code	12.16 AI1 filter time	20.43 Start interlock 3	Speed reference conditioning
04.71 Event word 1 bit 15 code	12.17 AI1 min	20.44 Start interlock 4	24.01 Used speed reference
	12.18 AI1 max	20.45 Start interlock stop mode	24.02 Used speed feedback
	12.19 AI1 scaled at AI1 min	20.46 Run permissive text	24.03 Speed error filtered
	12.20 AI1 scaled at AI1 max	20.47 Start interlock 1 text	24.04 Speed error inverted
	12.21 AI2 actual value	20.48 Start interlock 2 text	24.11 Speed correction
	12.22 AI2 scaled value	20.49 Start interlock 3 text	24.12 Speed error filter time
	12.23 AI2 forced value	20.50 Start interlock 4 text	
	12.25 AI2 unit selection	20.51 Start interlock condition	
	12.26 AI2 filter time	GROUP 21	
		Start/stop mode	
		21.01 Start mode	
		21.02 Magnetization time	
		21.03 Stop mode	

Complete Parameters List (continued)

40.73	Set 1 compensated output 1
40.74	Set 1 compensation input 2
40.75	Set 1 compensated output 2
40.76	Set 1 compensation non-linearity
40.80	Set 1 PID output min source
40.81	Set 1 PID output max source
40.89	Set 1 setpoint multiplier
40.90	Set 1 feedback multiplier
40.91	Feedback data storage
40.92	Setpoint data storage
40.96	Process PID output %
40.97	Process PID feedback %
40.98	Process PID setpoint %
40.99	Process PID deviation %
GROUP 41	
Process PID set 2	
41.08	Set 2 feedback 1 source
41.09	Set 2 feedback 2 source
41.10	Set 2 feedback function
41.11	Set 2 feedback filter time
41.14	Set 2 setpoint scaling
41.15	Set 2 output scaling
41.16	Set 2 setpoint 1 source
41.17	Set 2 setpoint 2 source
41.18	Set 2 setpoint function
41.19	Set 2 internal setpoint sel1
41.20	Set 2 internal setpoint sel2
41.21	Set 2 internal setpoint 1
41.22	Set 2 internal setpoint 2
41.23	Set 2 internal setpoint 3
41.24	Set 2 internal setpoint 0
41.26	Set 2 setpoint min
41.27	Set 2 setpoint max
41.28	Set 2 setpoint increase time
41.29	Set 2 setpoint decrease time
41.30	Set 2 setpoint freeze enable
41.31	Set 2 deviation inversion
41.32	Set 2 gain
41.33	Set 2 integration time
41.34	Set 2 derivation time
41.35	Set 2 derivation filter time
41.36	Set 2 output min
41.37	Set 2 output max
41.38	Set 2 output freeze enable
41.39	Set 2 deadband range
41.40	Set 2 deadband delay
41.43	Set 2 sleep level
41.44	Set 2 sleep delay
41.45	Set 2 sleep boost time
41.46	Set 2 sleep boost step
41.47	Set 2 wake-up deviation
41.48	Set 2 wake-up delay
41.49	Set 2 tracking mode
41.50	Set 2 tracking ref selection
41.58	Set 2 increase prevention
41.59	Set 2 decrease prevention
41.60	Set 2 PID activation source
41.71	Set 2 compensation input source
41.72	Set 2 compensation input 1
41.73	Set 2 compensated output 1
41.74	Set 2 compensation input 2
41.75	Set 2 compensated output 2
41.76	Set 2 compensation non-linearity
41.80	Set 2 PID output min source
41.81	Set 2 PID output max source
41.89	Set 2 setpoint multiplier
41.90	Set 2 feedback multiplier
GROUP 43	
Brake chopper	
43.01	Braking resistor temperature
43.06	Brake chopper function
43.07	Brake chopper run permissive
43.08	Brake resistor thermal tc
43.09	Brake resistor Pmax cont
43.10	Brake resistance
43.11	Brake resistor fault limit
43.12	Brake resistor warning limit
GROUP 45	
Energy efficiency	
45.01	Saved GW hours
45.02	Saved MW hours
45.03	Saved kW hours
45.04	Saved energy
45.05	Saved money x1000
45.06	Saved money
45.07	Saved amount
45.08	CO2 reduction in kilotons
45.09	CO2 reduction in tons
45.10	Total saved CO2
45.11	Energy optimizer
45.12	Energy tariff 1
45.13	Energy tariff 2
45.14	Tariff selection
45.18	CO2 conversion factor
45.19	Comparison power
45.21	Energy calculations reset
45.24	Hourly peak power value
45.25	Hourly peak power time
45.26	Hourly total energy (resettable)
45.27	Daily peak power value (resettable)
45.28	Daily peak power time
45.29	Daily total energy (resettable)
45.30	Last day total energy
45.31	Monthly peak power value (resettable)
45.32	Monthly peak power date
45.33	Monthly peak power time
45.34	Monthly total energy (resettable)
45.35	Last month total energy
45.36	Lifetime peak power value
45.37	Lifetime peak power date
45.38	Lifetime peak power time
GROUP 46	
Monitoring/scaling settings	
46.01	Speed scaling
46.02	Frequency scaling
46.03	Torque scaling
46.04	Power scaling
46.05	Current scaling
46.06	Speed ref zero scaling
46.11	Filter time motor speed
46.12	Filter time output frequency
46.13	Filter time motor torque
46.14	Filter time power
46.21	At speed hysteresis
46.22	At frequency hysteresis
46.31	Above speed limit
46.32	Above frequency limit
46.41	kWh pulse scaling
GROUP 47	
Data storage	
47.01	Data storage 1 real32
47.02	Data storage 2 real32
47.03	Data storage 3 real32
47.04	Data storage 4 real32
47.11	Data storage 1 int32
47.12	Data storage 2 int32
47.13	Data storage 3 int32
47.14	Data storage 4 int32
47.21	Data storage 1 int16
47.22	Data storage 2 int16
47.23	Data storage 3 int16
47.24	Data storage 4 int16
GROUP 49	
Panel port communication	
49.01	Node ID number
49.03	Baud rate
49.04	Communication loss time
49.05	Communication loss action
49.06	Refresh settings
GROUP 50	
Fieldbus adapter (FBA)	
50.01	FBA A enable
50.02	FBA A comm loss func
50.03	FBA A comm loss t out
50.04	FBA A ref1 type
50.05	FBA A ref2 type
50.06	FBA A SW sel
50.07	FBA A actual 1 type
50.08	FBA A actual 2 type
50.09	FBA A SW transparent source
50.10	FBA A act1 transparent source
50.11	FBA A act2 transparent source
50.12	FBA A debug mode
50.13	FBA A control word
50.14	FBA A reference 1
50.15	FBA A reference 2
50.16	FBA A status word
50.17	FBA A actual value 1
50.18	FBA A actual value 2
GROUP 51	
FBA A settings	
51.01	FBA A type
51.02	FBA A Par2
51.03	FBA A Par3
51.04	FBA A Par4
51.05	FBA A Par5
51.06	FBA A Par6
51.07	FBA A Par7
51.08	FBA A Par8
51.09	FBA A Par9
51.10	FBA A Par10
51.11	FBA A Par11
51.12	FBA A Par12
51.13	FBA A Par13
51.14	FBA A Par14
51.15	FBA A Par15
51.16	FBA A Par16
51.17	FBA A Par17
51.18	FBA A Par18
51.19	FBA A Par19
51.20	FBA A Par20
51.21	FBA A Par21
51.22	FBA A Par22
51.23	FBA A Par23
51.24	FBA A Par24
51.25	FBA A Par25
51.26	FBA A Par26
51.27	FBA A par refresh
51.28	FBA A par table ver
51.29	FBA A drive type code
51.30	FBA A mapping file ver
51.31	D2FBAA comm status
51.32	FBA A comm SW ver
51.33	FBA A appl SW ver
GROUP 52	
FBA A data in	
52.01	FBA A data in1
52.02	FBA A data in2
52.03	FBA A data in3
52.04	FBA A data in4
52.05	FBA A data in5
52.06	FBA A data in6
52.07	FBA A data in7
52.08	FBA A data in8
52.09	FBA A data in9
52.10	FBA A data in10
52.11	FBA A data in11
52.12	FBA A data in12
GROUP 53	
FBA A data out	
53.01	FBA data out1
53.02	FBA data out2
53.03	FBA data out3
53.04	FBA data out4
53.05	FBA data out5
53.06	FBA data out6
53.07	FBA data out7
53.08	FBA data out8
53.09	FBA data out9
53.10	FBA data out10
53.11	FBA data out11
53.12	FBA data out12
GROUP 58	
Embedded fieldbus	
58.01	Protocol enable
58.02	Protocol ID
58.03	Node address
58.04	Baud rate
58.05	Panty
58.06	Communication control
58.07	Communication diagnostics
58.08	Received packets
58.09	Transmitted packets
58.10	All packets
58.11	UART errors
58.12	CRC errors
58.13	Token counter
58.14	Communication loss action
58.15	Communication loss mode
58.16	Communication loss time
58.17	Transmit delay
58.18	EFB control word
58.19	EFB status word
58.21	Device network usage
58.22	Token loop time
58.25	Control profile
58.26	EFB ref1 type
58.27	EFB ref2 type
58.28	EFB act1 type
58.29	EFB act2 type
58.30	EFB status word transparent source
58.31	EFB act1 transparent source
58.32	EFB act2 transparent source
58.33	Addressing mode
58.34	Word order
58.35	Return app error
58.40	Device object ID
58.41	Max master
58.42	Max info frames
58.43	Max APDU retries
58.44	APDU timeout
58.101	Data I/O 1
58.102	Data I/O 2
58.103	Data I/O 3
58.104	Data I/O 4
58.105	Data I/O 5
58.106	Data I/O 6
58.107	Data I/O 7
58.108	Data I/O 8
58.109	Data I/O 9
58.110	Data I/O 10
58.111	Data I/O 11
58.112	Data I/O 12
58.113	Data I/O 13
58.114	Data I/O 14
GROUP 70	
Override	
70.01	Override status
70.02	Override enable
70.03	Override activation source
70.04	Override reference source
70.05	Override direction
70.06	Override frequency
70.07	Override speed
70.10	Override enables selection
70.20	Override fault handling
70.21	Override auto reset trials
70.22	Override auto reset time
70.40	Override Log 1 Start Date
70.41	Override Log 1 Start Time
70.42	Override Log 1 End Date
70.43	Override Log 1 End Time
70.44	Override Log 1 Fault 1
70.45	Override Log 1 Fault 2
70.46	Override Log 1 Fault 3
70.47	Override Log 1 Warning 1
70.48	Override Log 1 Warning 2
70.49	Override Log 1 Warning 3
70.50	Override Log 2 Start Date
70.51	Override Log 2 Start Time
70.52	Override Log 2 End Date
70.53	Override Log 2 End Time
70.54	Override Log 2 Fault 1
70.55	Override Log 2 Fault 2
70.56	Override Log 2 Fault 3
70.57	Override Log 2 Warning 1
70.58	Override Log 2 Warning 2
70.59	Override Log 2 Warning 3
70.60	Override Log 3 Start Date
70.61	Override Log 3 Start Time
70.62	Override Log 3 End Date
70.63	Override Log 3 End Time
70.64	Override Log 3 Fault 1
70.65	Override Log 3 Fault 2
70.66	Override Log 3 Fault 3
70.67	Override Log 3 Warning 1
70.68	Override Log 3 Warning 2
70.69	Override Log 3 Warning 3
GROUP 71	
External PID1	
71.01	External PID act value
71.02	Feedback act value
71.03	Setpoint act value
71.04	Deviation act value
71.06	PID status word
71.07	PID operation mode
71.08	Feedback 1 source
71.11	Feedback filter time
71.14	Setpoint scaling
71.15	Output scaling
71.16	Setpoint 1 source
71.19	Internal setpoint sel1
71.20	Internal setpoint sel2
71.21	Internal setpoint 1
71.22	Internal setpoint 2
71.23	Internal setpoint 3
71.26	Setpoint min
71.27	Setpoint max
71.31	Deviation inversion
71.32	Gain
71.33	Integration time

Complete Parameters List (continued)

71.34	Derivation time
71.35	Derivation filter time
71.36	Output min
71.37	Output max
71.38	Output freeze enable
71.39	Deadband range
71.40	Deadband delay
71.58	Increase prevention
71.59	Decrease prevention
71.62	Internal setpoint actual
GROUP 72	
External PID2	
72.01	External PID act value
72.02	Feedback act value
72.03	Setpoint act value
72.04	Deviation act value
72.06	PID status word
72.07	PID operation mode
72.08	Feedback 1 source
72.11	Feedback filter time
72.14	Setpoint scaling
72.15	Output scaling
72.16	Setpoint 1 source
72.19	Internal setpoint sel1
72.20	Internal setpoint sel2
72.21	Internal setpoint 1
72.22	Internal setpoint 2
72.23	Internal setpoint 3
72.26	Setpoint min
72.27	Setpoint max
72.31	Deviation inversion
72.32	Gain
72.33	Integration time
72.34	Derivation time
72.35	Derivation filter time
72.36	Output min
72.37	Output max
72.38	Output freeze enable
72.39	Deadband range
72.40	Deadband delay
72.58	Increase prevention
72.59	Decrease prevention
72.62	Internal setpoint actual
GROUP 73	
External PID3	
73.01	External PID act value
73.02	Feedback act value
73.03	Setpoint act value
73.04	Deviation act value
73.06	PID status word
73.07	PID operation mode
73.08	Feedback 1 source
73.11	Feedback filter time
73.14	Setpoint scaling
73.15	Output scaling
73.16	Setpoint 1 source
73.19	Internal setpoint sel1
73.20	Internal setpoint sel2
73.21	Internal setpoint 1
73.22	Internal setpoint 2
73.23	Internal setpoint 3
73.26	Setpoint min
73.27	Setpoint max
73.31	Deviation inversion
73.32	Gain
73.33	Integration time
73.34	Derivation time
73.35	Derivation filter time
73.36	Output min
73.37	Output max
73.38	Output freeze enable
73.39	Deadband range
73.40	Deadband delay
73.58	Increase prevention
73.59	Decrease prevention
73.62	Internal setpoint actual
GROUP 74	
External PID4	
74.01	External PID act value
74.02	Feedback act value
74.03	Setpoint act value
74.04	Deviation act value
74.06	PID status word
74.07	PID operation mode
74.08	Feedback 1 source
74.11	Feedback filter time
74.14	Setpoint scaling
74.15	Output scaling
74.16	Setpoint 1 source
74.19	Internal setpoint sel1
74.20	Internal setpoint sel2
74.21	Internal setpoint 1
74.22	Internal setpoint 2
74.23	Internal setpoint 3
74.26	Setpoint min
74.27	Setpoint max
74.31	Deviation inversion
74.32	Gain
74.33	Integration time
74.34	Derivation time
74.35	Derivation filter time
74.36	Output min
74.37	Output max
74.38	Output freeze enable
74.39	Deadband range
74.40	Deadband delay
74.58	Increase prevention
74.59	Decrease prevention
74.62	Internal setpoint actual
GROUP 76	
PFC configuration	
76.01	PFC status
76.02	Multi-pump system status
76.05	Measured level
76.06	Measured level %
76.07	LC speed ref
76.11	Pump/fan status 1
76.12	Pump/fan status 2
76.13	Pump/fan status 3
76.14	Pump/fan status 4
76.21	Multi-pump configuration
76.22	Multi-pump node number
76.23	Master Enabled
76.24	IPC communications port
76.25	Number of motors
76.26	Min number of motors allowed
76.27	Max number of motors allowed
76.30	Start point 1
76.31	Start point 2
76.32	Start point 3
76.41	Stop point 1
76.42	Stop point 2
76.43	Stop point 3
76.50	LC full speed point
76.51	LC level source
76.52	LC level unit
76.53	LC efficient speed
76.54	LC max time at level
76.55	Start delay
76.56	Stop delay
76.57	PFC speed hold on
76.58	PFC speed hold off
76.59	PFC contactor delay
76.60	PFC ramp acceleration time
76.61	PFC ramp deceleration time
76.62	IPC smooth acceleration time
76.63	IPC smooth deceleration time
76.70	PFC Autochange
76.71	PFC Autochange interval
76.72	Maximum wear imbalance
76.73	Autochange level
76.74	Autochange auxiliary PFC
76.76	Max stationary time
76.77	Pump priority
76.81	PFC 1 interlock
76.82	PFC 2 interlock
76.83	PFC 3 interlock
76.84	PFC 4 interlock
76.90	LC low level switch
76.91	LC high level switch
76.92	LC low level switch
76.93	LC high level action
76.95	Regulator bypass control
76.101	IPC parameter synchronization
76.102	IPC synchronization settings
76.105	IPC synchronization checksum
GROUP 77	
PFC maintenance and monitoring	
77.10	PFC runtime change
77.11	Pump/fan 1 running time
77.12	Pump/fan 2 running time
77.13	Pump/fan 3 running time
77.14	Pump/fan 4 running time
GROUP 80	
Flow calculation	
80.01	Actual flow
80.02	Actual flow percentage
80.03	Actual flow
80.04	Specific energy
80.05	Estimated pump head
80.11	Flow feedback 1 source
80.12	Flow feedback 2 source
80.13	Flow feedback function
80.14	Flow feedback multiplier
80.15	Maximum flow
80.16	Minimum flow
80.17	Maximum flow protection
80.18	Minimum flow protection
80.19	Flow check delay
80.29	Total flow reset
GROUP 81	
Sensor settings	
81.01	Actual inlet pressure
81.02	Actual outlet pressure
81.10	Inlet pressure source
81.11	Outlet pressure source
81.12	Sensors height difference
81.20	Pressure unit
81.21	Flow unit
81.22	Length unit
81.23	Density unit
GROUP 82	
Pump protection	
82.20	Dry run protection
82.21	Dry run source
82.25	Soft pipe fill supervision
82.26	Time-out limit
82.30	Outlet minimum pressure protection
82.31	Outlet minimum pressure warning
82.32	Outlet minimum pressure fault
82.35	Outlet maximum pressure protection
82.37	Outlet maximum pressure warning
82.38	Outlet maximum pressure fault
82.40	Inlet minimum pressure protection
82.41	Inlet minimum pressure warning
82.42	Inlet minimum pressure fault
82.45	Pressure check delay
GROUP 84	
Advanced damper control	
84.01	Advanced damper configuration
84.02	Damper control status word
84.03	DA damper open input
84.04	DA damper open timeout
84.05	DA damper open timeout action
84.06	DA damper closed input
84.07	DA damper closed input timeout
84.08	DA damper closed input timeout action
84.13	OA damper open input
84.14	OA damper open timeout
84.15	OA damper open timeout action
84.16	OA damper closed input
84.17	OA damper closed timeout
84.18	OA damper closed timeout action
GROUP 95	
HW configuration	
95.01	Supply voltage
95.02	Adaptive voltage limits
95.03	Estimated AC supply voltage
95.04	Control board supply
95.15	Special HW settings
95.20	HW options word 1
95.21	HW options word 2
GROUP 96	
System	
96.01	Language
96.02	Pass code
96.03	Access level status
96.04	Macro select
96.05	Macro active
96.06	Parameter restore
96.07	Parameter save manually
96.08	Control board boot
96.10	User set status
96.11	User set save/load
96.12	User set I/O mode in1
96.13	User set I/O mode in2
96.16	Unit selection
96.20	Time sync primary source
96.51	Clear fault and event logger
96.70	Disable adaptive program
GROUP 97	
Motor control	
97.01	Switching frequency reference
97.02	Minimum switching frequency
97.03	Slip gain
97.04	Voltage reserve
97.05	Flux braking
97.08	Optimizer minimum torque
97.09	Switching frequency mode
97.10	Signal injection
97.11	TR tuning
97.13	IR compensation
97.15	Motor model temperature adaptation
97.16	Stator temperature factor
97.17	Rotor temperature factor
97.20	U/F Ratio
GROUP 98	
User motor parameters	
98.01	User motor model mode
98.02	Rs user
98.03	Rr user
98.04	Lm user
98.05	SigmaL user
98.06	Ld user
98.07	Lq user
98.08	PM flux user
98.09	Rs user SI
98.10	Rr user SI
98.11	Lm user SI
98.12	SigmaL user SI
98.13	Ld user SI
98.14	Lq user SI
GROUP 99	
Motor data	
99.03	Motor type
99.04	Motor control mode
99.06	Motor nominal current
99.07	Motor nominal voltage
99.08	Motor nominal frequency
99.09	Motor nominal speed
99.10	Motor nominal power
99.11	Motor nominal cos φ
99.12	Motor nominal torque
99.13	ID run requested
99.14	Last ID run performed
99.15	Motor polepairs calculated
99.16	Motor phase order

Specifications

SCOPE

TABLE 24 - CONFIGURATION AVAILABILITY

DESCRIPTION	TYPE CODE	AYK550	AYK580
Bypass with fused disconnect	CF	YES	YES
Non-bypass with fused disconnect	PF	YES	YES
Bypass with non-fused disconnect	CD	YES	NO
Non-bypass with non-fused disconnect	PD	YES	NO

STANDARD PACKAGED DRIVES - FUNCTION

Non-bypass with fused disconnect (PF)

This product includes the AYK580-01 base drive with a fused rotary through-the-door input disconnect switch.

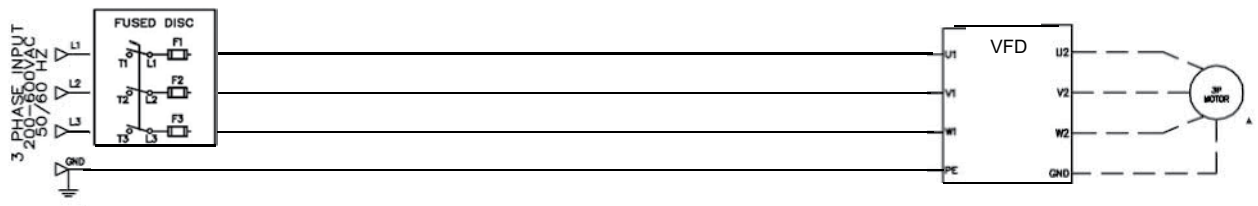
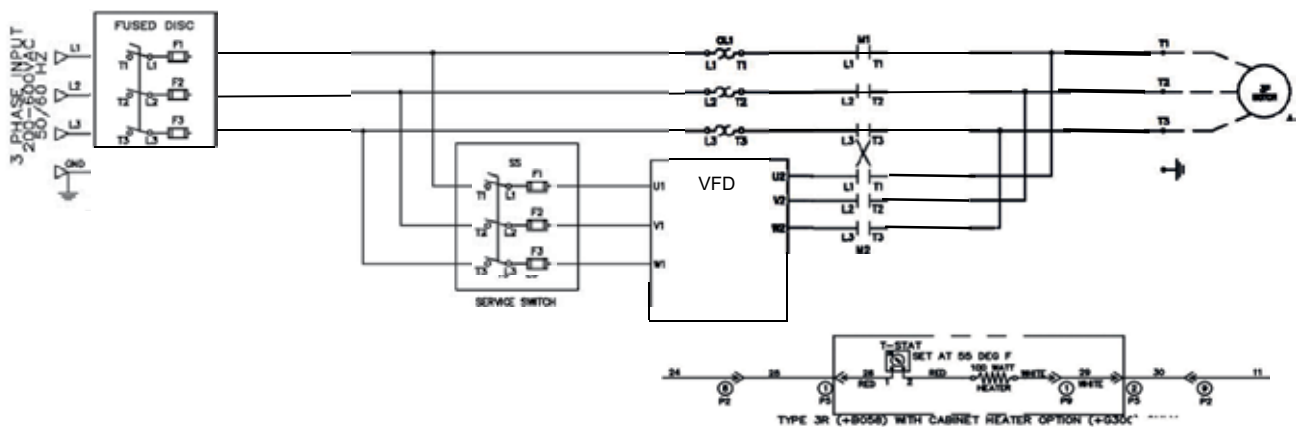

FIGURE 49 - NON-BYPASS WITH FUSED DISCONNECT (PF) CIRCUIT DIAGRAM

Electrical components

- Fused disconnect with Fast Acting class CC (R1 – R?) or Fast Acting J Fusing / DFJ fuses
- Variable frequency drive, AYK580
- Three phase motor (supplied by JCI)

Classic bypass with fused disconnect (CF)

This product includes the AYK580-01 base drive with a fused rotary through-the-door input disconnect switch plus a two-contactor (mechanically interlocked) bypass.

FIGURE 50 - CLASSIC BYPASS WITH FUSED DISCONNECT (CF) DIAGRAM

Specifications (continued)

Electrical components

- Fused disconnect with class J fuses
- Service switch with Fast Acting class CC (R1 – R?) or Fast Acting J Fusing / DFJ fuses
- Variable frequency drive, AYK580
- Two contactors, mechanically or electrically interlocked (ABB Type AF)
- Electronic overload relay (ABB Type EF)
- Three phase motor (supplied by JCI)

Standard Packaged Drives - Options

Options for the full line of products is shown below.

IMPORTANT: Some options will be included in all cases as noted.

CODE	DESCRIPTION	COMMENT
B058	UL Type 3R	Plus Code Required
G418	Alternate motor overload - one (1) standard rating below the standard motor overload for that unit (Bypass units only)	Optional on an SQ Basis If Required
G419	Alternate motor overload - two (2) standard ratings below the standard motor overload for that unit (Bypass units only)	Optional on an SQ Basis If Required
G441	Alternate motor overload - three (3) standard ratings below the standard motor overload for that unit (Bypass units only)	Optional on an SQ Basis If Required

Note: Depending on how the new electronic overloads line up with drive/motor amperages, the +G418, +G419 and +G441 option codes may not be required.

Special Order Packaged Drives

Definition

A “special order package” is defined as a unit that deviates in any way from the standard package as defined above.

Service Parts

Spare parts

ABB maintains a stock of the parts that may require replacement over the life of the drive unit. This includes fans, relays, fuses, etc. Contact ABB Drive Services for pricing and delivery.

Replacement Parts

Availability

Replacement parts are parts that do not normally fail over the life of the drive unit. This includes doors, covers, hinges, wires harnesses, etc. While ABB maintains a stock of these parts it is for use by the ABB factory to build new units. Availability as a separate replacement part to JCI may be limited.

Cabinet Doors

ABB purchases doors as part of a kit for a complete cabinet. Therefore, available as a replacement part is only as a complete cabinet. When a door is requested, ABB will supply a complete cabinet without electrical components. However, for bypass units, selector switches mounted on the door will be included.

Documentation

Each Configured unit will be shipped with electrical schematics supplied in a plastic bag within the enclosure.

Specifications (continued)

Overall Packaged Drive Specifications

TABLE 25 - OVERALL PACKAGED DRIVE SPECIFICATIONS

PACKAGE PRODUCT TYPES	
PF:	Drive with main fusible disconnect switch
CF:	Drive, 2 contactor classic bypass, main fusible disconnect, fusible drive input service switch, control power transformer and 2 selector switches (DRIVE-Off-BYPASS and HAND-OFF-AUTO) for control
PRODUCT OPTION CODES	
B058	UL Type 3R enclosure
G418	Motor overload relay, 1 size smaller (SQ Basis ONLY)
G419	Motor overload relay, 2 sizes smaller (SQ Basis ONLY)
G441	Motor overload relay, 3 sizes smaller (SQ Basis ONLY)
AGENCY APPROVALS	
UL508C:	VFD Only
UL508A:	Yes
cUL:	Yes
CSA	No – Available as a special quote request if required.
PACKAGED DRIVE NAME-PLATE RATINGS	
Short Circuit Current Rating:	100,000 RMS for all symmetrical Amperes (see drive specification / Exception: (575V SCCR 5KA)
INPUT:	
Voltage:	208 to 230 VAC 3-phase $\pm 10\%$, 60 Hz; 460 VAC 3-phase $\pm 10\%$, 60 Hz; 575 VAC 3-phase $\pm 10\%$, 60 Hz 380V/400/ 415 VAC $\pm 10\%$, 50/60 Hz (SQ Required / Available Upon Request)
FLA:	To be provided
Frequency:	60 Hz unit Frequency Tolerance 57-63 Hz 50/60 Hz unit Frequency Tolerance 48-63 Hz
OUTPUT:	
Voltage:	208 to 230 VAC 3-phase $\pm 10\%$, 60 Hz; 460 VAC 3-phase $\pm 10\%$, 60 Hz 380V/400/ 415 VAC $\pm 10\%$, 50/60 Hz; 460 VAC 3-phase $\pm 10\%$ 60 Hz, 575 VAC 3-phase $\pm 10\%$, 60 HZ
FLA:	See ratings table
Frequency:	See drive specifications
INPUT SUPPLY	
Input Voltage (U1):	208 to 230 VAC 3-phase $\pm 10\%$, 60 Hz; 460 VAC 3-phase $\pm 10\%$, 60Hz;380/400/ 415VAC $\pm 10\%$, 50/60 Hz; 575 VAC 3-phase $\pm 10\%$, 60 Hz
Frequency:	60 Hz unit Frequency Tolerance 57-63 Hz 50/60 Hz unit Frequency Tolerance 48-63 Hz
Line Limitations:	Max +/-3% of nominal phase to phase input voltage
Fundamental Power Factor (cosj):	0.98 at nominal load
LOAD CHARACTERISTICS	
Application:	HVAC Fans Factory Mounted
MOTOR	
HP:	1 to 75 HP at 208/ 230V; 1 to 75 HP at 380/400/415V; 1 to 150 HP at 460V, 1 to 125 HP at 575V
Design Type:	NEMA B Standard Efficiency
3-Phase FLA:	Less than or equal to the panel rating

Specifications (continued)

TABLE 23 - OVERALL PACKAGED DRIVE SPECIFICATIONS (CONT'D)

I peak (amps):	Estimating 6 times Motor FLA (with motor FLA not exceeding panel max amps) for a motor across the line start in bypass
Load Profile Ramp / Starting Time (sec):	We have assumed a 15 second start time

TABLE 26 - ENCLOSURE CHARACTERISTICS (UL TYPE 1)

FEATURE	DESCRIPTION
UL Enclosure Protection Class:	UL Type (NEMA) 1
Material:	
Type:	Galvanized Steel
Gauge:	
Enclosure:	14 gauge
Mounting Plate:	12 gauge
Internal Component Back plate:	12 gauge
Air Dams:	16 gauge
Remaining:	14 gauge
Assembly Type:	Bolt, Screw, & Rivet
Ventilation:	Forced air via VFD
Accessories:	
Drip Shield	No
Louvers	No
Heater	No
Drain Plug	No
Thermostat	No
Keypad Shield	No
Solar Shield – Door	No
Top Drip Shield	No
Conduit:	
Location/Placement:	
Entry	Rear (factory mount) / Bottom (field mount)
Exit	Rear (factory mount) / Bottom (field mount)
Knockout Dimensions:	
R1- R6:	Varies by type and rating. See dimension drawings.
Door:	
Type:	Removable
Hinge:	2 (R1/R2), 3 (R3), or 4 (R4-R7) loose joint
Closure:	2 (R1-R3) or 3 (R4-R7) non-locking quarter-turn Latches
Lifting Configurations:	Type PF Wall Mounting Tabs R1-R7 Type CF lifting holes R1-R7

Specifications (continued)

TABLE 27 - ENCLOSURE CHARACTERISTICS (UL TYPE 3R)

FEAUTRE	DESCRIPTION
UL Enclosure Protection Class:	UL Type (NEMA) 3R (+B058 option)
Material:	
Type:	Cold rolled commercial quality steel per ASTM Specification A-1008/A-1008M
Gauge:	
Enclosure:	14 gauge
Internal Component Back plate:	12 gauge
Air Dams:	16 gauge
Remaining:	14 gauge
Assembly Type:	Weld & rivet
Ventilation:	Forced air via VFD
Coating:	
Type:	Powder coat
Thickness:	3.0-3.5 mils
Surfaces/Components:	Enclosure surfaces powder coated
Color Description & Code:	JCI Champagne Brown
Certifications:	UL Recognized
Accessories:	
Drip Shield	Yes (R1-R6 frames)
Louvers	No
Heater	Yes
Drain Plug	No
Thermostat	Yes
Keypad Shield	Yes
Solar Shield – Door	Standard on frames R4-R7
Conduit:	
Location/Placement:	
Entry	Rear (factory mount) / Bottom (field mount)
Exit	Rear (factory mount) / Bottom (field mount)
Knockout Dimensions:	
R1- R6:	Varies by type and rating. See dimension drawings.
Door:	
Type:	Removable
Hinge:	2 (R1/R2), 3 (R3), or 4 (R4-R7) loose joint
Closure:	2 (R1-R3) or 3 (R4-R7) non-locking quarter-turn latches
Lifting Configurations:	Type PF Wall Mounting Tabs R1-R7 Type CF lifting holes R1-R7

Specifications (continued)

TABLE 28 - COMMON FEATURES IN UL TYPE 1 AND 3R

FEATURE	DESCRIPTION
Controls	
Motor Control:	VFD (all types) or (CF) 2 Contactor Classic Bypass with Electronic Coil (ABB AF Series Contactors)
Control Mode:	Variable torque
Operating Mode:	Keypad (PF/CF) & 2-Wire Bypass (CF)
Speed Command Reference:	0-10 Vdc
Control Switches:	Hand-Off-Auto & Drive-Off-Bypass (CF)
Contactors:	Bypass & Drive Output Mechanically Interlocked (CF)
Overload:	
Up to 80 Amp:	Electronic Class 10, 20 or 30 (Default Set for Class 20)
Greater than 80 Amp:	Current Transformer/Overload (electronic class 10, 20 or 30) Combination
Control Transformer:	Primary voltage selectable 208/230/460VAC @ 60Hz or 380V/400V @ 50/60 Hz or 575 VAC @ 60 Hz. ABB reserves the right to select the kVA rating on a transformer to meeting technical specifications
Control Inputs:	
PF:	Run, constant speed, safeties (all dry contact)
CF:	External speed reference, safeties (up to 2), Run time clock
Control Outputs:	fault (relay), frequency (analog & relay), running (relay)
Disconnecting Means	
Disconnect:	Rotary thru door fused, open-lockable door closed
Service Switch:	Rotary disconnect accessible from inside enclosure.
Branch circuit protection:	PF, CF max fuse size based on a target of 175% of drive FLA subject to ABB UL File max branch fuse specifications required to achieve short circuit current rating
Internal Wiring	
Type:	THHN, MTW, or silicon rubber UL3213
Wire marking specification:	Slip on markers or printed on wire
Wire color specification:	
Power	Black, size per UL508A Table 28.1
AC Control	Red (AC line), white (AC neutral), 16 AWG
DC Control	Blue (DC +supply), blue (common), 20 AWG
Environmental	
Ambient Temperature:	-15 deg C to 40 deg C (Derate required for up to 50 degree C required)
Storage Temperature:	-40 deg C to 70 deg C
Humidity:	<95% non-condensing
Altitude:	up to 1000m (3300 ft.) without derate (Derate required for high altitude)
Packaging	
UL Type 1 - PF	Corrugated paperboard box with plywood & insert internal (R1, R2) Wood pallet base & cardboard cover (R3-R6)
UL Type 1 - CF	Wood pallet base, corrugated paperboard wrapper and cover
UL Type 3R- PF/CF	Wood pallet base, corrugated paperboard wrapper and cover
Product Labeling	
General:	Per UL508A

Specifications (continued)

TABLE 26 - COMMON FEATURES IN UL TYPE 1 AND 3R (CONT'D)

FEATURE	DESCRIPTION
Exterior:	Warnings (risk of fire / shock, discharge wait)
	Caution (foreign voltage), & Controls (see controls section above)
Interior:	UL, UL Enclosure Type, & Ratings
Customized Base Drive	AYK580-01 brand labeled ACH580 with customized control panel

DEFINITION OF NEMA AND IEC ENVIRONMENTAL RATINGS

NEMA and IEC environmental ratings can be confusing. The following is a summary of the rating definitions and recommendations for application of each type supported by the AYK580 AC Drive product family.

NEMA 1, UL type 1

Indoor use primarily to provide a degree of protection against limited amounts of falling dirt

IP 2 1

(2) Protected against solid foreign objects of 12.5 mm diameter and greater

(1) Protected against certically falling water drops

Recommendation

Installation in clean environment such as clean room or in another enclosure with higher degree of protection.

NEMA 12, UL type 12

Indoor use primarily to provide a degree of protection against circulating dust, falling dirt, and dropping non-corrosive liquids.

IP 5 4

(5) Ingress of dust is not totally prevented, but dust does not penetrate in a quantity to interfere with satisfactory operation of the apparatus or to impair safety.

(4) Water splashed against the enclosure from any direction does not have harmful effects.

Recommendation

Installation in environments with moderate to significant dust and contaminant particles. Acceptable for most applications on factory floors where dust is present but spraying liquids are not. Regular preventative maintenance for filter changing or cleaning. Inspect drive for dust or particle build up that may limit cooling in the future, clean as needed.

NEMA 3R, UL type 3R

Either indoor or outdoor use to provide a degree of protection against falling dirt, rain, sleet, and snow; and that will be undamaged by the external formation of ice on the enclosure.

IP 2 4

(2) Protected against solid foreign objects of 12.5mm diameter and greater

(4) Water splashed against the enclosure from any direction shall have no harmful effects

Recommendation

Installation in outdoor environments where rain and other precipitates are commonly present. Also suitable for indoor installation where dripping or splashing water is present. Not recommended where significant dust and contaminant particles are present.

Appendix A

WIRING DIAGRAMS

TABLE 29 - WIRING DIAGRAMS

	DESCRIPTION	DRAWING NUMBER	PAGE
01	Base Drive with NEMA 1 conduit box as standard AYK580-01 Base Drive - R1 to R9 connections and wiring	#3AXD10000404024	103 - 105
PF	Base Drive with fused input disconenct AYK580 electrical drawings NON-BYPASS, N1 and N3R Special note: The same drawing is used for both NEMA 1 and NEMA 3R	#3AXD50000490134	108
CF	Base Drive with main fuse disconnect Classic 2 contactor bypass and drive isolation fast acting fused service switch switches AYK580 electrical drawings BYPASS, N1 and N3R Special note: The same drawing is used for both NEMA 1 and NEMA 3R	#3AXD50000489268	109

DEFAULT CONTROL CONNECTIONS FOR THE HVAC DEFAULT

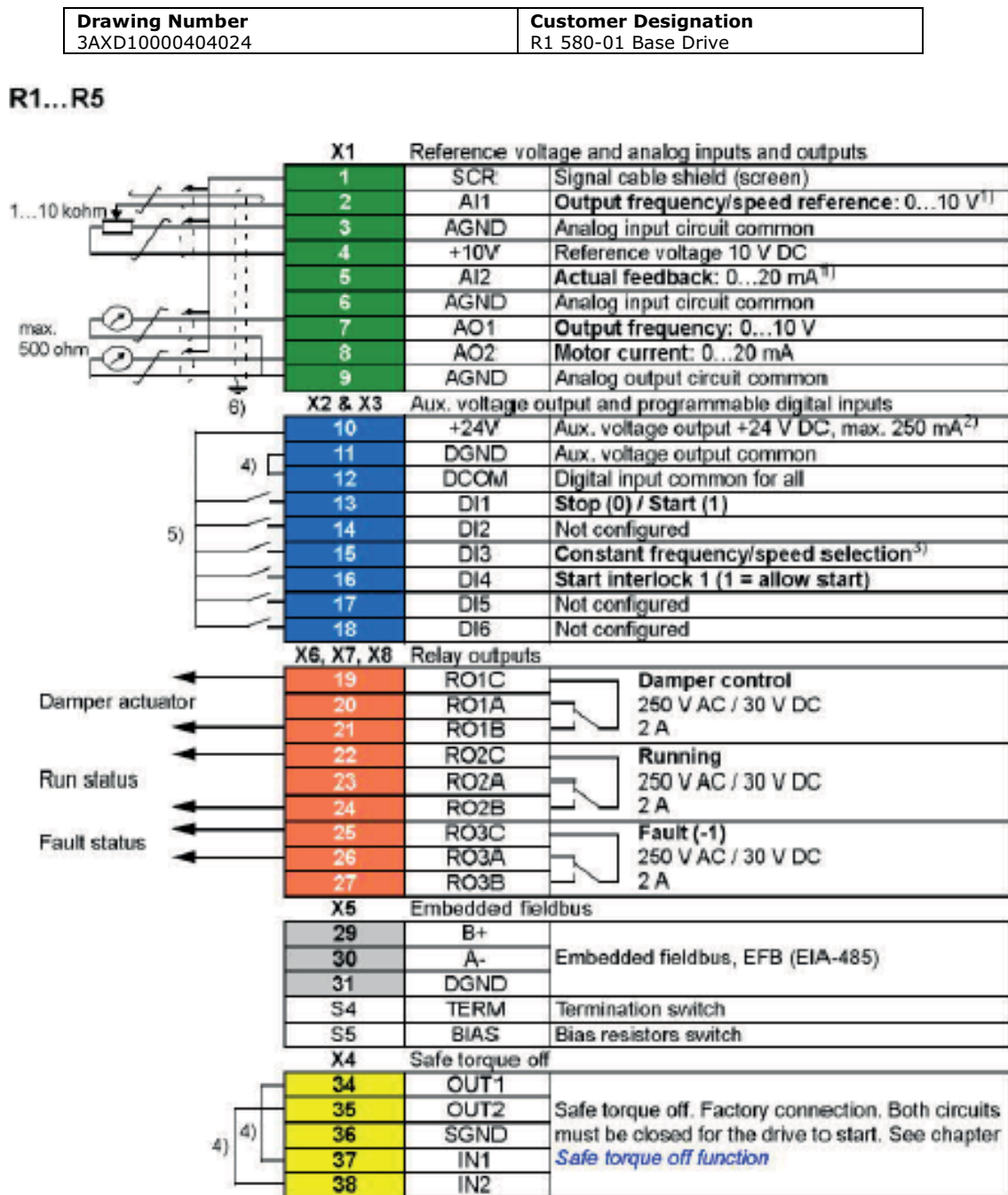

FIGURE 51 - DEFAULT CONTROL CONNECTIONS FOR THE HVAC DEFAULT

- Total load capacity of the auxiliary voltage output +24 VAC (X2:10) is 6.0 W (250 mA/24 VDC).
- Digital inputs DI1...DI5 also support 10 VAC to 24 VAC.
- Wire sizes:
 - 0.2...2.5mm² (24...14 AWG); terminals +24 V, DGND, DCOM, B+, A-, DGND, Ext. 24 V.
 - 0.14...1.5mm² (26...16 AWG); terminals DI, AI, AO, AGND, RO, STO
- Tightening torques: 0.5...0.6 N·m (0.4 lbf·ft)

EXTERNAL CONTROL CONNECTION TERMINALS, FRAMES R1...R5

The layout of the external control connection terminals of the R1 frame is shown in the following figure. Layout of the external control connection terminals is identical in frames R1...R5, but the location of the control board with the terminals is different in frames R3...R5.

Drawing Number
3AXD10000404024

Customer Designation
R1 580-01 Base Drive

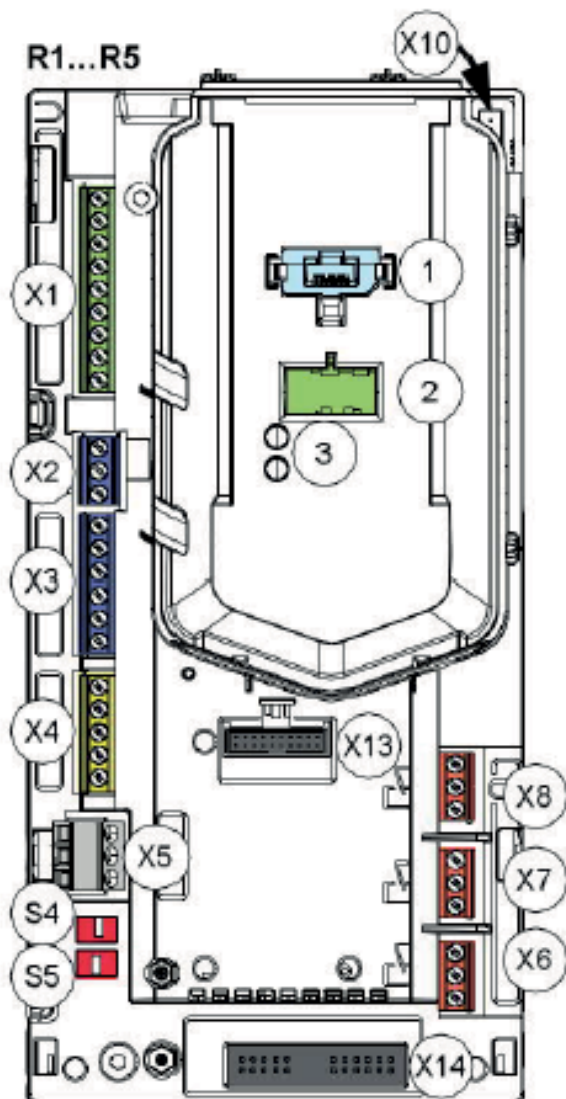

	Description
X1	Analog inputs and outputs
X2	Aux. voltage output
X3	Programmable digital inputs
X4	Safe torque off connection
X5	Embedded fieldbus
X6	Relay output 3
X7	Relay output 2
X8	Relay output 1
X10	Auxiliary fan connection (IP55)
X13	Option slot 1 (fieldbus adapter modules)
X14	Option slot 2 (I/O extension modules)
S4, S5	Termination switch (S4), bias resistor switch (S5), see section Switches See Switch Orientations Below
1	Panel Port (Control Panel Connection)
2	Cold configuration connection. This connector is used with the CCA-01 configuration adapter.
3	Power OK and Fault LEDs. See section LEDs below

FIGURE 52 - EXTERNAL CONTROL CONNECTION TERMINALS, FRAMES R1...R5

DEFAULT CONTROL CONNECTIONS FOR R6...R9

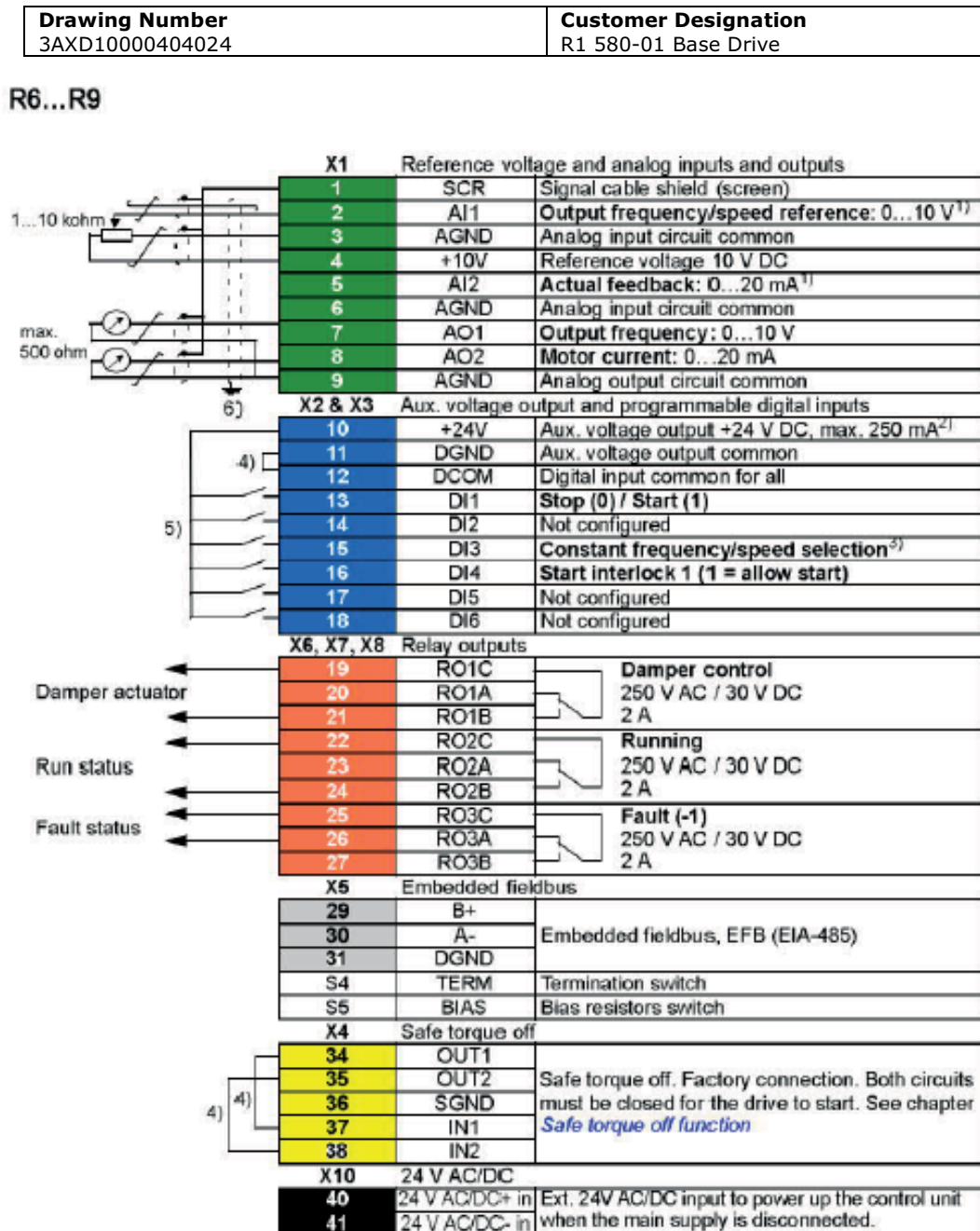

FIGURE 53 - DEFAULT CONTROL CONNECTIONS FOR R6...R9

- Total load capacity of the auxiliary voltage output +24 V (X2:10) is 6.0 W (250 mA/24 VDC).
- Digital inputs DI1...DI5 also support 10 VAC to 24 VAC
- Wire sizes: 0.14...2.5mm² (26...16 AWG): All terminals
- Tightening torques: 0.5... 0.6 N·m (0.4 lbf·ft)

EXTERNAL CONTROL CONNECTION TERMINALS, FRAMES R6...R9

The layout of the external control connection terminals of frames R6...R9 is shown in the following figure:

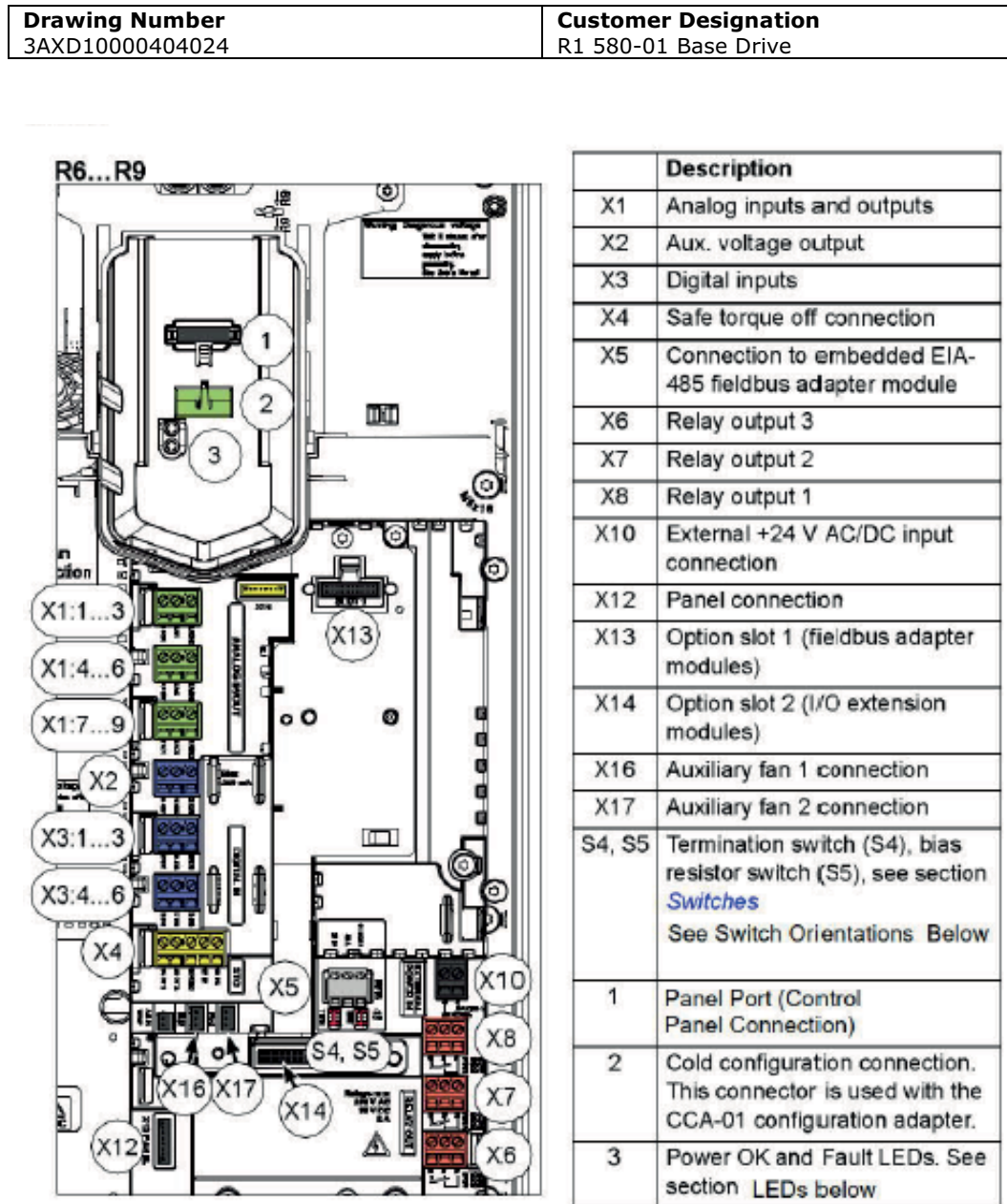

FIGURE 54 - EXTERNAL CONTROL CONNECTION TERMINALS, FRAMES R6...R9

WARNING: Do not connect the +24 VAC cable to the control board ground when the control board is powered using an external 24 VAC supply.

Drawing Number 3AXD10000404024	Customer Designation R1 580-01 Base Drive
--	---

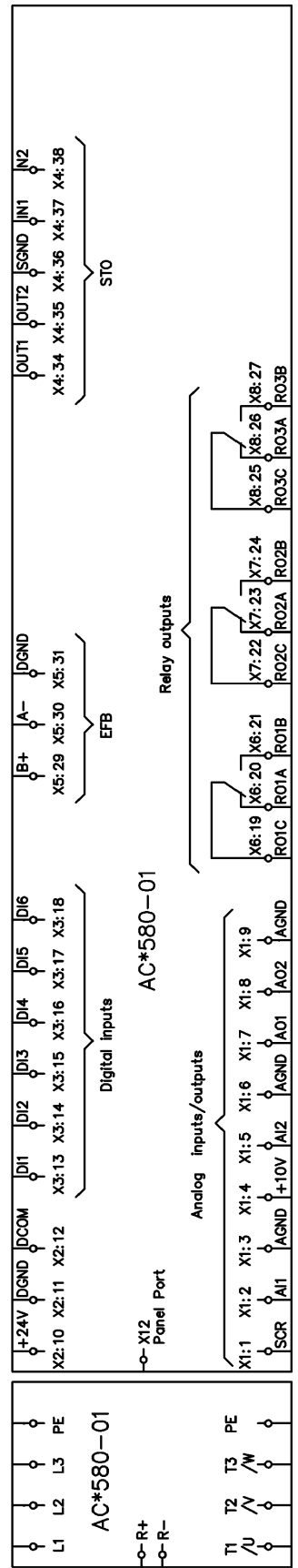

FIGURE 55 - WIRING CONNECTION FOR R0...R3 ACS580-01, ACH580-01, ACQ580-01

OVERVIEW OF POWER AND CONTROL CONNECTIONS

The following logical diagram shows the power connections and control interfaces of the drive.

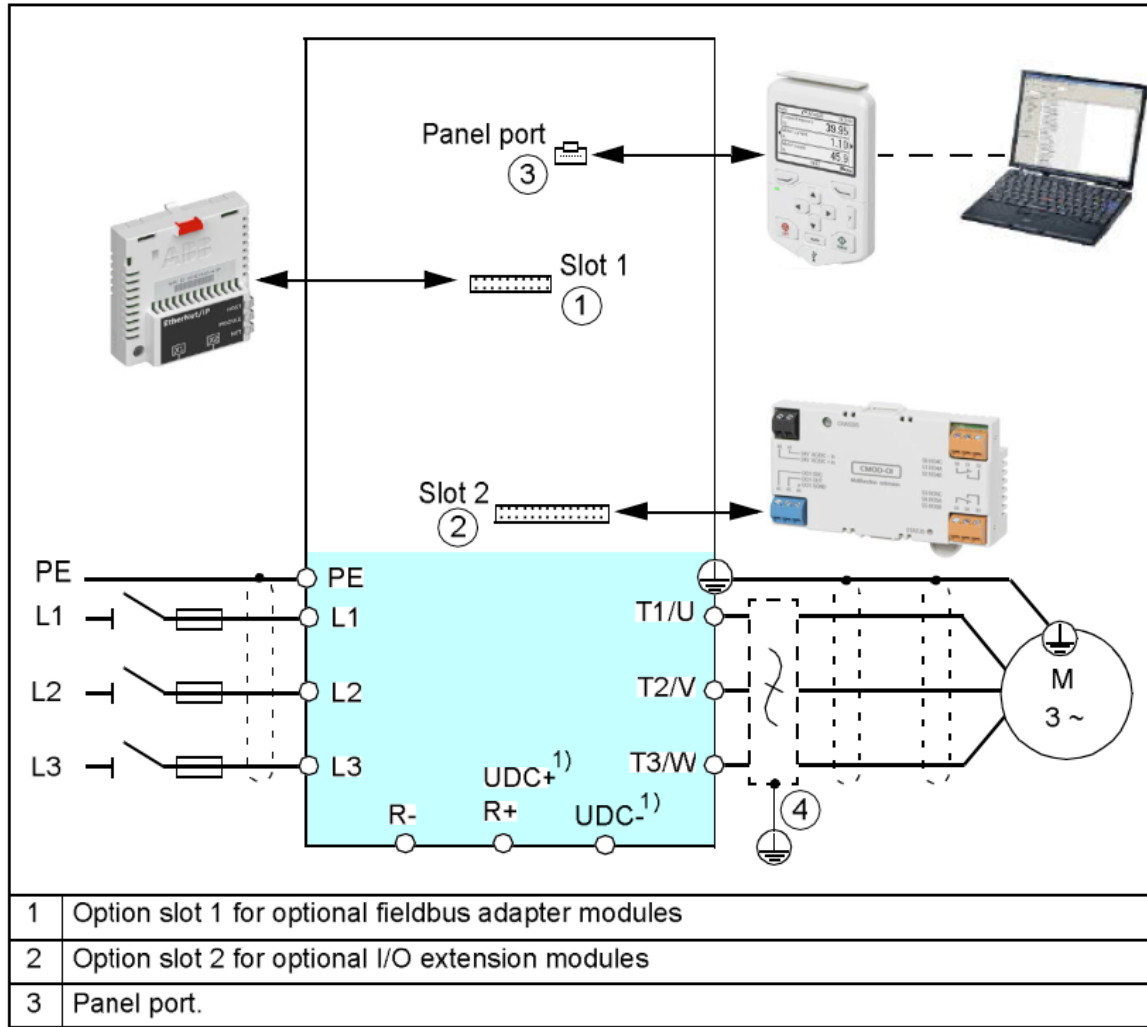





FIGURE 56 - POWER CONNECTIONS AND CONTROL INTERFACES

Switches and LEDs

Switches

TABLE 30 - SWITCHES

SWITCH	DESCRIPTION	POSITION	
S4 (TERM)	EFB link termination. Must be set to the terminated (ON) position when the drive is the first or last unit on the link.		Bus not terminated
			Bus terminated
S5 (BIAS)	Activated on the biasing voltages to the bus. One (and only one) device, preferably at the end of the bus must have the bias on.		Bias off (default)
			Bias on

LEDS

Drive LEDs

There is a green POWER and a red FAULT LED on the front of the drive. They are visible through the panel cover but invisible if a control panel is attached to the drive. The following table describes the drive LED indications

Drive LEDs POWER and FAULT, on the front of the drive, under the control panel/panel cover

If a control panel is attached to the drive, switch to remote control (otherwise a fault is generated), and then remove the panel to be able to see the LEDs.

TABLE 31 - LEDES

LEDS OFF	LED LIT AND STEADY		LED BLINKING	
No power	Green (POWER)	Power supply on the board OK	Green (POWER)	Blinking: Drive in an alarm state Blinking for one second:
	Red (FAULT)	Active fault in the drive. To reset the fault, press RESET from the control panel or switch off the drive power.	Red (FAULT)	Drive selected on the control panel when multiple drives are connected to the same panel bus
				Active fault in the drive. To reset the fault, switch off the drive power.

3AXD50000490134

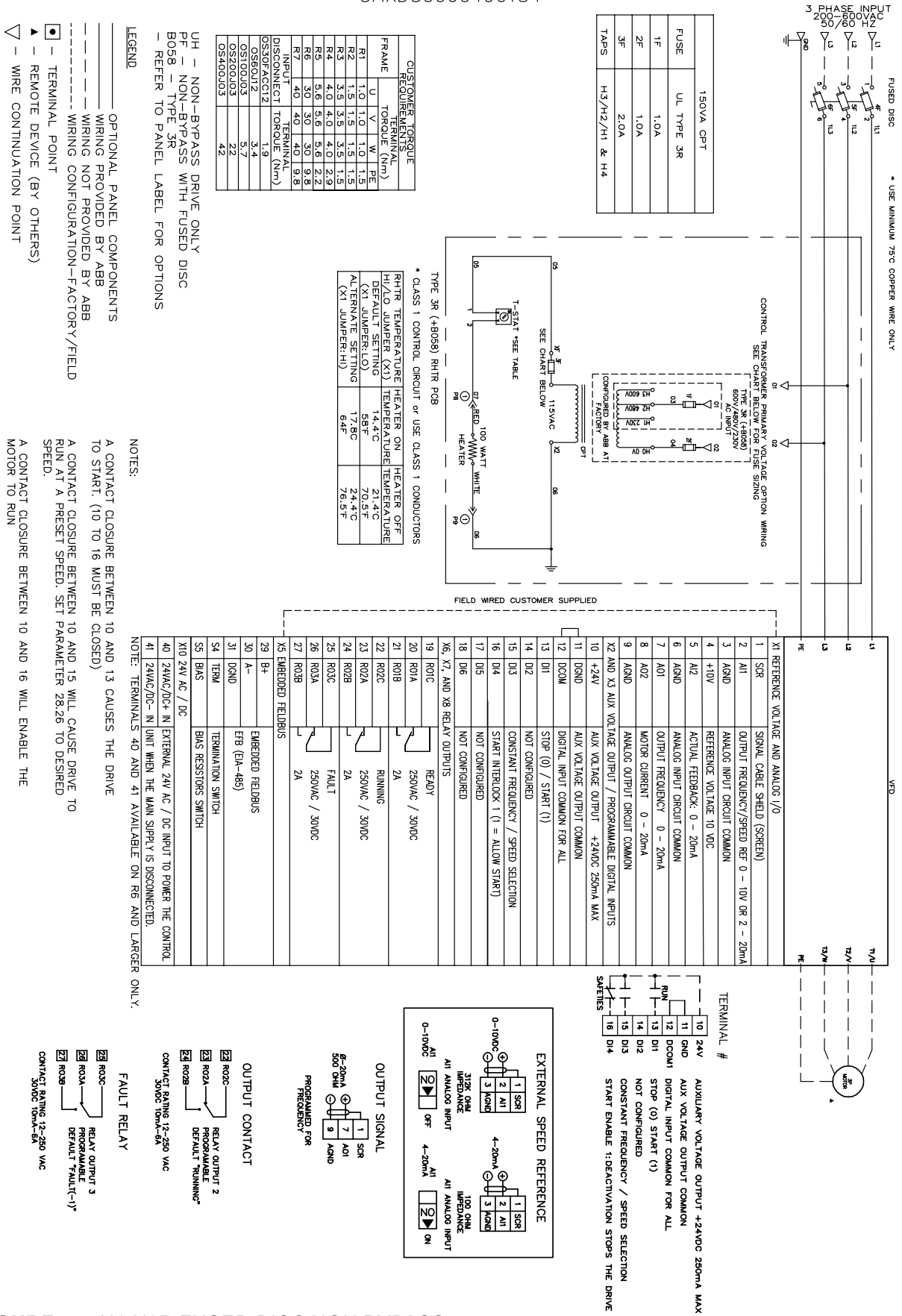

150VA CPT	
FUSE	UL TYPE 3R
1F	1.0A
2F	1.0A
3F	2.0A
TAPS	H3/H2/H1 & H4

CUSTOMER TORQUE REQUIREMENTS			
FRAME	U	V	W
R1	1.0	1.0	1.0
R2	1.5	1.5	1.5
R3	3.5	3.5	3.5
R4	4.0	4.0	4.0
R5	5.6	5.6	5.6
R6	3.0	3.0	3.0
R7	4.0	4.0	4.0
R8	4.0	4.0	9.8
R9	4.0	4.0	9.8
DISCONNECT TORQUE (N-m)			
OS30FACG12	1.9		
OS60U12	3.4		
OS100U03	5.7		
OS200U03	22		
OS400U03	42		

* CLASS 1 CONTROL CIRCUIT or USE CLASS 1 CONDUCTIONS			
RHTR	TEMPERATURE HEATER ON	HEATER OFF	
H/L/O	JUMPER (X1)	TEMPERATURE	21.4°C
DEFAULT	SETTING		70.5°F
(X1)	JUMPER: LO		
ALTERNATE	SETTING		24.4°C
(X1)	JUMPER: H		76.5°F

TERMINAL #	FUNCTION
1	SCR
2	A11
3	A10D
4	+10V
5	A12
6	A10D
7	A01
8	A02
9	A10D
X2 AND X3	AUX VOLTAGE OUTPUT / PROGRAMMABLE DIGITAL INPUTS
10	+24V
11	D10D
12	D01M
13	D11
14	D12
15	D13
16	D14
17	D15
18	D16
X6, X7, AND X8	RELAY OUTPUTS
19	R01C
20	R01A
21	R01B
22	R02C
23	R02A
24	R02B
25	R03C
26	R03A
27	R03B
X9	EMBEDDED FIELDS
29	B+
30	A-
31	D10D
34	TEMA
35	BA5
X10	24V AC / DC
40	24VAC/DC+ IN EXTERNAL 24V AC / DC INPUT TO POWER THE CONTROL
41	24VAC/DC- IN UNIT WHEN THE MAIN SUPPLY IS DISCONNECTED.

NOTE: TERMINALS 40 AND 41 AVAILABLE ON R6 AND LARGER ONLY.

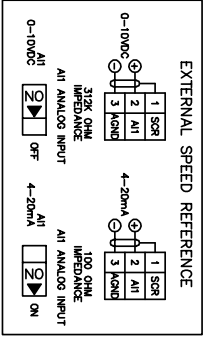
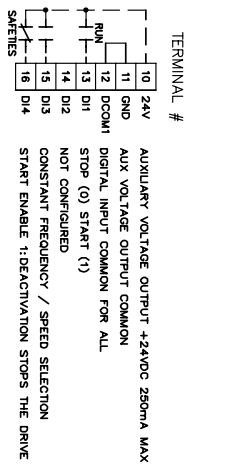

- 22 R02C — RELAY OUTPUT 3 PROGRAMMABLE DEFAULT "FAULT-1"
- 23 R02A — RELAY OUTPUT 2 PROGRAMMABLE DEFAULT "FAULT-1"
- 24 R02B — RELAY OUTPUT 1 PROGRAMMABLE DEFAULT "FAULT-1"
- 27 R03B — RELAY OUTPUT 3 PROGRAMMABLE DEFAULT "FAULT-1"
- 28 R03A — RELAY OUTPUT 2 PROGRAMMABLE DEFAULT "FAULT-1"
- 29 R03C — RELAY OUTPUT 1 PROGRAMMABLE DEFAULT "FAULT-1"

UH — NON-BYPASS DRIVE ONLY
 PF — NON-BYPASS WITH FUSED DISC
 B058 — TYPE 3R
 — REFER TO PANEL LABEL FOR OPTIONS

LEGEND

OPTIONAL PANEL COMPONENTS

WIRING PROVIDED BY ABB

WIRING NOT PROVIDED BY ABB

WIRING CONFIGURATION—FACTORY/FIELD

— TERMINAL POINT

▲ — REMOTE DEVICE (BY OTHERS)

▽ — WIRE CONTINUATION POINT

NOTES:

A CONTACT CLOSURE BETWEEN 10 AND 13 CAUSES THE DRIVE TO START. (10 TO 16 MUST BE CLOSED)

A CONTACT CLOSURE BETWEEN 10 AND 15 WILL CAUSE DRIVE TO RUN AT A PRESET SPEED. SET PARAMETER 28,26 TO DESIRED SPEED.

A CONTACT CLOSURE BETWEEN 10 AND 16 WILL ENABLE THE MOTOR TO RUN

FIGURE 57 - N1-N3R FUSED DISC NON BYPASS

Appendix B

CONTROL CABLES, INPUT, OUTPUT, AND GROUND POWER CABLES WIRE SIZES AND TORQUES NEMA 1/UL TYPE 1

TABLE 32 - AYK580-01 (208/230 V)

HP ¹	JCI 208V PART NUM- BER ³	JCI 230V PART NUM- BER ³	VENDOR 208/230V PART NUMBER ³	DRIVE R FRAME	"MAXIMUM (AMPS)"	"MAX WIRE SIZE CON- TROL (AWG)"	"TORQUE VALUES CONTROL TERMINALS (LB-IN)"
1	024-41675-001	024-41675-006	AYK580-01-04A6-2	R1	4.6	#24...#16	4.8
1.5	024-41675-002	024-41675-007	AYK580-01-06A6-2	R1	6.6	#24...#16	4.8
2	024-41675-003	024-41675-008	AYK580-01-07A5-2	R1	7.5	#24...#16	4.8
3	024-41675-004	024-41675-009	AYK580-01-10A6-2	R1	10.6	#24...#16	4.8
5	024-41675-005	024-41675-010	AYK580-01-017A-2	R1	16.7	#24...#16	4.8
7.5	024-41676-001	024-41676-003	AYK580-01-024A-2	R2	24.2	#24...#16	4.8
10	024-41676-002	024-41676-004	AYK580-01-031A-2	R2	30.8	#24...#16	4.8
15	024-41677-001	024-41677-003	AYK580-01-046A-2	R3	46.2	#24...#16	4.8
20	024-41677-002	024-41677-004	AYK580-01-059A-2	R3	59.4	#24...#16	4.8
25	024-41678-001	024-41678-002	AYK580-01-075A-2	R4	74.8	#24...#16	4.8
30	024-41679-001	024-41679-003	AYK580-01-088A-2	R5	88	#24...#16	4.8
40	024-41679-002	024-41679-004	AYK580-01-114A-2	R5	114	#24...#16	4.8
50	024-41680-001	024-41680-002	AYK580-01-143A-2	R6	143	#24...#16	4.8
60	024-41681-001	024-41681-003	AYK580-01-169A-2	R7	169	#24...#16	4.8
75	024-41681-002	024-41681-004	AYK580-01-211A-2	R7	211	#24...#16	4.8
100	024-41682-001	024-41682-002	AYK580-01-273A-2	R8	273	#24...#16	4.8

1. The VFD Horsepower is for reference ONLY.

2. The VFD does not come as standard with drive input fusing. Drive input fuses are REQUIRED BY OTHERS to meet current UL61800-5-1.

3. ALL VFD BASE DRIVES come standard with Nema 1 Conduit Box

TABLE 32 - AYK580-01 (208/230 V) (CONT'D)

"INPUT & OUTPUT MAX WIRE SIZE POWER SIZE POWER (AWG)"	"TORQUE VALUES POWER TERMI- NALS (LB-IN)"	" GROUND LUG WIRE SIZES (AWG)"	"TORQUE VALUES GND LUG (LB-IN)"	"LITTELFUSE, BUSS- MANN, MERSEN RECOMMENDED FUSE PART NUM- BER2"	"FUSE SIZE (AMPS)"
#14...#10	8	#18 ... #6	1.1	KTK-R-15 or JJS-15	15
#14...#10	8	#18 ... #6	1.1	KTK-R-15 or JJS-15	15
#14...#10	8	#18 ... #6	1.1	KTK-R-15 or JJS-15	15
#14...#10	8	#18 ... #6	1.1	KTK-R-15 or JJS-15	15
#14...#10	8	#18 ... #6	1.1	KTK-R-30 or JJS-30	30
#14...#6	13	#18 ... #6	1.1	JJS-40	40
#14...#6	13	#18 ... #6	1.1	JJS-40	40
#14...#2	31	#24 ... #2	1.1	JJS-80	80
#14...#2	31	#24 ... #2	1.1	JJS-80	80
#14...#1	36	#12 ... #2	2.1	JJS-100	100
#14...#2/0	48	#2	2.1	JJS-150	150
#14...#2/0	48	#2	2.1	JJS-150	150
#4...300 MCM	264	#350 MCM	7.2	JJS-200	200
#3/0...500 MCM	360	#350 MCM	7.2	JJS-250	250
#3/0...500 MCM	360	#350 MCM	7.2	JJS-300	300
(2) #1/0...300 MCM	360	(2) #350 MCM	7.2	JJS-400	400

1. The VFD Horsepower is for reference ONLY.
2. The VFD does not come as standard with drive input fusing. Drive input fuses are REQUIRED BY OTHERS to meet current UL61800-5-1.
3. ALL VFD BASE DRIVES come standard with Nema 1 Conduit Box

TABLE 33 - AYK580-01 (480 V)

HP ¹	JCI 460V PART NUMBER ³	VENDOR 460V PART NUMBER ³	"MAXIMUM (AMPS)"	DRIVE R FRAME	"MAX WIRE SIZE CONTROL (AWG)"	"TORQUE VALUES CONTROL TERMINALS (LB-IN)"
1	024-41675-011	AYK580-01-02A1-4	2.1	R1	#24...#16	4.8
1.5	024-41675-012	AYK580-01-03A0-4	3	R1	#24...#16	4.8
2	024-41675-013	AYK580-01-03A5-4	3.5	R1	#24...#16	4.8
3	024-41675-014	AYK580-01-04A8-4	4.8	R1	#24...#16	4.8
5	024-41675-015	AYK580-01-07A6-4	7.6	R1	#24...#16	4.8
7.5	024-41675-016	AYK580-01-012A-4	12	R1	#24...#16	4.8
10	024-41676-005	AYK580-01-014A-4	14	R2	#24...#16	4.8
15	024-41676-006	AYK580-01-023A-4	23	R2	#24...#16	4.8
20	024-41677-005	AYK580-01-027A-4	27	R3	#24...#16	4.8
25	024-41677-006	AYK580-01-034A-4	34	R3	#24...#16	4.8
30	024-41677-007	AYK580-01-044A-4	44	R3	#24...#16	4.8
40	024-41678-003	AYK580-01-052A-4	52	R4	#24...#16	4.8
50	024-41678-004	AYK580-01-065A-4	62	R4	#24...#16	4.8
60	024-41678-005	AYK580-01-077A-4	77	R4	#24...#16	4.8
75	024-41679-005	AYK580-01-096A-4	96	R5	#24...#16	4.8
100	024-41680-003	AYK580-01-124A-4	124	R6	#24...#16	4.8
125	024-41681-005	AYK580-01-156A-4	156	R7	#24...#16	4.8
150	024-41681-006	AYK580-01-180A-4	180	R7	#24...#16	4.8
200	024-41682-003	AYK580-01-240A-4	240	R8	#24...#16	4.8
250	024-41683-001	AYK580-01-302A-4	302	R9	#24...#16	4.8
300	024-41683-002	AYK580-01-361A-4	361	R9	#24...#16	4.8
350	024-41683-003	AYK580-01-414A-4	414	R9	#24...#16	4.8

1. The VFD Horsepower is for reference ONLY.

2. The VFD does not come as standard with drive input fusing. Drive input fuses are REQUIRED BY OTHERS to meet current UL61800-5-1.

3. ALL VFD BASE DRIVES come standard with Nema 1 Conduit Box

TABLE 33 -AYK580-01 (480 V) (CONT'D)

"INPUT & OUTPUT MAX WIRE SIZE POWER (AWG)"	"TORQUE VALUES POWER TERMINALS (LB-IN)"	" GROUND LUG WIRE SIZES (AWG)"	"TORQUE VALUES GND LUG (LB-IN)"	"LITTELFUSE, BUSSMANN, MERSEN RECOMMENDED FUSE PART NUMBER2"	"FUSE SIZE (AMPS)"
#14...#10	8	#18 ... #6	1.1	KTK-R-15 or JJS-15	15
#14...#10	8	#18 ... #6	1.1	KTK-R-15 or JJS-15	15
#14...#10	8	#18 ... #6	1.1	KTK-R-15 or JJS-15	15
#14...#10	8	#18 ... #6	1.1	KTK-R-15 or JJS-15	15
#14...#10	8	#18 ... #6	1.1	KTK-R-15 or JJS-15	15
#14...#10	8	#18 ... #6	1.1	KTK-R-15 or JJS-15	15
#14...#6	13	#18 ... #6	1.1	KTK-R-30 or JJS-30	30
#14...#6	13	#18 ... #6	1.1	KTK-R-30 or JJS-30	30
#14...#2	31	#24 ... #2	1.1	JJS-40	40
#14...#2	31	#24 ... #2	1.1	JJS-60	60
#14...#2	31	#24 ... #2	1.1	JJS-60	60
#14...#1	36	#12 ... #2	2.1	JJS-80	80
#14...#1	36	#12 ... #2	2.1	JJS-100	100
#14...#1	36	#12 ... #2	2.1	JJS-100	100
#14...#2/0	48	#2	2.1	JJS-150	150
#4...300 MCM	264	#350 MCM	7.2	JJS-200	200
#3/0...500 MCM	360	#350 MCM	7.2	JJS-225	225
#3/0...500 MCM	360	#350 MCM	7.2	JJS-300	300
(2) #1/0...300 MCM	360	(2) #350 MCM	7.2	JJS-350	350
(2) #3/0...500 MCM	624	(2) #350 MCM	7.2	JJS-500	500
(2) #3/0...500 MCM	624	(2) #350 MCM	7.2	JJS-500	500
(2) #3/0...500 MCM	624	(2) #350 MCM	7.2	JJS-600	600

1. The VFD Horsepower is for reference ONLY.
2. The VFD does not come as standard with drive input fusing. Drive input fuses are REQUIRED BY OTHERS to meet current UL61800-5-1.
3. ALL VFD BASE DRIVES come standard with Nema 1 Conduit Box

TABLE 34 - AYK580-01 (575 V)

HP ¹	JCI 575V PART NUMBER ³	VENDOR 575V PART NUMBER ³	"MAXIMUM (AMPS)"	DRIVE R FRAME	"MAX WIRE SIZE CONTROL (AWG)"	"TORQUE VALUES CONTROL TERMINALS (LB-IN)"
2	024-41676-007	AYK580-01-02A7-6	2.7	R2	#24...#16	4.8
3	024-41676-008	AYK580-01-03A9-6	3.9	R2	#24...#16	4.8
5	024-41676-009	AYK580-01-06A1-6	6.1	R2	#24...#16	4.8
7.5	024-41676-010	AYK580-01-09A0-6	9	R2	#24...#16	4.8
10	024-41676-011	AYK580-01-011A-6	11	R2	#24...#16	4.8
15	024-41676-012	AYK580-01-017A-6	17	R2	#24...#16	4.8
20	024-41677-008	AYK580-01-022A-6	22	R3	#24...#16	4.8
25	024-41677-009	AYK580-01-027A-6	27	R3	#24...#16	4.8
30	024-41677-010	AYK580-01-032A-6	32	R3	#24...#16	4.8
40	024-41679-006	AYK580-01-041A-6	41	R5	#24...#16	4.8
50	024-41679-007	AYK580-01-052A-6	52	R5	#24...#16	4.8
60	024-41679-008	AYK580-01-062A-6	62	R5	#24...#16	4.8
75	024-41679-009	AYK580-01-077A-6	77	R5	#24...#16	4.8
100	024-41681-007	AYK580-01-099A-6	99	R7	#24...#16	4.8
125	024-41681-008	AYK580-01-125A-6	125	R7	#24...#16	4.8
150	024-41682-004	AYK580-01-144A-6	144	R8	#24...#16	4.8
200	024-41683-004	AYK580-01-192A-6	192	R9	#24...#16	4.8
250	024-41683-005	AYK580-01-242A-6	242	R9	#24...#16	4.8
250	024-41683-006	AYK580-01-271A-6	271	R9	#24...#16	4.8

1. The VFD Horsepower is for reference ONLY.
2. The VFD does not come as standard with drive input fusing. Drive input fuses are REQUIRED BY OTHERS to meet current UL61800-5-1.
3. ALL VFD BASE DRIVES come standard with Nema 1 Conduit Box

TABLE 34 - AYK580-01 (575 V) (CONT'D)

"INPUT & OUTPUT MAX WIRE SIZE POWER (AWG)"	"TORQUE VALUES POWER TERMI- NALS (LB-IN)"	" GROUND LUG WIRE SIZES (AWG)"	"TORQUE VALUES GND LUG (LB-IN)"	"LITTELFUSE, BUSSMANN, MERSEN RECOMMENDED FUSE PART NUM- BER2"	"FUSE SIZE (AMPS)"
#14...#6	13	#18 ... #6	1.1	KTK-R-15 or JJS-15	15
#14...#6	13	#18 ... #6	1.1	KTK-R-15 or JJS-15	15
#14...#6	13	#18 ... #6	1.1	KTK-R-15 or JJS-15	15
#14...#6	13	#18 ... #6	1.1	KTK-R-15 or JJS-15	15
#14...#6	13	#18 ... #6	1.1	KTK-R-15 or JJS-15	15
#14...#6	13	#18 ... #6	1.1	KTK-R-30 or JJS-30	30
#14...#2	31	#24 ... #2	1.1	JJS-40	40
#14...#2	31	#24 ... #2	1.1	JJS-40	40
#14...#2	31	#24 ... #2	1.1	JJS-40	40
#14...#2/0	48	#2	2.1	JJS-100	100
#14...#2/0	48	#2	2.1	JJS-100	100
#14...#2/0	48	#2	2.1	JJS-100	100
#14...#2/0	48	#2	2.1	JJS-100	100
#3/0...500 MCM	360	#350 MCM	7.2	JJS-150	150
#3/0...500 MCM	360	#350 MCM	7.2	JJS-200	200
(2) #1/0...300 MCM	360	(2) #350 MCM	7.2	JJS-250	250
(2) #3/0...500 MCM	624	(2) #350 MCM	7.2	JJS-300	300
(2) #3/0...500 MCM	624	(2) #350 MCM	7.2	JJS-400	400
(2) #3/0...500 MCM	624	(2) #350 MCM	7.2	JJS-400	400

1. The VFD Horsepower is for reference ONLY.
2. The VFD does not come as standard with drive input fusing. Drive input fuses are REQUIRED BY OTHERS to meet current UL61800-5-1.
3. ALL VFD BASE DRIVES come standard with Nema 1 Conduit Box

TABLE 35 - AYK580-PF (208/230 V)

HP ¹	JCI 208V PART NUMBER	JCI 230V PART NUMBER	VENDOR 208/230V PART NUMBER	"MAXIMUM (AMPS)"	"MAX WIRE SIZE CONTROL (AWG)"	"TORQUE VAL- UES CONTROL TER- MINALS (LB-IN)"
1	024-41684-001	024-41684-006	AYK580-PF-04A6-2	4.6	#24...#16	4.8
1.5	024-41684-002	024-41684-007	AYK580-PF-06A6-2	6.6	#24...#16	4.8
2	024-41684-003	024-41684-008	AYK580-PF-07A5-2	7.5	#24...#16	4.8
3	024-41684-004	024-41684-009	AYK580-PF-10A6-2	10.6	#24...#16	4.8
5	024-41684-005	024-41684-010	AYK580-PF-017A-2	16.7	#24...#16	4.8
7.5	024-41685-001	024-41685-003	AYK580-PF-024A-2	24.2	#24...#16	4.8
10	024-41685-002	024-41685-004	AYK580-PF-031A-2	30.8	#24...#16	4.8
15	024-41686-001	024-41686-003	AYK580-PF-046A-2	46.2	#24...#16	4.8
20	024-41686-002	024-41686-004	AYK580-PF-059A-2	59.4	#24...#16	4.8
25	024-41688-001	024-41688-002	AYK580-PF-075A-2	74.8	#24...#16	4.8
30	024-41689-001	024-41689-003	AYK580-PF-088A-2	88	#24...#16	4.8
40	024-41689-002	024-41689-004	AYK580-PF-114A-2	114	#24...#16	4.8
50	024-41691-001	024-41691-002	AYK580-PF-143A-2	143	#24...#16	4.8
60	024-41693-001	024-41693-003	AYK580-PF-169A-2	169	#24...#16	4.8
75	024-41693-002	024-41693-004	AYK580-PF-211A-2	211	#24...#16	4.8

1. The VFD Horsepower is for reference ONLY.

TABLE 35 - AYK580-PF (208/230 V) (CONT'D)

"INPUT MAX WIRE SIZE POWER (AWG)"	"TORQUE VALUES POWER TERMINALS (LB-IN)"	"OUTPUT MAX WIRE SIZE POWER (AWG)"	"TORQUE VALUES POWER TERMINALS (LB-IN)"	GRND WIRE RANGE	"TERMINAL TORQUE (IN-LB)"
#18...#8	17	#14...#10	8	#14 ... #2	50
#18...#8	17	#14...#10	8	#14 ... #2	50
#18...#8	17	#14...#10	8	#14 ... #2	50
#18...#8	17	#14...#10	8	#14 ... #2	50
#18...#8	17	#14...#10	8	#14 ... #2	50
#18...#8	17	#14...#6	13	#14 ... #2	50
#14...#4	30...35	#14...#6	13	#14 ... #2	50
#14...2/0	120	#14...#2	31	#14 ... #2	50
#14...2/0	120	#14...#2	31	#14 ... #2	50
#14...2/0	120	#14...#1	36	#14 ... #2	50
#4...300 MCM	275	#14...#2/0	48	#14 ... #2	50
#4...300 MCM	275	#14...#2/0	48	#14 ... #2	50
#4...300 MCM	275	#4...300 MCM	264	#14 ... #2	50
#2...600 MCM	375	#3/0...500 MCM	360	#14 ... #2	50
#2...600 MCM	375	#3/0...500 MCM	360	#14 ... #2	50

1. The VFD Horsepower is for reference ONLY.

TABLE 36 - AYK580-PF (460 V)

HP ¹	JCI 460V PART NUMBER	VENDOR 460V PART NUMBER	"MAXIMUM (AMPS)"	"MAX WIRE SIZE CONTROL (AWG)"	"TORQUE VALUES CONTROL TERMI- NALS (LB-IN)"
1	024-41684-011	AYK580-PF-02A1-4	2.1	#24...#16	4.8
1.5	024-41684-012	AYK580-PF-03A0-4	3	#24...#16	4.8
2	024-41684-013	AYK580-PF-03A5-4	3.5	#24...#16	4.8
3	024-41684-014	AYK580-PF-04A8-4	4.8	#24...#16	4.8
5	024-41684-015	AYK580-PF-07A6-4	7.6	#24...#16	4.8
7.5	024-41684-016	AYK580-PF-012A-4	12	#24...#16	4.8
10	024-41685-005	AYK580-PF-014A-4	14	#24...#16	4.8
15	024-41685-006	AYK580-PF-023A-4	23	#24...#16	4.8
20	024-41686-005	AYK580-PF-027A-4	27	#24...#16	4.8
25	024-41686-006	AYK580-PF-034A-4	34	#24...#16	4.8
30	024-41686-007	AYK580-PF-044A-4	44	#24...#16	4.8
40	024-41688-003	AYK580-PF-052A-4	52	#24...#16	4.8
50	024-41688-004	AYK580-PF-065A-4	65	#24...#16	4.8
60	024-41688-005	AYK580-PF-077A-4	77	#24...#16	4.8
75	024-41689-005	AYK580-PF-096A-4	96	#24...#16	4.8
100	024-41692-001	AYK580-PF-124A-4	124	#24...#16	4.8
125	024-41693-005	AYK580-PF-156A-4	156	#24...#16	4.8
150	024-41693-006	AYK580-PF-180A-4	180	#24...#16	4.8

1. The VFD Horsepower is for reference ONLY.

TABLE 36 - AYK580-PF (460 V) (CONT'D)

"INPUT MAX WIRE SIZE POWER (AWG)"	"TORQUE VALUES POWER TERMINALS (LB-IN)"	"OUTPUT MAX WIRE SIZE POWER (AWG)"	"TORQUE VALUES POWER TERMINALS (LB-IN)"	GRND WIRE RANGE	"TERMINAL TORQUE (IN-LB)"
#18...#8	17	#14...#10	8	#14 ... #2	50
#18...#8	17	#14...#10	8	#14 ... #2	50
#18...#8	17	#14...#10	8	#14 ... #2	50
#18...#8	17	#14...#10	8	#14 ... #2	50
#18...#8	17	#14...#10	8	#14 ... #2	50
#18...#8	17	#14...#10	8	#14 ... #2	50
#18...#8	17	#14...#6	13	#14 ... #2	50
#18...#8	17	#14...#6	13	#14 ... #2	50
#14...#4	30...35	#14...#2	31	#14 ... #2	50
#14...#4	30...35	#14...#2	31	#14 ... #2	50
#14...#4	30...35	#14...#2	31	#14 ... #2	50
#14...2/0	120	#14...#1	36	#14 ... #2	50
#14...2/0	120	#14...#1	36	#14 ... #2	50
#14...2/0	120	#14...#1	36	#14 ... #2	50
#4...300 MCM	275	#14...#2/0	48	#14 ... #2	50
#4...300 MCM	275	#4...300 MCM	264	#14 ... #2	50
#2...600 MCM	375	#3/0...500 MCM	360	#14 ... #2	50
#2...600 MCM	375	#3/0...500 MCM	360	#14 ... #2	50

1. The VFD Horsepower is for reference ONLY.

TABLE 37 - AYK580-PF (575 V)

HP ¹	JCI 575V PART NUMBER	VENDOR 575V PART NUMBER	"MAXIMUM (AMPS)"	"MAX WIRE SIZE CONTROL (AWG)"	"TORQUE VALUES CONTROL TERMI- NALS (LB-IN)"
2	024-41685-007	AYK580-PF-02A7-6	2.7	#24...#16	4.8
3	024-41685-008	AYK580-PF-03A9-6	3.9	#24...#16	4.8
5	024-41685-009	AYK580-PF-06A1-6	6.1	#24...#16	4.8
7.5	024-41685-010	AYK580-PF-09A0-6	9	#24...#16	4.8
10	024-41685-011	AYK580-PF-011A-6	11	#24...#16	4.8
15	024-41685-012	AYK580-PF-017A-6	17	#24...#16	4.8
20	024-41686-008	AYK580-PF-022A-6	22	#24...#16	4.8
25	024-41686-009	AYK580-PF-027A-6	27	#24...#16	4.8
30	024-41687-001	AYK580-PF-032A-6	32	#24...#16	4.8
40	024-41689-006	AYK580-PF-041A-6	41	#24...#16	4.8
50	024-41689-007	AYK580-PF-052A-6	52	#24...#16	4.8
60	024-41689-008	AYK580-PF-062A-6	62	#24...#16	4.8
75	024-41690-001	AYK580-PF-077A-6	77	#24...#16	4.8
100	024-41693-007	AYK580-PF-099A-6	99	#24...#16	4.8
125	024-41693-008	AYK580-PF-125A-6	125	#24...#16	4.8

1. The VFD Horsepower is for reference ONLY.

TABLE 37 - AYK580-PF (575 V) (CONT'D)

"INPUT MAX WIRE SIZE POWER (AWG)"	"TORQUE VALUES POWER TERMINALS (LB-IN)"	"OUTPUT MAX WIRE SIZE POWER (AWG)"	"TORQUE VALUES POWER TERMINALS (LB-IN)"	GRND WIRE RANGE	"TERMINAL TORQUE (IN-LB)"
#18...#8	17	#14...#6	13	#14 ... #2	50
#18...#8	17	#14...#6	13	#14 ... #2	50
#18...#8	17	#14...#6	13	#14 ... #2	50
#18...#8	17	#14...#6	13	#14 ... #2	50
#18...#8	17	#14...#6	13	#14 ... #2	50
#18...#8	17	#14...#6	13	#14 ... #2	50
#14...#4	30...35	#14...#2	31	#14 ... #2	50
#14...#4	30...35	#14...#2	31	#14 ... #2	50
#14...#4	30...35	#14...#2	31	#14 ... #2	50
#14...#4	30...35	#14...#2/0	48	#14 ... #2	50
#14...2/0	120	#14...#2/0	48	#14 ... #2	50
#14...2/0	120	#14...#2/0	48	#14 ... #2	50
#14...2/0	120	#14...#2/0	48	#14 ... #2	50
#4...300 MCM	275	#3/0...500 MCM	360	#14 ... #2	50
#4...300 MCM	275	#3/0...500 MCM	360	#14 ... #2	50

1. The VFD Horsepower is for reference ONLY.

TABLE 38 - AYK580-CF (08/230 V)

HP ¹	JCI 208V PART NUMBER	JCI 230V PART NUMBER	VENDOR 208/230V PART NUMBER	"MAXIMUM (AMPS)"	"MAX WIRE SIZE CONTROL (AWG)"	"TORQUE VAL- UES CONTROL TER- MINALS (LB-IN)"
1	024-41713-001	024-41713-006	AYK580-PF-04A6-2+B058	4.6	#24...#16	4.8
1.5	024-41713-002	024-41713-007	AYK580-PF-06A6-2+B058	6.6	#24...#16	4.8
2	024-41713-003	024-41713-008	AYK580-PF-07A5-2+B058	7.5	#24...#16	4.8
3	024-41713-004	024-41713-009	AYK580-PF-10A6-2+B058	10.6	#24...#16	4.8
5	024-41713-005	024-41713-010	AYK580-PF-017A-2+B058	16.7	#24...#16	4.8
7.5	024-41714-001	024-41714-003	AYK580-PF-024A-2+B058	24.2	#24...#16	4.8
10	024-41714-002	024-41714-004	AYK580-PF-031A-2+B058	30.8	#24...#16	4.8
15	024-41715-001	024-41715-003	AYK580-PF-046A-2+B058	46.2	#24...#16	4.8
20	024-41715-002	024-41715-004	AYK580-PF-059A-2+B058	59.4	#24...#16	4.8
25	024-41717-001	024-41717-002	AYK580-PF-075A-2+B058	74.8	#24...#16	4.8
30	024-41718-001	024-41718-003	AYK580-PF-088A-2+B058	88	#24...#16	4.8
40	024-41718-002	024-41718-004	AYK580-PF-114A-2+B058	114	#24...#16	4.8
50	024-41720-001	024-41720-002	AYK580-PF-143A-2+B058	143	#24...#16	4.8
60	024-41722-001	024-41722-003	AYK580-PF-169A-2+B058	169	#24...#16	4.8
75	024-41722-002	024-41722-004	AYK580-PF-211A-2+B058	211	#24...#16	4.8

1. The VFD Horsepower is for reference ONLY.

TABLE 38 - AYK580-CF (08/230 V) (CONT'D)

"INPUT MAX WIRE SIZE POWER (AWG)"	"TORQUE VALUES POWER TERMINALS (LB-IN)"	"OUTPUT MAX WIRE SIZE POWER (AWG)"	"TORQUE VALUES POWER TERMINALS (LB-IN)"	GRND WIRE RANGE	"TERMINAL TORQUE (IN-LB)"
#18...#8	17	#14...#10	8	#14 ... #2	50
#18...#8	17	#14...#10	8	#14 ... #2	50
#18...#8	17	#14...#10	8	#14 ... #2	50
#18...#8	17	#14...#10	8	#14 ... #2	50
#18...#8	17	#14...#10	8	#14 ... #2	50
#18...#8	17	#14...#6	13	#14 ... #2	50
#14...#4	30...35	#14...#6	13	#14 ... #2	50
#14...2/0	120	#14...#2	31	#14 ... #2	50
#14...2/0	120	#14...#2	31	#14 ... #2	50
#14...2/0	120	#14...#1	36	#14 ... #2	50
#4...300 MCM	275	#14...#2/0	48	#14 ... #2	50
#4...300 MCM	275	#14...#2/0	48	#14 ... #2	50
#4...300 MCM	275	#4...300 MCM	264	#14 ... #2	50
#2...600 MCM	375	#3/0...500 MCM	360	#14 ... #2	50
#2...600 MCM	375	#3/0...500 MCM	360	#14 ... #2	50

1. The VFD Horsepower is for reference ONLY.

TABLE 39 - AYK580-CF (460 V)

HP1	JCI 460V PART NUMBER	VENDOR 460V PART NUMBER	"MAXIMUM (AMPS)"	"MAX WIRE SIZE CONTROL (AWG)"	"TORQUE VALUES CONTROL TERMI- NALS (LB-IN)"
1	024-41713-011	AYK580-PF-02A1-4+B058	2.1	#24...#16	4.8
1.5	024-41713-012	AYK580-PF-03A0-4+B058	3	#24...#16	4.8
2	024-41713-013	AYK580-PF-03A5-4+B058	3.5	#24...#16	4.8
3	024-41713-014	AYK580-PF-04A8-4+B058	4.8	#24...#16	4.8
5	024-41713-015	AYK580-PF-07A6-4+B058	7.6	#24...#16	4.8
7.5	024-41713-016	AYK580-PF-012A-4+B058	12	#24...#16	4.8
10	024-41714-005	AYK580-PF-014A-4+B058	14	#24...#16	4.8
15	024-41714-006	AYK580-PF-023A-4+B058	23	#24...#16	4.8
20	024-41715-005	AYK580-PF-027A-4+B058	27	#24...#16	4.8
25	024-41715-006	AYK580-PF-034A-4+B058	34	#24...#16	4.8
30	024-41715-007	AYK580-PF-044A-4+B058	44	#24...#16	4.8
40	024-41717-003	AYK580-PF-052A-4+B058	52	#24...#16	4.8
50	024-41717-004	AYK580-PF-065A-4+B058	65	#24...#16	4.8
60	024-41717-005	AYK580-PF-077A-4+B058	77	#24...#16	4.8
75	024-41718-005	AYK580-PF-096A-4+B058	96	#24...#16	4.8
100	024-41721-001	AYK580-PF-124A-4+B058	124	#24...#16	4.8
125	024-41722-005	AYK580-PF-156A-4+B058	156	#24...#16	4.8
150	024-41722-006	AYK580-PF-180A-4+B058	180	#24...#16	4.8

1. The VFD Horsepower is for reference ONLY.

TABLE 39 - AYK580-CF (460 V) (CONT'D)

"INPUT MAX WIRE SIZE POWER (AWG)"	"TORQUE VALUES POWER TERMINALS (LB-IN)"	"OUTPUT MAX WIRE SIZE POWER (AWG)"	"TORQUE VALUES POWER TERMINALS (LB-IN)"	GRND WIRE RANGE	"TERMINAL TORQUE (IN-LB)"
#18...#8	17	#14...#10	8	#14 ... #2	50
#18...#8	17	#14...#10	8	#14 ... #2	50
#18...#8	17	#14...#10	8	#14 ... #2	50
#18...#8	17	#14...#10	8	#14 ... #2	50
#18...#8	17	#14...#10	8	#14 ... #2	50
#18...#8	17	#14...#10	8	#14 ... #2	50
#18...#8	17	#14...#6	13	#14 ... #2	50
#18...#8	17	#14...#6	13	#14 ... #2	50
#14...#4	30...35	#14...#2	31	#14 ... #2	50
#14...#4	30...35	#14...#2	31	#14 ... #2	50
#14...#4	30...35	#14...#2	31	#14 ... #2	50
#14...2/0	120	#14...#1	36	#14 ... #2	50
#14...2/0	120	#14...#1	36	#14 ... #2	50
#14...2/0	120	#14...#1	36	#14 ... #2	50
#4...300 MCM	275	#14...#2/0	48	#14 ... #2	50
#4...300 MCM	275	#4...300 MCM	264	#14 ... #2	50
#2...600 MCM	375	#3/0...500 MCM	360	#14 ... #2	50
#2...600 MCM	375	#3/0...500 MCM	360	#14 ... #2	50

1. The VFD Horsepower is for reference ONLY.

TABLE 40 - AYK580-CF (460 V)

HP ¹	JCI 575V PART NUMBER	VENDOR 575V PART NUMBER	"MAXIMUM (AMPS)"	"MAX WIRE SIZE CONTROL (AWG)"	"TORQUE VALUES CONTROL TERMI- NALS (LB-IN)"
2	024-41714-007	AYK580-PF-02A7-6+B058	2.7	#24...#16	4.8
3	024-41714-008	AYK580-PF-03A9-6+B058	3.9	#24...#16	4.8
5	024-41714-009	AYK580-PF-06A1-6+B058	6.1	#24...#16	4.8
7.5	024-41714-010	AYK580-PF-09A0-6+B058	9	#24...#16	4.8
10	024-41714-011	AYK580-PF-011A-6+B058	11	#24...#16	4.8
15	024-41714-012	AYK580-PF-017A-6+B058	17	#24...#16	4.8
20	024-41715-008	AYK580-PF-022A-6+B058	22	#24...#16	4.8
25	024-41715-009	AYK580-PF-027A-6+B058	27	#24...#16	4.8
30	024-41716-001	AYK580-PF-032A-6+B058	32	#24...#16	4.8
40	024-41718-006	AYK580-PF-041A-6+B058	41	#24...#16	4.8
50	024-41718-007	AYK580-PF-052A-6+B058	52	#24...#16	4.8
60	024-41718-008	AYK580-PF-062A-6+B058	62	#24...#16	4.8
75	024-41719-001	AYK580-PF-077A-6+B058	77	#24...#16	4.8
100	024-41722-007	AYK580-PF-099A-6+B058	99	#24...#16	4.8
125	024-41722-008	AYK580-PF-125A-6+B058	125	#24...#16	4.8

1. The VFD Horsepower is for reference ONLY.

TABLE 40 - AYK580-CF (460 V) (CONT'D)

"INPUT MAX WIRE SIZE POWER (AWG)"	"TORQUE VALUES POWER TERMINALS (LB-IN)"	"OUTPUT MAX WIRE SIZE POWER (AWG)"	"TORQUE VALUES POWER TERMINALS (LB-IN)"	GRND WIRE RANGE	"TERMINAL TORQUE (IN-LB)"
#18...#8	17	#14...#6	13	#14 ... #2	50
#18...#8	17	#14...#6	13	#14 ... #2	50
#18...#8	17	#14...#6	13	#14 ... #2	50
#18...#8	17	#14...#6	13	#14 ... #2	50
#18...#8	17	#14...#6	13	#14 ... #2	50
#18...#8	17	#14...#6	13	#14 ... #2	50
#14...#4	30...35	#14...#2	31	#14 ... #2	50
#14...#4	30...35	#14...#2	31	#14 ... #2	50
#14...#4	30...35	#14...#2	31	#14 ... #2	50
#14...#4	30...35	#14...#2/0	48	#14 ... #2	50
#14...2/0	120	#14...#2/0	48	#14 ... #2	50
#14...2/0	120	#14...#2/0	48	#14 ... #2	50
#14...2/0	120	#14...#2/0	48	#14 ... #2	50
#4...300 MCM	275	#3/0...500 MCM	360	#14 ... #2	50
#4...300 MCM	275	#3/0...500 MCM	360	#14 ... #2	50

1. The VFD Horsepower is for reference ONLY.

CONTROL CABLES, INPUT, OUTPUT, AND GROUND POWER CABLES WIRE SIZES AND TORQUES NEMA 3/UL TYPE 3R

TABLE 41 - AYK580-PF+B058 (208/230 V)

HP ¹	JCI 208V PART NUMBER	JCI 230V PART NUMBER	ABB 208/230V PART NUMBER	"ACTUAL MINIMUM (AMPS)"	"MAXIMUM (AMPS)"	"MAX WIRE SIZE CONTROL (AWG)"
1	024-41694-001	024-41694-006	AYK580-CF-04A6-2	1.9	4.6	#24...#16
1.5	024-41694-002	024-41694-007	AYK580-CF-06A6-2	5.7	6.6	#24...#16
2	024-41694-003	024-41694-008	AYK580-CF-07A5-2	5.7	7.5	#24...#16
3	024-41694-004	024-41694-009	AYK580-CF-10A6-2	5.7	10.6	#24...#16
5	024-41694-005	024-41694-010	AYK580-CF-017A-2	5.7	16.7	#24...#16
7.5	024-41695-001	024-41695-003	AYK580-CF-024A-2	9	24.2	#24...#16
10	024-41695-002	024-41695-004	AYK580-CF-031A-2	15	30.8	#24...#16
15	024-41696-001	024-41696-003	AYK580-CF-046A-2	32	46.2	#24...#16
20	024-41696-002	024-41696-004	AYK580-CF-059A-2	32	59.4	#24...#16
25	024-41698-001	024-41698-002	AYK580-CF-075A-2	32	74.8	#24...#16
30	024-41699-001	024-41699-003	AYK580-CF-088A-2	32	88	#24...#16
40	024-41699-002	024-41699-004	AYK580-CF-114A-2	76	114	#24...#16
50	024-41701-001	024-41701-002	AYK580-CF-143A-2	76	143	#24...#16
60	024-41703-001	024-41703-003	AYK580-CF-169A-2	76	169	#24...#16
75	024-41703-002	024-41703-004	AYK580-CF-211A-2	76	211	#24...#16

1. The VFD Horsepower is for reference ONLY.

TABLE 41 - AYK580-PF+B058 (208/230 V) (CONT'D)

"TORQUE VAL- UES CONTROL TER- MINALS (LB-IN)"	INPUT DISCON- NECT WIRE RANGE	"TERMINAL TORQUE (IN-LB)"	OUTPUT MOTOR WIRE RANGE	"TERMINAL TORQUE (IN-LB)"	INPUT & OUPUT GND WIRE RANGE	"TERMINAL TORQUE (IN-LB)"
4.8	#18...#8	17	#14...#8, #6...#4, #2	35, 45, 50	#14 ... #2	50
4.8	#18...#8	17	#14...#8, #6...#4, #2	35, 45, 50	#14 ... #2	50
4.8	#18...#8	17	#14...#8, #6...#4, #2	35, 45, 50	#14 ... #2	50
4.8	#18...#8	17	#14...#8, #6...#4, #2	35, 45, 50	#14 ... #2	50
4.8	#18...#8	17	#14...#8, #6...#4, #2	35, 45, 50	#14 ... #2	50
4.8	#18...#8	17	#14...#8, #6...#4, #2	35, 45, 50	#14 ... #2	50
4.8	#18...#8	17	#14...#8, #6...#4, #2	35, 45, 50	#14 ... #2	50
4.8	#14...#4	30...35	#14...#8, #6...#4, #2	35, 45, 50	#14 ... #2	50
4.8	#14...2/0	120	#14...#8, #6...#4, #2	35, 45, 50	#14 ... #2	50
4.8	#14...2/0	120	#14...#8, #6...#4, #2	35, 45, 50	#14 ... #2	50
4.8	#14...2/0	120	#14...#10, #8, #6...#4, #2	35, 40, 45, 50	#14 ... #2	50
4.8	#4...300 MCM	275	#14...#10, #8, #6...#4, #2	35, 40, 45, 50	#14 ... #2	50
4.8	#4...300 MCM	275	#14...#10, #8, #6...#4, #2	35, 40, 45, 50	#14 ... #2	50
4.8	#4...300 MCM	275	#6...300 MCM	25	#14 ... #2	50
4.8	#2...600 MCM	375	#6...300 MCM	25	#14 ... #2	50
4.8	#2...600 MCM	375	#4...400 MCM	31	#14 ... #2	50

1. The VFD Horsepower is for reference ONLY.

TABLE 42 - AYK580-PF+B058 (460 V)

HP ¹	JCI 460V PART NUMBER	ABB 460V PART NUMBER	"ACTUAL MINIMUM (AMPS)"	"MAXIMUM (AMPS)"	"MAX WIRE SIZE CONTROL (AWG)"	"TORQUE VAL- UES CONTROL TER- MINALS (LB-IN)"
1	024-41694-011	AYK580-CF-02A1-4	0.8	2.1	#24...#16	4.8
1.5	024-41694-012	AYK580-CF-03A0-4	1.9	3	#24...#16	4.8
2	024-41694-013	AYK580-CF-03A5-4	1.9	3.5	#24...#16	4.8
3	024-41694-014	AYK580-CF-04A8-4	1.9	4.8	#24...#16	4.8
5	024-41694-015	AYK580-CF-07A6-4	5.7	7.6	#24...#16	4.8
7.5	024-41694-016	AYK580-CF-012A-4	5.7	12	#24...#16	4.8
10	024-41695-005	AYK580-CF-014A-4	5.7	14	#24...#16	4.8
15	024-41695-006	AYK580-CF-023A-4	9	23	#24...#16	4.8
20	024-41696-005	AYK580-CF-027A-4	9	27	#24...#16	4.8
25	024-41696-006	AYK580-CF-034A-4	15	34	#24...#16	4.8
30	024-41696-007	AYK580-CF-044A-4	15	44	#24...#16	4.8
40	024-41698-003	AYK580-CF-052A-4	32	52	#24...#16	4.8
50	024-41698-004	AYK580-CF-065A-4	32	65	#24...#16	4.8
60	024-41698-005	AYK580-CF-077A-4	32	77	#24...#16	4.8
75	024-41699-005	AYK580-CF-096A-4	32	96	#24...#16	4.8
100	024-41702-001	AYK580-CF-124A-4	76	124	#24...#16	4.8
125	024-41703-005	AYK580-CF-156A-4	26	156	#24...#16	4.8
150	024-41703-006	AYK580-CF-180A-4	30	180	#24...#16	4.8

1. The VFD Horsepower is for reference ONLY.

TABLE 42 - AYK580-PF+B058 (460 V) (CONT'D)

INPUT DISCONNECT WIRE RANGE	"TERMINAL TORQUE (IN-LB)"	OUTPUT MOTOR WIRE RANGE	"TERMINAL TORQUE (IN-LB)"	INPUT & OUPUT GND WIRE RANGE	"TERMINAL TORQUE (IN-LB)"
#18...#8	17	#14...#8, #6...#4, #2	35, 45, 50	#14 ... #2	50
#18...#8	17	#14...#8, #6...#4, #2	35, 45, 50	#14 ... #2	50
#18...#8	17	#14...#8, #6...#4, #2	35, 45, 50	#14 ... #2	50
#18...#8	17	#14...#8, #6...#4, #2	35, 45, 50	#14 ... #2	50
#18...#8	17	#14...#8, #6...#4, #2	35, 45, 50	#14 ... #2	50
#18...#8	17	#14...#8, #6...#4, #2	35, 45, 50	#14 ... #2	50
#18...#8	17	#14...#8, #6...#4, #2	35, 45, 50	#14 ... #2	50
#18...#8	17	#14...#8, #6...#4, #2	35, 45, 50	#14 ... #2	50
#14...#4	30...35	#14...#8, #6...#4, #2	35, 45, 50	#14 ... #2	50
#14...#4	30...35	#14...#8, #6...#4, #2	35, 45, 50	#14 ... #2	50
#14...#4	30...35	#14...#8, #6...#4, #2	35, 45, 50	#14 ... #2	50
#14...2/0	120	#14...#10, #8, #6...#4, #2	35, 40, 45, 50	#14 ... #2	50
#14...2/0	120	#14...#10, #8, #6...#4, #2	35, 40, 45, 50	#14 ... #2	50
#4...300 MCM	275	#14...#10, #8, #6...#4, #2	35, 40, 45, 50	#14 ... #2	50
#4...300 MCM	275	#14...#10, #8, #6...#4, #2	35, 40, 45, 50	#14 ... #2	50
#4...300 MCM	275	#14...#10, #8, #6...#4, #2	35, 40, 45, 50	#14 ... #2	50
#2...600 MCM	375	#6...300 MCM	25	#14 ... #2	50
#2...600 MCM	375	#6...300 MCM	25	#14 ... #2	50

1. The VFD Horsepower is for reference ONLY.

TABLE 43 - AYK580-PF+B058 (575 V)

HP ¹	JCI PART NUMBER	ABB PART NUMBER	"ACTUAL MINIMUM (AMPS)"	"MAXIMUM (AMPS)"	"MAX WIRE SIZE CONTROL (AWG)"	"TORQUE VALUES CONTROL TERMINALS (LB-IN)"
2	024-41695-007	AYK580-CF-02A7-6	0.5	2.7	#24...#16	4.8
3	024-41695-008	AYK580-CF-03A9-6	1.9	3.9	#24...#16	4.8
5	024-41695-009	AYK580-CF-06A1-6	1.9	6.1	#24...#16	4.8
7.5	024-41695-010	AYK580-CF-09A0-6	5.7	9	#24...#16	4.8
10	024-41695-011	AYK580-CF-011A-6	5.7	11	#24...#16	4.8
15	024-41695-012	AYK580-CF-017A-6	5.7	17	#24...#16	4.8
20	024-41696-008	AYK580-CF-022A-6	9	22	#24...#16	4.8
25	024-41696-009	AYK580-CF-027A-6	9	27	#24...#16	4.8
30	024-41697-001	AYK580-CF-032A-6	15	32	#24...#16	4.8
40	024-41699-006	AYK580-CF-041A-6	15	41	#24...#16	4.8
50	024-41699-007	AYK580-CF-052A-6	32	52	#24...#16	4.8
60	024-41699-008	AYK580-CF-062A-6	32	62	#24...#16	4.8
75	024-41700-001	AYK580-CF-077A-6	32	77	#24...#16	4.8
100	024-41703-007	AYK580-CF-099A-6	32	99	#24...#16	4.8
125	024-41703-008	AYK580-CF-125A-6	76	125	#24...#16	4.8

1. The VFD Horsepower is for reference ONLY.

TABLE 43 - AYK580-PF+B058 (575 V) (CONT'D)

INPUT DISCONNECT WIRE RANGE	"TERMINAL TORQUE (IN-LB)"	OUTPUT MOTOR WIRE RANGE	"TERMINAL TORQUE (IN-LB)"	INPUT & OUPUT GND WIRE RANGE	"TERMINAL TORQUE (IN-LB)"
#18...#8	17	#14...#8, #6...#4, #2	35, 45, 50	#14 ... #2	50
#18...#8	17	#14...#8, #6...#4, #2	35, 45, 50	#14 ... #2	50
#18...#8	17	#14...#8, #6...#4, #2	35, 45, 50	#14 ... #2	50
#18...#8	17	#14...#8, #6...#4, #2	35, 45, 50	#14 ... #2	50
#18...#8	17	#14...#8, #6...#4, #2	35, 45, 50	#14 ... #2	50
#18...#8	17	#14...#8, #6...#4, #2	35, 45, 50	#14 ... #2	50
#14...#4	30...35	#14...#8, #6...#4, #2	35, 45, 50	#14 ... #2	50
#14...#4	30...35	#14...#8, #6...#4, #2	35, 45, 50	#14 ... #2	50
#14...#4	30...35	#14...#10, #8, #6...#4, #2	35, 40, 45, 50	#14 ... #2	50
#14...#4	30...35	#14...#10, #8, #6...#4, #2	35, 40, 45, 50	#14 ... #2	50
#14...2/0	120	#14...#10, #8, #6...#4, #2	35, 40, 45, 50	#14 ... #2	50
#14...2/0	120	#14...#10, #8, #6...#4, #2	35, 40, 45, 50	#14 ... #2	50
#4...300 MCM	275	#14...#10, #8, #6...#4, #2	35, 40, 45, 50	#14 ... #2	50
#4...300 MCM	275	#14...#10, #8, #6...#4, #2	35, 40, 45, 50	#14 ... #2	50
#4...300 MCM	275	#14...#10, #8, #6...#4, #2	35, 40, 45, 50	#14 ... #2	50

1. The VFD Horsepower is for reference ONLY.

TABLE 44 - AYK580-CF+B058 (208/230 V)

HP ¹	JCI 208V PART NUMBER	JCI 230V PART NUMBER	ABB 208/230 PART NUMBER	"ACTUAL MINIMUM (AMPS)"	"MAXIMUM (AMPS)"	"MAX WIRE SIZE CONTROL (AWG)"
1	024-41723-001	024-41723-006	AYK580-CF-04A6-2+B058	1.9	4.6	#24...#16
1.5	024-41723-002	024-41723-007	AYK580-CF-06A6-2+B058	5.7	6.6	#24...#16
2	024-41723-003	024-41723-008	AYK580-CF-07A5-2+B058	5.7	7.5	#24...#16
3	024-41723-004	024-41723-009	AYK580-CF-10A6-2+B058	5.7	10.6	#24...#16
5	024-41723-005	024-41723-010	AYK580-CF-017A-2+B058	5.7	16.7	#24...#16
7.5	024-41724-001	024-41724-003	AYK580-CF-024A-2+B058	9	24.2	#24...#16
10	024-41724-002	024-41724-004	AYK580-CF-031A-2+B058	15	30.8	#24...#16
15	024-41725-001	024-41725-003	AYK580-CF-046A-2+B058	32	46.2	#24...#16
20	024-41725-002	024-41725-004	AYK580-CF-059A-2+B058	32	59.4	#24...#16
25	024-41727-001	024-41727-002	AYK580-CF-075A-2+B058	32	74.8	#24...#16
30	024-41728-001	024-41728-003	AYK580-CF-088A-2+B058	32	88	#24...#16
40	024-41728-002	024-41728-004	AYK580-CF-114A-2+B058	76	114	#24...#16
50	024-41730-001	024-41730-002	AYK580-CF-143A-2+B058	76	143	#24...#16
60	024-41732-001	024-41732-003	AYK580-CF-169A-2+B058	76	169	#24...#16
75	024-41732-002	024-41732-004	AYK580-CF-211A-2+B058	76	211	#24...#16

1. The VFD Horsepower is for reference ONLY.

TABLE 44 - AYK580-CF+B058 (208/230 V) (CONT'D)

"TORQUE VALUES CONTROL TERMINALS (LB-IN)"	INPUT DISCONNECT WIRE RANGE	"TERMINAL TORQUE (IN-LB)"	OUTPUT MOTOR WIRE RANGE	"TERMINAL TORQUE (IN-LB)"	INPUT & OUPUT GND WIRE RANGE	"TERMINAL TORQUE (IN-LB)"
4.8	#18...#8	17	#14...#8, #6...#4, #2	35, 45, 50	#14 ... #2	50
4.8	#18...#8	17	#14...#8, #6...#4, #2	35, 45, 50	#14 ... #2	50
4.8	#18...#8	17	#14...#8, #6...#4, #2	35, 45, 50	#14 ... #2	50
4.8	#18...#8	17	#14...#8, #6...#4, #2	35, 45, 50	#14 ... #2	50
4.8	#18...#8	17	#14...#8, #6...#4, #2	35, 45, 50	#14 ... #2	50
4.8	#18...#8	17	#14...#8, #6...#4, #2	35, 45, 50	#14 ... #2	50
4.8	#14...#4	30...35	#14...#8, #6...#4, #2	35, 45, 50	#14 ... #2	50
4.8	#14...2/0	120	#14...#8, #6...#4, #2	35, 45, 50	#14 ... #2	50
4.8	#14...2/0	120	#14...#8, #6...#4, #2	35, 45, 50	#14 ... #2	50
4.8	#14...2/0	120	#14...#10, #8, #6...#4, #2	35, 40, 45, 50	#14 ... #2	50
4.8	#4...300 MCM	275	#14...#10, #8, #6...#4, #2	35, 40, 45, 50	#14 ... #2	50
4.8	#4...300 MCM	275	#14...#10, #8, #6...#4, #2	35, 40, 45, 50	#14 ... #2	50
4.8	#4...300 MCM	275	#6...300 MCM	25	#14 ... #2	50
4.8	#2...600 MCM	375	#6...300 MCM	25	#14 ... #2	50
4.8	#2...600 MCM	375	#4...400 MCM	31	#14 ... #2	50

1. The VFD Horsepower is for reference ONLY.

TABLE 45 - AYK580-CF+B058 (460 V)

HP ¹	JCI 460V PART NUMBER	ABB 460V PART NUMBER	"ACTUAL MINIMUM (AMPS)"	"MAXIMUM (AMPS)"	"MAX WIRE SIZE CONTROL (AWG)"	"TORQUE VAL- UES CONTROL TER- MINALS (LB-IN)"
1	024-41723-011	AYK580-CF-02A1-4+B058	0.8	2.1	#24...#16	4.8
1.5	024-41723-012	AYK580-CF-03A0-4+B058	1.9	3	#24...#16	4.8
2	024-41723-013	AYK580-CF-03A5-4+B058	1.9	3.5	#24...#16	4.8
3	024-41723-014	AYK580-CF-04A8-4+B058	1.9	4.8	#24...#16	4.8
5	024-41723-015	AYK580-CF-07A6-4+B058	5.7	7.6	#24...#16	4.8
7.5	024-41723-016	AYK580-CF-012A-4+B058	5.7	12	#24...#16	4.8
10	024-41724-005	AYK580-CF-014A-4+B058	5.7	14	#24...#16	4.8
15	024-41724-006	AYK580-CF-023A-4+B058	9	23	#24...#16	4.8
20	024-41725-005	AYK580-CF-027A-4+B058	9	27	#24...#16	4.8
25	024-41725-006	AYK580-CF-034A-4+B058	15	34	#24...#16	4.8
30	024-41725-007	AYK580-CF-044A-4+B058	15	44	#24...#16	4.8
40	024-41727-003	AYK580-CF-052A-4+B058	32	52	#24...#16	4.8
50	024-41727-004	AYK580-CF-065A-4+B058	32	65	#24...#16	4.8
60	024-41727-005	AYK580-CF-077A-4+B058	32	77	#24...#16	4.8
75	024-41728-005	AYK580-CF-096A-4+B058	32	96	#24...#16	4.8
100	024-41731-001	AYK580-CF-124A-4+B058	76	124	#24...#16	4.8
125	024-41732-005	AYK580-CF-156A-4+B058	26	156	#24...#16	4.8
150	024-41732-006	AYK580-CF-180A-4+B058	30	180	#24...#16	4.8

1. The VFD Horsepower is for reference ONLY.

TABLE 45 - AYK580-CF+B058 (460 V) (CONT'D)

INPUT DISCONNECT WIRE RANGE	"TERMINAL TORQUE (IN-LB)"	OUTPUT MOTOR WIRE RANGE	"TERMINAL TORQUE (IN-LB)"	INPUT & OUPUT GND WIRE RANGE	"TERMINAL TORQUE (IN-LB)"
#18...#8	17	#14...#8, #6...#4, #2	35, 45, 50	#14 ... #2	50
#18...#8	17	#14...#8, #6...#4, #2	35, 45, 50	#14 ... #2	50
#18...#8	17	#14...#8, #6...#4, #2	35, 45, 50	#14 ... #2	50
#18...#8	17	#14...#8, #6...#4, #2	35, 45, 50	#14 ... #2	50
#18...#8	17	#14...#8, #6...#4, #2	35, 45, 50	#14 ... #2	50
#18...#8	17	#14...#8, #6...#4, #2	35, 45, 50	#14 ... #2	50
#18...#8	17	#14...#8, #6...#4, #2	35, 45, 50	#14 ... #2	50
#18...#8	17	#14...#8, #6...#4, #2	35, 45, 50	#14 ... #2	50
#14...#4	30...35	#14...#8, #6...#4, #2	35, 45, 50	#14 ... #2	50
#14...#4	30...35	#14...#8, #6...#4, #2	35, 45, 50	#14 ... #2	50
#14...#4	30...35	#14...#8, #6...#4, #2	35, 45, 50	#14 ... #2	50
#14...2/0	120	#14...#10, #8, #6...#4, #2	35, 40, 45, 50	#14 ... #2	50
#14...2/0	120	#14...#10, #8, #6...#4, #2	35, 40, 45, 50	#14 ... #2	50
#4...300 MCM	275	#14...#10, #8, #6...#4, #2	35, 40, 45, 50	#14 ... #2	50
#4...300 MCM	275	#14...#10, #8, #6...#4, #2	35, 40, 45, 50	#14 ... #2	50
#4...300 MCM	275	#14...#10, #8, #6...#4, #2	35, 40, 45, 50	#14 ... #2	50
#2...600 MCM	375	#6...300 MCM	25	#14 ... #2	50
#2...600 MCM	375	#6...300 MCM	25	#14 ... #2	50

1. The VFD Horsepower is for reference ONLY.

TABLE 46 - AYK580-CF+B058 (575 V)

HP1	JCI 575V PART NUMBER	ABB 575V PART NUMBER	"ACTUAL MINIMUM (AMPS)"	"MAXIMUM (AMPS)"	"MAX WIRE SIZE CONTROL (AWG)"	"TORQUE VAL- UES CONTROL TER- MINALS (LB-IN)"
2	024-41724-007	AYK580-CF-02A7-6+B058	0.5	2.7	#24...#16	4.8
3	024-41724-008	AYK580-CF-03A9-6+B058	1.9	3.9	#24...#16	4.8
5	024-41724-009	AYK580-CF-06A1-6+B058	1.9	6.1	#24...#16	4.8
7.5	024-41724-010	AYK580-CF-09A0-6+B058	5.7	9	#24...#16	4.8
10	024-41724-011	AYK580-CF-011A-6+B058	5.7	11	#24...#16	4.8
15	024-41724-012	AYK580-CF-017A-6+B058	5.7	17	#24...#16	4.8
20	024-41725-008	AYK580-CF-022A-6+B058	9	22	#24...#16	4.8
25	024-41725-009	AYK580-CF-027A-6+B058	9	27	#24...#16	4.8
30	024-41726-001	AYK580-CF-032A-6+B058	15	32	#24...#16	4.8
40	024-41728-006	AYK580-CF-041A-6+B058	15	41	#24...#16	4.8
50	024-41728-007	AYK580-CF-052A-6+B058	32	52	#24...#16	4.8
60	024-41728-008	AYK580-CF-062A-6+B058	32	62	#24...#16	4.8
75	024-41729-001	AYK580-CF-077A-6+B058	32	77	#24...#16	4.8
100	024-41732-007	AYK580-CF-099A-6+B058	32	99	#24...#16	4.8
125	024-41732-008	AYK580-CF-125A-6+B058	76	125	#24///#16	4.8

1. The VFD Horsepower is for reference ONLY.

TABLE 46 - AYK580-CF+B058 (575 V) (CONT'D)

INPUT DISCONNECT WIRE RANGE	"TERMINAL TORQUE (IN-LB)"	OUTPUT MOTOR WIRE RANGE	"TERMINAL TORQUE (IN-LB)"	INPUT & OUPUT GND WIRE RANGE	"TERMINAL TORQUE (IN-LB)"
#18...#8	17	#14...#8, #6...#4, #2	35, 45, 50	#14 ... #2	50
#18...#8	17	#14...#8, #6...#4, #2	35, 45, 50	#14 ... #2	50
#18...#8	17	#14...#8, #6...#4, #2	35, 45, 50	#14 ... #2	50
#18...#8	17	#14...#8, #6...#4, #2	35, 45, 50	#14 ... #2	50
#18...#8	17	#14...#8, #6...#4, #2	35, 45, 50	#14 ... #2	50
#18...#8	17	#14...#8, #6...#4, #2	35, 45, 50	#14 ... #2	50
#14...#4	30...35	#14...#8, #6...#4, #2	35, 45, 50	#14 ... #2	50
#14...#4	30...35	#14...#8, #6...#4, #2	35, 45, 50	#14 ... #2	50
#14...#4	30...35	#14...#10, #8, #6...#4, #2	35, 40 ,45, 50	#14 ... #2	50
#14...#4	30...35	#14...#10, #8, #6...#4, #2	35, 40 ,45, 50	#14 ... #2	50
#14...2/0	120	#14...#10, #8, #6...#4, #2	35, 40 ,45, 50	#14 ... #2	50
#14...2/0	120	#14...#10, #8, #6...#4, #2	35, 40 ,45, 50	#14 ... #2	50
#4...300 MCM	275	#14...#10, #8, #6...#4, #2	35, 40 ,45, 50	#14 ... #2	50
#4...300 MCM	275	#14...#10, #8, #6...#4, #2	35, 40 ,45, 50	#14 ... #2	50
#4...300 MCM	275	#14...#10, #8, #6...#4, #2	35, 40 ,45, 50	#14 ... #2	50

1. The VFD Horsepower is for reference ONLY.

Appendix C

FUSE TABLES FOR NEMA 1/UL TYPE 1 - AYK580-01 BASE DRIVE (ONLY) (FUSES BY OTHERS)

TABLE 47 - AYK580-01 FUSE TABLES (208/230 V)

HP ¹	JCI 208V PART NUM- BER3	JCI 230V PART NUM- BER3	VENDOR 208/230V PART NUMBER3	DRIVE R FRAME	"MAXIMUM (AMPS)"	"LITTELFUSE, BUSSMANN, MERSEN RECOMMENDED FUSE PART NUM- BER2"	"FUSE SIZE (AMPS)"
1	024-41675-001	024-41675-006	AYK580-01-04A6-2	R1	4.6	KTK-R-15 or JJS-15	15
1.5	024-41675-002	024-41675-007	AYK580-01-06A6-2	R1	6.6	KTK-R-15 or JJS-15	15
2	024-41675-003	024-41675-008	AYK580-01-07A5-2	R1	7.5	KTK-R-15 or JJS-15	15
3	024-41675-004	024-41675-009	AYK580-01-10A6-2	R1	10.6	KTK-R-15 or JJS-15	15
5	024-41675-005	024-41675-010	AYK580-01-017A-2	R1	16.7	KTK-R-30 or JJS-30	30
7.5	024-41676-001	024-41676-003	AYK580-01-024A-2	R2	24.2	JJS-40	40
10	024-41676-002	024-41676-004	AYK580-01-031A-2	R2	30.8	JJS-40	40
15	024-41677-001	024-41677-003	AYK580-01-046A-2	R3	46.2	JJS-80	80
20	024-41677-002	024-41677-004	AYK580-01-059A-2	R3	59.4	JJS-80	80
25	024-41678-001	024-41678-002	AYK580-01-075A-2	R4	74.8	JJS-100	100
30	024-41679-001	024-41679-003	AYK580-01-088A-2	R5	88	JJS-150	150
40	024-41679-002	024-41679-004	AYK580-01-114A-2	R5	114	JJS-150	150
50	024-41680-001	024-41680-002	AYK580-01-143A-2	R6	143	JJS-200	200
60	024-41681-001	024-41681-003	AYK580-01-169A-2	R7	169	JJS-250	250
75	024-41681-002	024-41681-004	AYK580-01-211A-2	R7	211	JJS-300	300
100	024-41682-001	024-41682-002	AYK580-01-273A-2	R8	273	JJS-400	400

1. The VFD Horsepower is for reference ONLY

2. The VFD does not come as standard with drive input fusing. Drive input fuses are REQUIRED BY OTHERS to meet current UL61800-5-1

3. ALL VFD BASE DRIVES come standard with Nema 1 Conduit Box

TABLE 48 - AYK580-01 FUSE TABLES (460 V)

HP ¹	JCI 460V PART NUM- BER3	VENDOR 460V PART NUMBER3	"MAXIMUM (AMPS)"	DRIVE R FRAME	"LITTELFUSE, BUSS- MANN, MERSEN RECOMMENDED FUSE PART NUM- BER2"	"FUSE SIZE (AMPS)"
1	024-41675-011	AYK580-01-02A1-4	2.1	R1	KTK-R-15 or JJS-15	15
1.5	024-41675-012	AYK580-01-03A0-4	3	R1	KTK-R-15 or JJS-15	15
2	024-41675-013	AYK580-01-03A5-4	3.5	R1	KTK-R-15 or JJS-15	15
3	024-41675-014	AYK580-01-04A8-4	4.8	R1	KTK-R-15 or JJS-15	15
5	024-41675-015	AYK580-01-07A6-4	7.6	R1	KTK-R-15 or JJS-15	15
7.5	024-41675-016	AYK580-01-012A-4	12	R1	KTK-R-15 or JJS-15	15
10	024-41676-005	AYK580-01-014A-4	14	R2	KTK-R-30 or JJS-30	30
15	024-41676-006	AYK580-01-023A-4	23	R2	KTK-R-30 or JJS-30	30
20	024-41677-005	AYK580-01-027A-4	27	R3	JJS-40	40
25	024-41677-006	AYK580-01-034A-4	34	R3	JJS-60	60
30	024-41677-007	AYK580-01-044A-4	44	R3	JJS-60	60
40	024-41678-003	AYK580-01-052A-4	52	R4	JJS-80	80
50	024-41678-004	AYK580-01-065A-4	62	R4	JJS-100	100
60	024-41678-005	AYK580-01-077A-4	77	R4	JJS-100	100
75	024-41679-005	AYK580-01-096A-4	96	R5	JJS-150	150
100	024-41680-003	AYK580-01-124A-4	124	R6	JJS-200	200
125	024-41681-005	AYK580-01-156A-4	156	R7	JJS-225	225
150	024-41681-006	AYK580-01-180A-4	180	R7	JJS-300	300
200	024-41682-003	AYK580-01-240A-4	240	R8	JJS-350	350
250	024-41683-001	AYK580-01-302A-4	302	R9	JJS-500	500
300	024-41683-002	AYK580-01-361A-4	361	R9	JJS-500	500
350	024-41683-003	AYK580-01-414A-4	414	R9	JJS-600	600

1. The VFD Horsepower is for reference ONLY
2. The VFD does not come as standard with drive input fusing. Drive input fuses are REQUIRED BY OTHERS to meet current UL61800-5-1
3. ALL VFD BASE DRIVES come standard with Nema 1 Conduit Box

TABLE 49 - AYK580-01 FUSE TABLES (575 V)

HP1	JCI 575V PART NUMBER3	VENDOR 575V PART NUMBER3	"MAXIMUM (AMPS)"	DRIVE R FRAME	"LITTELFUSE, BUSS-MANN, MERSEN RECOMMENDED FUSE PART NUMBER2"	"FUSE SIZE (AMPS)"
2	024-41676-007	AYK580-01-02A7-6	2.7	R2	KTK-R-15 or JJS-15	15
3	024-41676-008	AYK580-01-03A9-6	3.9	R2	KTK-R-15 or JJS-15	15
5	024-41676-009	AYK580-01-06A1-6	6.1	R2	KTK-R-15 or JJS-15	15
7.5	024-41676-010	AYK580-01-09A0-6	9	R2	KTK-R-15 or JJS-15	15
10	024-41676-011	AYK580-01-011A-6	11	R2	KTK-R-15 or JJS-15	15
15	024-41676-012	AYK580-01-017A-6	17	R2	KTK-R-30 or JJS-30	30
20	024-41677-008	AYK580-01-022A-6	22	R3	JJS-40	40
25	024-41677-009	AYK580-01-027A-6	27	R3	JJS-40	40
30	024-41677-010	AYK580-01-032A-6	32	R3	JJS-40	40
40	024-41679-006	AYK580-01-041A-6	41	R5	JJS-100	100
50	024-41679-007	AYK580-01-052A-6	52	R5	JJS-100	100
60	024-41679-008	AYK580-01-062A-6	62	R5	JJS-100	100
75	024-41679-009	AYK580-01-077A-6	77	R5	JJS-100	100
100	024-41681-007	AYK580-01-099A-6	99	R7	JJS-150	150
125	024-41681-008	AYK580-01-125A-6	125	R7	JJS-200	200
150	024-41682-004	AYK580-01-144A-6	144	R8	JJS-250	250
200	024-41683-004	AYK580-01-192A-6	192	R9	JJS-300	300
250	024-41683-005	AYK580-01-242A-6	242	R9	JJS-400	400
250	024-41683-006	AYK580-01-271A-6	271	R9	JJS-400	400

1. The VFD Horsepower is for reference ONLY

2. The VFD does not come as standard with drive input fusing. Drive input fuses are REQUIRED BY OTHERS to meet current UL61800-5-1

3. ALL VFD BASE DRIVES come standard with Nema 1 Conduit Box

FUSE TABLES FOR NEMA 1/UL TYPE 1 - AYK580-PF DRIVE WITH MAIN FUSED DISCONNECT (ONLY)

TABLE 50 - AYK580-PF FUSE TABLES (208/230 V)

HP ¹	JCI 208V PART NUMBER	JCI 230V PART NUMBER	VENDOR 208/230V PART NUMBER	"MAXI- MUM (AMPS)"	"LITTELFUSE, BUSSMANN, MERSEN FUSE PART NUMBER"	"FUSE SIZE (AMPS)"
1	024-41684-001	024-41684-006	AYK580-PF-04A6-2	4.6	KLKR15, KTK-R-15, ATMR15	15
1.5	024-41684-002	024-41684-007	AYK580-PF-06A6-2	6.6	KLKR15, KTK-R-15, ATMR15	15
2	024-41684-003	024-41684-008	AYK580-PF-07A5-2	7.5	KLKR15, KTK-R-15, ATMR15	15
3	024-41684-004	024-41684-009	AYK580-PF-10A6-2	10.6	KLKR15, KTK-R-15, ATMR15	15
5	024-41684-005	024-41684-010	AYK580-PF-017A-2	16.7	KLKR30, KTK-R-30, ATMR30	30
7.5	024-41685-001	024-41685-003	AYK580-PF-024A-2	24.2	KLKR30, KTK-R-30, ATMR30	30
10	024-41685-002	024-41685-004	AYK580-PF-031A-2	30.8	JLS40, JKS-40, A4J40	40
15	024-41686-001	024-41686-003	AYK580-PF-046A-2	46.2	JLS80, JKS-80, A4J80	80
20	024-41686-002	024-41686-004	AYK580-PF-059A-2	59.4	JLS80, JKS-80, A4J80	80
25	024-41688-001	024-41688-002	AYK580-PF-075A-2	74.8	JLS100, JKS-100, A4J100	100
30	024-41689-001	024-41689-003	AYK580-PF-088A-2	88	JLS110, JKS-110, A4J110	110
40	024-41689-002	024-41689-004	AYK580-PF-114A-2	114	JLS150, JKS-150, A4J150	150
50	024-41691-001	024-41691-002	AYK580-PF-143A-2	143	JLS200, JKS-200, A4J200	200
60	024-41693-001	024-41693-003	AYK580-PF-169A-2	169	JLS250, JKS-250, A4J250	250
75	024-41693-002	024-41693-004	AYK580-PF-211A-2	211	JLS300, JKS-300, A4J300	300

1. The VFD Horsepower is for reference ONLY

TABLE 51 - AYK580-PF FUSE TABLES (460 V)

HP ¹	JCI 460V PART NUMBER	VENDOR 460V PART NUMBER	"MAXIMUM (AMPS)"	"LITTELFUSE, BUSSMANN, MERSEN FUSE PART NUMBER"	"FUSE SIZE (AMPS)"
1	024-41684-011	AYK580-PF-02A1-4	2.1	KLKR15, KTK-R-15, ATMR15	15
1.5	024-41684-012	AYK580-PF-03A0-4	3	KLKR15, KTK-R-15, ATMR15	15
2	024-41684-013	AYK580-PF-03A5-4	3.5	KLKR15, KTK-R-15, ATMR15	15
3	024-41684-014	AYK580-PF-04A8-4	4.8	KLKR15, KTK-R-15, ATMR15	15
5	024-41684-015	AYK580-PF-07A6-4	7.6	KLKR15, KTK-R-15, ATMR15	15
7.5	024-41684-016	AYK580-PF-012A-4	12	KLKR15, KTK-R-15, ATMR15	15
10	024-41685-005	AYK580-PF-014A-4	14	KLKR30, KTK-R-30, ATMR30	30
15	024-41685-006	AYK580-PF-023A-4	23	KLKR30, KTK-R-30, ATMR30	30
20	024-41686-005	AYK580-PF-027A-4	27	JLS40, JKS-40, A4J40	40
25	024-41686-006	AYK580-PF-034A-4	34	JLS60, JKS-60, A4J60	60
30	024-41686-007	AYK580-PF-044A-4	44	JLS60, JKS-60, A4J60	60
40	024-41688-003	AYK580-PF-052A-4	52	JLS80, JKS-80, A4J80	80
50	024-41688-004	AYK580-PF-065A-4	65	JLS100, JKS-100, A4J100	100
60	024-41688-005	AYK580-PF-077A-4	77	JLS100, JKS-100, A4J100	100
75	024-41689-005	AYK580-PF-096A-4	96	JLS150, JKS-150, A4J150	150
100	024-41692-001	AYK580-PF-124A-4	124	JLS200, JKS-200, A4J200	200
125	024-41693-005	AYK580-PF-156A-4	156	JLS225, JKS-225, A4J225	225
150	024-41693-006	AYK580-PF-180A-4	180	JLS300, JKS-300, A4J300	300

1. The VFD Horsepower is for reference ONLY

TABLE 52 - AYK580-PF FUSE TABLES (575 V)

HP ¹	JCI 575V PART NUMBER	VENDOR 575V PART NUMBER	"MAXIMUM (AMPS)"	"LITTELFUSE, BUSS- MANN, MERSEN FUSE PART NUMBER"	"FUSE SIZE (AMPS)"
2	024-41685-007	AYK580-PF-02A7-6	2.7	KLKR15, KTK-R-15, ATMR15	15
3	024-41685-008	AYK580-PF-03A9-6	3.9	KLKR15, KTK-R-15, ATMR15	15
5	024-41685-009	AYK580-PF-06A1-6	6.1	KLKR15, KTK-R-15, ATMR15	15
7.5	024-41685-010	AYK580-PF-09A0-6	9	KLKR15, KTK-R-15, ATMR15	15
10	024-41685-011	AYK580-PF-011A-6	11	KLKR30, KTK-R-30, ATMR30	30
15	024-41685-012	AYK580-PF-017A-6	17	KLKR30, KTK-R-30, ATMR30	30
20	024-41686-008	AYK580-PF-022A-6	22	JLS40, JKS-40, A4J40	40
25	024-41686-009	AYK580-PF-027A-6	27	JLS40, JKS-40, A4J40	40
30	024-41687-001	AYK580-PF-032A-6	32	JLS40, JKS-40, A4J40	40
40	024-41689-006	AYK580-PF-041A-6	41	JLS50, JKS-50, A4J50	50
50	024-41689-007	AYK580-PF-052A-6	52	JLS80, JKS-80, A4J80	80
60	024-41689-008	AYK580-PF-062A-6	62	JLS80, JKS-80, A4J80	80
75	024-41690-001	AYK580-PF-077A-6	77	JLS100, JKS-100, A4J100	100
100	024-41693-007	AYK580-PF-099A-6	99	JLS150, JKS-150, A4J150	150
125	024-41693-008	AYK580-PF-125A-6	125	JLS175, JKS-175, A4J175	175

1. The VFD Horsepower is for reference ONLY

FUSE TABLES FOR NEMA 1/UL TYPE 1 - AYK580-CF DRIVE WITH 2 CONTACTOR CLASSIC BYPASS, MAIN FUSED DISCONNECT AND FUSED SERVICE SWITCH

TABLE 53 - AYK580-CF FUSE TABLES (208/230 V)

HP1	JCI 208V PART NUMBER	JCI 230V PART NUMBER	VENDOR 208/230V PART NUMBER	"MAXIMUM (AMPS)"	"LITTELFUSE, BUSS- MANN, MERSEN FUSE PART NUMBER"	"FUSE SIZE (AMPS)"
1	024-41713-001	024-41713-006	AYK580-PF-04A6-2+B058	4.6	KLKR15, KTK-R-15, ATMR15	15
1.5	024-41713-002	024-41713-007	AYK580-PF-06A6-2+B058	6.6	KLKR15, KTK-R-15, ATMR15	15
2	024-41713-003	024-41713-008	AYK580-PF-07A5-2+B058	7.5	KLKR15, KTK-R-15, ATMR15	15
3	024-41713-004	024-41713-009	AYK580-PF-10A6-2+B058	10.6	KLKR15, KTK-R-15, ATMR15	15
5	024-41713-005	024-41713-010	AYK580-PF-017A-2+B058	16.7	KLKR30, KTK-R-30, ATMR30	30
7.5	024-41714-001	024-41714-003	AYK580-PF-024A-2+B058	24.2	KLKR30, KTK-R-30, ATMR30	30
10	024-41714-002	024-41714-004	AYK580-PF-031A-2+B058	30.8	JLS40, JKS-40, A4J40	40
15	024-41715-001	024-41715-003	AYK580-PF-046A-2+B058	46.2	JLS80, JKS-80, A4J80	80
20	024-41715-002	024-41715-004	AYK580-PF-059A-2+B058	59.4	JLS80, JKS-80, A4J80	80
25	024-41717-001	024-41717-002	AYK580-PF-075A-2+B058	74.8	JLS100, JKS-100, A4J100	100
30	024-41718-001	024-41718-003	AYK580-PF-088A-2+B058	88	JLS110, JKS-110, A4J110	110
40	024-41718-002	024-41718-004	AYK580-PF-114A-2+B058	114	JLS150, JKS-150, A4J150	150
50	024-41720-001	024-41720-002	AYK580-PF-143A-2+B058	143	JLS200, JKS-200, A4J200	200
60	024-41722-001	024-41722-003	AYK580-PF-169A-2+B058	169	JLS250, JKS-250, A4J250	250
75	024-41722-002	024-41722-004	AYK580-PF-211A-2+B058	211	JLS300, JKS-300, A4J300	300

1. The VFD Horsepower is for reference ONLY

TABLE 54 - AYK580-CF FUSE TABLES (460 V)

HP1	JCI 460V PART NUMBER	VENDOR 460V PART NUMBER	"MAXIMUM (AMPS)"	"LITTELFUSE, BUSSMANN, MERSEN FUSE PART NUMBER"	"FUSE SIZE (AMPS)"
1	024-41713-011	AYK580-PF-02A1-4+B058	2.1	KLKR15, KTK-R-15, ATMR15	15
1.5	024-41713-012	AYK580-PF-03A0-4+B058	3	KLKR15, KTK-R-15, ATMR15	15
2	024-41713-013	AYK580-PF-03A5-4+B058	3.5	KLKR15, KTK-R-15, ATMR15	15
3	024-41713-014	AYK580-PF-04A8-4+B058	4.8	KLKR15, KTK-R-15, ATMR15	15
5	024-41713-015	AYK580-PF-07A6-4+B058	7.6	KLKR15, KTK-R-15, ATMR15	15
7.5	024-41713-016	AYK580-PF-012A-4+B058	12	KLKR15, KTK-R-15, ATMR15	15
10	024-41714-005	AYK580-PF-014A-4+B058	14	KLKR30, KTK-R-30, ATMR30	30
15	024-41714-006	AYK580-PF-023A-4+B058	23	KLKR30, KTK-R-30, ATMR30	30
20	024-41715-005	AYK580-PF-027A-4+B058	27	JLS40, JKS-40, A4J40	40
25	024-41715-006	AYK580-PF-034A-4+B058	34	JLS60, JKS-60, A4J60	60
30	024-41715-007	AYK580-PF-044A-4+B058	44	JLS60, JKS-60, A4J60	60
40	024-41717-003	AYK580-PF-052A-4+B058	52	JLS80, JKS-80, A4J80	80
50	024-41717-004	AYK580-PF-065A-4+B058	65	JLS100, JKS-100, A4J100	100
60	024-41717-005	AYK580-PF-077A-4+B058	77	JLS100, JKS-100, A4J100	100
75	024-41718-005	AYK580-PF-096A-4+B058	96	JLS150, JKS-150, A4J150	150
100	024-41721-001	AYK580-PF-124A-4+B058	124	JLS200, JKS-200, A4J200	200
125	024-41722-005	AYK580-PF-156A-4+B058	156	JLS225, JKS-225, A4J225	225
150	024-41722-006	AYK580-PF-180A-4+B058	180	JLS300, JKS-300, A4J300	300

1. The VFD Horsepower is for reference ONLY

TABLE 55 - AYK580-CF FUSE TABLES (575 V)

HP ¹	JCI 575V PART NUMBER	VENDOR 575V PART NUMBER	"MAXIMUM (AMPS)"	"LITTELFUSE, BUSSMANN, MERSEN FUSE PART NUMBER"	"FUSE SIZE (AMPS)"
2	024-41714-007	AYK580-PF-02A7-6+B058	2.7	KLKR15, KTK-R-15, ATMR15	15
3	024-41714-008	AYK580-PF-03A9-6+B058	3.9	KLKR15, KTK-R-15, ATMR15	15
5	024-41714-009	AYK580-PF-06A1-6+B058	6.1	KLKR15, KTK-R-15, ATMR15	15
7.5	024-41714-010	AYK580-PF-09A0-6+B058	9	KLKR15, KTK-R-15, ATMR15	15
10	024-41714-011	AYK580-PF-011A-6+B058	11	KLKR30, KTK-R-30, ATMR30	30
15	024-41714-012	AYK580-PF-017A-6+B058	17	KLKR30, KTK-R-30, ATMR30	30
20	024-41715-008	AYK580-PF-022A-6+B058	22	JLS40, JKS-40, A4J40	40
25	024-41715-009	AYK580-PF-027A-6+B058	27	JLS40, JKS-40, A4J40	40
30	024-41716-001	AYK580-PF-032A-6+B058	32	JLS40, JKS-40, A4J40	40
40	024-41718-006	AYK580-PF-041A-6+B058	41	JLS50, JKS-50, A4J50	50
50	024-41718-007	AYK580-PF-052A-6+B058	52	JLS80, JKS-80, A4J80	80
60	024-41718-008	AYK580-PF-062A-6+B058	62	JLS80, JKS-80, A4J80	80
75	024-41719-001	AYK580-PF-077A-6+B058	77	JLS100, JKS-100, A4J100	100
100	024-41722-007	AYK580-PF-099A-6+B058	99	JLS150, JKS-150, A4J150	150
125	024-41722-008	AYK580-PF-125A-6+B058	125	JLS175, JKS-175, A4J175	175

1. The VFD Horsepower is for reference ONLY

FUSE TABLES FOR NEMA R/UL TYPE 3R - AYK580-PF DRIVE WITH MAIN FUSED DISCONNECT (ONLY)

TABLE 56 - AYK580-PF+B058 FUSE TABLES (208/230 V)

HP ¹	JCI 208V PART NUMBER	JCI 230V PART NUMBER	ABB 208/230V PART NUMBER	"ACTUAL MINIMUM (AMPS)"	"MAXIMUM (AMPS)"	"MAIN FUSED SWITCH LITTELFUSE, BUSSMANN, MERSEN FUSE PART NUMBER"	"MAIN DISC. FUSE SIZE (AMPS)"	"FUSED SERVICE SWITCH LITTELFUSE, BUSSMANN, MERSEN FUSE PART NUMBER"	SERVICE SWITCH FUSE SIZE (AMPS)
1	024-41694-001	024-41694-006	AYK580-CF-04A6-2	1.9	4.6	KLDR7, LP-CC-7, ATDR7	7	KLKR15, KTK-R-15, ATMR15	15
1.5	024-41694-002	024-41694-007	AYK580-CF-06A6-2	5.7	6.6	KLDR10, LP-CC-10, ATDR10	10	KLKR15, KTK-R-15, ATMR15	15
2	024-41694-003	024-41694-008	AYK580-CF-07A5-2	5.7	7.5	KLDR12, LP-CC-12, ATDR12	12	KLKR15, KTK-R-15, ATMR15	15
3	024-41694-004	024-41694-009	AYK580-CF-10A6-2	5.7	10.6	KLDR17.5, LP-CC-17.5, ATDR17.5	17.5	KLKR15, KTK-R-15, ATMR15	15
5	024-41694-005	024-41694-010	AYK580-CF-017A-2	5.7	16.7	KLDR25, LP-CC-25, ATDR25	25	KLKR30, KTK-R-30, ATMR30	30
7.5	024-41695-001	024-41695-003	AYK580-CF-024A-2	9	24.2	KLDR30, LP-CC-30, ATDR30	30	KLKR30, KTK-R-30, ATMR30	30
10	024-41695-002	024-41695-004	AYK580-CF-031A-2	15	30.8	JTD50, LPJ-50SP, AJT50	50	JLS40, JKS-40, A4J40	40
15	024-41696-001	024-41696-003	AYK580-CF-046A-2	32	46.2	JTD70, LPJ-70SP, AJT70	70	JLS80, JKS-80, A4J80	80
20	024-41696-002	024-41696-004	AYK580-CF-059A-2	32	59.4	JTD100, LPJ-100SP, AJT100	100	JLS80, JKS-80, A4J80	80
25	024-41698-001	024-41698-002	AYK580-CF-075A-2	32	74.8	JTD100, LPJ-100SP, AJT100	100	JLS100, JKS-100, A4J100	100
30	024-41699-001	024-41699-003	AYK580-CF-088A-2	32	88	JTD150, LPJ-150SP, AJT150	150	JLS110, JKS-110, A4J110	110
40	024-41699-002	024-41699-004	AYK580-CF-114A-2	76	114	JTD175, LPJ-175SP, AJT175	175	JLS150, JKS-150, A4J150	150
50	024-41701-001	024-41701-002	AYK580-CF-143A-2	76	143	JTD200, LPJ-200SP, AJT200	200	JLS200, JKS-200, A4J200	200
60	024-41703-001	024-41703-003	AYK580-CF-169A-2	76	169	JTD250, LPJ-250SP, AJT250	250	JLS250, JKS-250, A4J250	250
75	024-41703-002	024-41703-004	AYK580-CF-211A-2	76	211	JTD350, LPJ-350SP, AJT350	350	JLS300, JKS-300, A4J300	300

1. The VFD Horsepower is for reference ONLY

TABLE 57 - AYK580-PF+B058 FUSE TABLES (460 V)

HP ¹	JCI 460V PART NUM- BER	ABB 460V PART NUM- BER	"AC- TUAL MINI- MUM (AMPS)"	"MAXI- MUM (AMPS)"	"MAIN FUSED SWITCH LITTEL- FUSE, BUSSMANN, MERSEN FUSE PART NUM- BER"	"MAIN DISC. FUSE SIZE (AMPS)"	"FUSED SERVICE SWITCH LITTEL- FUSE, BUSSMANN, MERSEN FUSE PART NUM- BER"	SERVICE SWITCH FUSE SIZE (AMPS)
1	024-41694-011	AYK580-CF-02A1-4	0.8	2.1	KLDR5, LP-CC-5, ATDR5	5	KLKR15, KTK-R-15, ATMR15	15
1.5	024-41694-012	AYK580-CF-03A0-4	1.9	3	KLDR5, LP-CC-5, ATDR5	5	KLKR15, KTK-R-15, ATMR15	15
2	024-41694-013	AYK580-CF-03A5-4	1.9	3.5	KLDR7, LP-CC-7, ATDR7	7	KLKR15, KTK-R-15, ATMR15	15
3	024-41694-014	AYK580-CF-04A8-4	1.9	4.8	KLDR9, LP-CC-9, ATDR9	9	KLKR15, KTK-R-15, ATMR15	15
5	024-41694-015	AYK580-CF-07A6-4	5.7	7.6	KLDR12, LP-CC-12, ATDR12	12	KLKR15, KTK-R-15, ATMR15	15
7.5	024-41694-016	AYK580-CF-012A-4	5.7	12	KLDR17.5, LP-CC-17.5, ATDR17.5	17.5	KLKR15, KTK-R-15, ATMR15	15
10	024-41695-005	AYK580-CF-014A-4	5.7	14	KLDR20, LP-CC-20, ATDR20	20	KLKR30, KTK-R-30, ATMR30	30
15	024-41695-006	AYK580-CF-023A-4	9	23	KLDR30, LP-CC-30, ATDR30	30	KLKR30, KTK-R-30, ATMR30	30
20	024-41696-005	AYK580-CF-027A-4	9	27	JTD40, LPJ-40SP, AJT40	40	JLS40, JKS-40, A4J40	40
25	024-41696-006	AYK580-CF-034A-4	15	34	JTD50, LPJ-50SP, AJT50	50	JLS60, JKS-60, A4J60	60
30	024-41696-007	AYK580-CF-044A-4	15	44	JTD60, LPJ-60SP, AJT60	60	JLS60, JKS-60, A4J60	60
40	024-41698-003	AYK580-CF-052A-4	32	52	JTD90, LPJ-90SP, AJT90	90	JLS80, JKS-80, A4J80	80
50	024-41698-004	AYK580-CF-065A-4	32	65	JTD100, LPJ-100SP, AJT100	100	JLS100, JKS-100, A4J100	100
60	024-41698-005	AYK580-CF-077A-4	32	77	JTD125, LPJ-125SP, AJT125	125	JLS100, JKS-100, A4J100	100
75	024-41699-005	AYK580-CF-096A-4	32	96	JTD150, LPJ-150SP, AJT150	150	JLS150, JKS-150, A4J150	150
100	024-41702-001	AYK580-CF-124A-4	76	124	JTD200, LPJ-200SP, AJT200	200	JLS200, JKS-200, A4J200	200
125	024-41703-005	AYK580-CF-156A-4	26	156	JTD250, LPJ-250SP, AJT250	250	JLS225, JKS-225, A4J225	225
150	024-41703-006	AYK580-CF-180A-4	30	180	JTD300, LPJ-300SP, AJT300	300	JLS300, JKS-300, A4J300	300

1. The VFD Horsepower is for reference ONLY

TABLE 58 - AYK580-PF+B058 FUSE TABLES (575 V)

HP ¹	JCI PART NUMBER	ABB PART NUMBER	"ACTUAL MINIMUM (AMPS)"	"MAXIMUM (AMPS)"	"MAIN FUSED SWITCH LITTELFUSE, BUSSMANN, MERSEN FUSE PART NUMBER"	"MAIN DISC. FUSE SIZE (AMPS)"	"FUSED SERVICE SWITCH LITTELFUSE, BUSSMANN, MERSEN FUSE PART NUMBER"	SERVICE SWITCH FUSE SIZE (AMPS)
2	024-41695-007	AYK580-CF-02A7-6	0.5	2.7	KLDR5, LP-CC-5, ATDR5	5	KLKR15, KTKR-15, ATMR15	15
3	024-41695-008	AYK580-CF-03A9-6	1.9	3.9	KLDR6, LP-CC-6, ATDR6	6	KLKR15, KTKR-15, ATMR15	15
5	024-41695-009	AYK580-CF-06A1-6	1.9	6.1	KLDR10, LP-CC-10, ATDR10	10	KLKR15, KTKR-15, ATMR15	15
7.5	024-41695-010	AYK580-CF-09A0-6	5.7	9	KLDR15, LP-CC-15, ATDR15	15	KLKR15, KTKR-15, ATMR15	15
10	024-41695-011	AYK580-CF-011A-6	5.7	11	KLDR17.5, LP-CC-17.5, ATDR17.5	17.5	KLKR30, KTKR-30, ATMR30	30
15	024-41695-012	AYK580-CF-017A-6	5.7	17	KLDR25, LP-CC-25, ATDR25	25	KLKR30, KTKR-30, ATMR30	30
20	024-41696-008	AYK580-CF-022A-6	9	22	KLDR30, LP-CC-30, ATDR30	30	JLS40, JKS-40, A4J40	40
25	024-41696-009	AYK580-CF-027A-6	9	27	JTD40, LPJ-40SP, AJT40	40	JLS40, JKS-40, A4J40	40
30	024-41697-001	AYK580-CF-032A-6	15	32	JTD50, LPJ-50SP, AJT50	50	JLS40, JKS-40, A4J40	40
40	024-41699-006	AYK580-CF-041A-6	15	41	JTD60, LPJ-60SP, AJT60	60	JLS50, JKS-50, A4J50	50
50	024-41699-007	AYK580-CF-052A-6	32	52	JTD90, LPJ-90SP, AJT90	90	JLS80, JKS-80, A4J80	80
60	024-41699-008	AYK580-CF-062A-6	32	62	JTD100, LPJ-100SP, AJT100	100	JLS80, JKS-80, A4J80	80
75	024-41700-001	AYK580-CF-077A-6	32	77	JTD125, LPJ-125SP, AJT125	125	JLS100, JKS-100, A4J100	100
100	024-41703-007	AYK580-CF-099A-6	32	99	JTD150, LPJ-150SP, AJT150	150	JLS150, JKS-150, A4J150	150
125	024-41703-008	AYK580-CF-125A-6	76	125	JTD200, LPJ-200SP, AJT200	200	JLS175, JKS-175, A4J175	175

1. The VFD Horsepower is for reference ONLY

FUSE TABLES FOR NEMA R/UL TYPE 3R - AYK580-CF DRIVE WITH 2 CONTACTOR CLASSIC BYPASS, MAIN FUSED DISCONNECT, AND FUSED SERVICE SWITCH

TABLE 59 - AYK580-CF+B058 FUSE TABLES (208/230 V)

HP ¹	JCI 208V PART NUMBER	JCI 230V PART NUMBER	ABB 208/230 PART NUMBER	"ACTUAL MINIMUM (AMPS)"	"MAXIMUM (AMPS)"	"MAIN FUSED SWITCH LITTELFUSE, BUSSMANN, MERSEN FUSE PART NUMBER"	"MAIN DISC. FUSE SIZE (AMPS)"	"FUSED SERVICE SWITCH LITTELFUSE, BUSSMANN, MERSEN FUSE PART NUMBER"	SERVICE SWITCH FUSE SIZE (AMPS)
1	024-41723-001	024-41723-006	AYK580-CF-04A6-2+B058	1.9	4.6	KLDR7, LP-CC-7, ATDR7	7	KLKR15, KTKR-15, ATMR15	15
1.5	024-41723-002	024-41723-007	AYK580-CF-06A6-2+B058	5.7	6.6	KLDR10, LP-CC-10, ATDR10	10	KLKR15, KTKR-15, ATMR15	15
2	024-41723-003	024-41723-008	AYK580-CF-07A5-2+B058	5.7	7.5	KLDR12, LP-CC-12, ATDR12	12	KLKR15, KTKR-15, ATMR15	15
3	024-41723-004	024-41723-009	AYK580-CF-10A6-2+B058	5.7	10.6	KLDR17.5, LP-CC-17.5, ATDR17.5	17.5	KLKR15, KTKR-15, ATMR15	15
5	024-41723-005	024-41723-010	AYK580-CF-017A-2+B058	5.7	16.7	KLDR25, LP-CC-25, ATDR25	25	KLKR30, KTKR-30, ATMR30	30
7.5	024-41724-001	024-41724-003	AYK580-CF-024A-2+B058	9	24.2	KLDR30, LP-CC-30, ATDR30	30	KLKR30, KTKR-30, ATMR30	30
10	024-41724-002	024-41724-004	AYK580-CF-031A-2+B058	15	30.8	JTD50, LPJ-50SP, AJT50	50	JLS40, JKS-40, A4J40	40
15	024-41725-001	024-41725-003	AYK580-CF-046A-2+B058	32	46.2	JTD70, LPJ-70SP, AJT70	70	JLS80, JKS-80, A4J80	80
20	024-41725-002	024-41725-004	AYK580-CF-059A-2+B058	32	59.4	JTD100, LPJ-100SP, AJT100	100	JLS80, JKS-80, A4J80	80
25	024-41727-001	024-41727-002	AYK580-CF-075A-2+B058	32	74.8	JTD100, LPJ-100SP, AJT100	100	JLS100, JKS-100, A4J100	100
30	024-41728-001	024-41728-003	AYK580-CF-088A-2+B058	32	88	JTD150, LPJ-150SP, AJT150	150	JLS110, JKS-110, A4J110	110
40	024-41728-002	024-41728-004	AYK580-CF-114A-2+B058	76	114	JTD175, LPJ-175SP, AJT175	175	JLS150, JKS-150, A4J150	150
50	024-41730-001	024-41730-002	AYK580-CF-143A-2+B058	76	143	JTD200, LPJ-200SP, AJT200	200	JLS200, JKS-200, A4J200	200
60	024-41732-001	024-41732-003	AYK580-CF-169A-2+B058	76	169	JTD250, LPJ-250SP, AJT250	250	JLS250, JKS-250, A4J250	250
75	024-41732-002	024-41732-004	AYK580-CF-211A-2+B058	76	211	JTD350, LPJ-350SP, AJT350	350	JLS300, JKS-300, A4J300	300

1. The VFD Horsepower is for reference ONLY

TABLE 60 - AYK580-CF+B058 FUSE TABLES (460 V)

HP ¹	JCI 460V PART NUMBER	ABB 460V PART NUMBER	"ACTUAL MINIMUM (AMPS)"	"MAXIMUM (AMPS)"	"MAIN FUSED SWITCH LITTELFUSE, BUSSMANN, MERSEN FUSE PART NUMBER"	"MAIN DISC. FUSE SIZE (AMPS)"	"FUSED SERVICE SWITCH LITTELFUSE, BUSSMANN, MERSEN FUSE PART NUMBER"	SERVICE SWITCH FUSE SIZE (AMPS)
1	024-41723-011	AYK580-CF-02A1-4+B058	0.8	2.1	KLDR5, LP-CC-5, ATDR5	5	KLKR15, KTK-R-15, ATMR15	15
1.5	024-41723-012	AYK580-CF-03A0-4+B058	1.9	3	KLDR5, LP-CC-5, ATDR5	5	KLKR15, KTK-R-15, ATMR15	15
2	024-41723-013	AYK580-CF-03A5-4+B058	1.9	3.5	KLDR7, LP-CC-7, ATDR7	7	KLKR15, KTK-R-15, ATMR15	15
3	024-41723-014	AYK580-CF-04A8-4+B058	1.9	4.8	KLDR9, LP-CC-9, ATDR9	9	KLKR15, KTK-R-15, ATMR15	15
5	024-41723-015	AYK580-CF-07A6-4+B058	5.7	7.6	KLDR12, LP-CC-12, ATDR12	12	KLKR15, KTK-R-15, ATMR15	15
7.5	024-41723-016	AYK580-CF-012A-4+B058	5.7	12	KLDR17.5, LP-CC-17.5, ATDR17.5	17.5	KLKR15, KTK-R-15, ATMR15	15
10	024-41724-005	AYK580-CF-014A-4+B058	5.7	14	KLDR20, LP-CC-20, ATDR20	20	KLKR30, KTK-R-30, ATMR30	30
15	024-41724-006	AYK580-CF-023A-4+B058	9	23	KLDR30, LP-CC-30, ATDR30	30	KLKR30, KTK-R-30, ATMR30	30
20	024-41725-005	AYK580-CF-027A-4+B058	9	27	JTD40, LPJ-40SP, AJT40	40	JLS40, JKS-40, A4J40	40
25	024-41725-006	AYK580-CF-034A-4+B058	15	34	JTD50, LPJ-50SP, AJT50	50	JLS60, JKS-60, A4J60	60
30	024-41725-007	AYK580-CF-044A-4+B058	15	44	JTD60, LPJ-60SP, AJT60	60	JLS60, JKS-60, A4J60	60
40	024-41727-003	AYK580-CF-052A-4+B058	32	52	JTD90, LPJ-90SP, AJT90	90	JLS80, JKS-80, A4J80	80
50	024-41727-004	AYK580-CF-065A-4+B058	32	65	JTD100, LPJ-100SP, AJT100	100	JLS100, JKS-100, A4J100	100
60	024-41727-005	AYK580-CF-077A-4+B058	32	77	JTD125, LPJ-125SP, AJT125	125	JLS100, JKS-100, A4J100	100
75	024-41728-005	AYK580-CF-096A-4+B058	32	96	JTD150, LPJ-150SP, AJT150	150	JLS150, JKS-150, A4J150	150
100	024-41731-001	AYK580-CF-124A-4+B058	76	124	JTD200, LPJ-200SP, AJT200	200	JLS200, JKS-200, A4J200	200
125	024-41732-005	AYK580-CF-156A-4+B058	26	156	JTD250, LPJ-250SP, AJT250	250	JLS225, JKS-225, A4J225	225
150	024-41732-006	AYK580-CF-180A-4+B058	30	180	JTD300, LPJ-300SP, AJT300	300	JLS300, JKS-300, A4J300	300

1. The VFD Horsepower is for reference ONLY

TABLE 61 - AYK580-CF+B058 FUSE TABLES (575 V)

HP1	JCI 575V PART NUM- BER	ABB 575V PART NUM- BER	"ACTUAL MINIMUM (AMPS)"	"MAXI- MUM (AMPS)"	"MAIN FUSED SWITCH LITTEL- FUZE, BUSS- MANN, MERSEN FUZE PART NUM- BER"	"MAIN DISC. FUZE SIZE (AMPS)"	"FUSED SER- VICE SWITCH LITTELFUZE, BUSSMANN, MERSEN FUZE PART NUMBER"	SERVICE SWITCH FUZE SIZE (AMPS)
2	024-41724- 007	AYK580-CF- 02A7-6+B058	0.5	2.7	KLDR5, LP-CC-5, ATDR5	5	KLKR15, KTK- R-15, ATMR15	15
3	024-41724- 008	AYK580-CF- 03A9-6+B058	1.9	3.9	KLDR6, LP-CC-6, ATDR6	6	KLKR15, KTK- R-15, ATMR15	15
5	024-41724- 009	AYK580-CF- 06A1-6+B058	1.9	6.1	KLDR10, LP- CC-10, ATDR10	10	KLKR15, KTK- R-15, ATMR15	15
7.5	024-41724- 010	AYK580-CF- 09A0-6+B058	5.7	9	KLDR15, LP- CC-15, ATDR15	15	KLKR15, KTK- R-15, ATMR15	15
10	024-41724- 011	AYK580-CF- 011A-6+B058	5.7	11	KLDR17.5, LP- CC-17.5, ATDR17.5	17.5	KLKR30, KTK- R-30, ATMR30	30
15	024-41724- 012	AYK580-CF- 017A-6+B058	5.7	17	KLDR25, LP- CC-25, ATDR25	25	KLKR30, KTK- R-30, ATMR30	30
20	024-41725- 008	AYK580-CF- 022A-6+B058	9	22	KLDR30, LP- CC-30, ATDR30	30	JLS40, JKS-40, A4J40	40
25	024-41725- 009	AYK580-CF- 027A-6+B058	9	27	JTD40, LPJ-40SP, AJT40	40	JLS40, JKS-40, A4J40	40
30	024-41726- 001	AYK580-CF- 032A-6+B058	15	32	JTD50, LPJ-50SP, AJT50	50	JLS40, JKS-40, A4J40	40
40	024-41728- 006	AYK580-CF- 041A-6+B058	15	41	JTD60, LPJ-60SP, AJT60	60	JLS50, JKS-50, A4J50	50
50	024-41728- 007	AYK580-CF- 052A-6+B058	32	52	JTD90, LPJ-90SP, AJT90	90	JLS80, JKS-80, A4J80	80
60	024-41728- 008	AYK580-CF- 062A-6+B058	32	62	JTD100, LPJ- 100SP, AJT100	100	JLS80, JKS-80, A4J80	80
75	024-41729- 001	AYK580-CF- 077A-6+B058	32	77	JTD125, LPJ- 125SP, AJT125	125	JLS100, JKS-100, A4J100	100
100	024-41732- 007	AYK580-CF- 099A-6+B058	32	99	JTD150, LPJ- 150SP, AJT150	150	JLS150, JKS-150, A4J150	150
125	024-41732- 008	AYK580-CF- 125A-6+B058	76	125	JTD200, LPJ- 200SP, AJT200	200	JLS175, JKS-175, A4J175	175

1. The VFD Horsepower is for reference ONLY

Glossary

Ambient Temperature	The air temperature in the chamber in which a powered electronic unit resides. A unit's heat sinks rely on a lower ambient temperature in order to dissipate heat away from sensitive electronics.
Auto-tuning	The ability of a controller to execute a procedure that interacts with a load to determine the proper coefficients to use in the control algorithm. Auto tuning is a common feature of process controllers with PID loops. Auto-tuning is available (for SJ100) as a special command from a digital operator panel. See also <i>digital operator panel</i> .
Base Frequency	The power input frequency for which an AC induction motor is designed to operate. Most motors will specify a 50 to 60 Hz value. The inverters have a programmable base frequency, so you must ensure that parameter matches the attached motor. The term <i>base frequency</i> helps differentiate it from the carrier frequency. See also <i>carrier frequency and frequency setting</i> .
Braking Resistor	A braking resistor is a resistive load attached to a variable speed drive equipped with Dynamic Braking, referred to as a braking chopper. The resistor is used to dissipate regenerative power that exceeds the typical capability of the variable speed drive (see regenerative power).
Break-away Torque	The torque a motor must produce to overcome the static friction of a load, in order to start the load moving.
Brushes	A sliding electrical connection between a fixed post inside the motor housing and a ring on the motor shaft. Typically used in DC motors or low-cost AC motors, brushes route current to windings on the rotor. AC induction motors with a squirrel-cage design do not have the need for brushes. See also <i>commutation</i> and <i>squirrel cage</i> .
Bypass	The term bypass when used in the context of a variable speed drive is a feature of a drive package that incorporates an ability to bypass the variable speed drive in the event it is inoperable and operate the motor on the power line in a traditional manner starting the motor across the power line. The AYK550 is offered with bypass option (see description of AYK550-CD or AYK550-CF).
Carrier Frequency	The frequency of the constant, periodic, switching waveform that the inverter modulates to generate the AC output to the motor. See also <i>PWM</i> .
CE	A regulatory agency for governing the performance of electronic products in Europe. Drive installations designed to have C.E. approval must have particular filter(s) installed in the application.
Choke	Also known as inductor or reactor. This device is used to oppose changes in AC current. Its opposition to changes in current is measured in reactance. Reactance is Measurement of the opposition of a circuit or component to an alternating current, expressed in ohms. In variable frequency drive systems a choke, inductor or reactor are used in many different applications, most notably they are used within the variable speed drive in the DC circuit to attempt to minimize the impact of harmonic current draw from the network. Chokes can be applied external to the inverter to minimize the impact of network harmonics. See <i>also harmonics</i> .
DC Injection Braking	The inverter DC braking feature stops the AC commutation to the motor, and sends a DC current through the motor windings in order to stop the motor. Also called "DC injection braking," it has little effect at high speed, and is used as the motor is nearing a stop.
Dead Band	In a control system, the range of input change for which there is no perceptible change in the output. In PID loops, the error term may have a dead band associated with it. Dead band may or may not be desirable; it depends on the needs of the application.

Glossary (continued)

Digital Operator Panel	(DOP) refers first to the operator keypad on the front panel of the inverter. It also includes hand-held remote keypads, which connect to the inverter via a cable. Finally, the DOP Plus is a PC-based software simulation of the keypad devices.
Diode	A semiconductor device which has a voltage-current characteristic that allows current to flow only in one direction, with negligible leakage current in the reverse direction. See also <i>rectifier</i> .
Duty Cycle	<ol style="list-style-type: none"> 1. The percent of time a square wave of fixed frequency is on (high) versus off (low). 2. The ratio of operating time of a motor, braking resistor, etc. to its resting time. This parameter usually is specified 0 in association with the allowable thermal rise for the device.
Dynamic Braking	The optional dynamic braking unit also known as a dynamic brake chopper is the electronic switch that is used to dissipate regenerative power from the variable speed drive (see regenerative power). The Dynamic brake requires a braking resistor (a separate additional option) to be operational.
Error	In process control, the error is the difference between the desired value or setpoint (SP) and the actual value of a the process variable (PV). See also <i>process variable</i> and <i>PID Loop</i> .
EMI	Electromagnetic Interference – In motor/drive systems, the switching of high currents and voltages creates the possibility of generating radiated electrical noise that may interfere with the operation of nearby sensitive electrical instruments or devices. This issue is a physics issue that is applicable to all PWM variable speed drives. Certain aspects of an installation, such as long motor lead wire lengths, tend to increase the chance of EMI. Proper installation following the manufacturer's guidelines is the best means of minimizing the impact of this radiated noise from cabling connecting the variable speed drive to the motor.
Four-quadrant operation	Referring to a graph of torque versus direction, a four-quadrant drive can turn the motor either forward or reverse, as well as decelerate in either direction (see also <i>regenerative power</i>). A load that has a relatively high inertia and must move in both directions and change directions rapidly requires four-quadrant capability from its drive.
Free-run Stop	A method of stopping a motor, caused when the inverter simply turns off its motor output connections. This may allow the motor and load to coast to a stop, or a mechanical brake may intervene and shorten the deceleration time.
Frequency Setting	While frequency has a broad meaning in electronics, it typically refers to motor speed for variable-frequency drives (inverters). This is because the output frequency of the inverter is variable, and is proportional to the attained motor speed. For example, a motor with a base frequency of 60 Hz can be speed controlled with an inverter output varying from 0 to 60 Hz. See also <i>base frequency</i> , <i>carrier frequency</i> , and <i>slip</i> .
Harmonics	According to Fourier Series mathematics, a periodic (repeating) function (waveform) can be expressed as a the summation of a series of pure sine waves of related frequencies. The lowest frequency is the fundamental, while all the other wave components are called <i>harmonics</i> . The square waves used in inverters produce high-frequency harmonics, even though the main goal is to produce lower-frequency sine waves. These harmonics can be harmful to electronics (including motor windings) and cause radiated energy that interferes with nearby electronic devices. A choke is sometimes used to suppress the transmission of harmonics in an electrical system. See also <i>choke</i> .
Horsepower	A unit of physical measure to quantify the amount of work done per unit of time. You can directly convert between horsepower and Watts as measurements of power.

IEEE 519	An industry standard which specifies allowable current and voltage distortion levels in an electrical distribution system. The current distortion levels are defined by the ratio of I_{SC} / I_L . Where I_{SC} is the short circuit current available from the source transformer and I_L is the maximum load demand current. The resulting ratio defines the allowable TDD total demand distortion which ranges from 5% to 20%. The standard also defines the maximum allowable voltage distortion limits defined as 3% for special applications and 5% for general systems.
IGBT	Insulated Gate Bipolar Transistor (IGBT) – a semiconductor transistor capable of conducting very large currents when in saturation and capable of withstanding very high voltages when it is off. This high-power bipolar transistor is the type used in inverters.
Inertia	The natural resistance a stationary object to being moved by an external force. See also <i>momentum</i> .
Intelligent Terminal	A configured input or output logic function on the Hitachi inverters. Each terminal may be assigned one of several functions.
Inverter	A device that electronically changes DC to AC current through a alternating process of switching the input to the output, inverted and non-inverted. A variable speed drive such as the Hitachi L100 is also called an inverter, since it contains three inverter circuits to generate 3-phase output to the motor.
Isolation Transformer	A transformer with 1:1 voltage ratio that provides electrical isolation between its primary and secondary windings. These are typically used on the power input side of the device to be protected. An isolation transformer can protect equipment from a ground fault or other malfunction of nearby equipment, as well as attenuate harmful harmonics and transients on the input power.
Jogging Operation	Usually done manually, a jog command from an operator's panel requests the motor/drive system to run indefinitely in a particular direction, until the machine operator ends the jog operation.
Matrix Filter	A passive filter used to mitigate harmonics on the line side of a drive system.
Momentum	The physical property of a body in motion that causes it to continue to move in a straight line. In the case of motors, the armature and shaft are rotating and possesses angular momentum.
Multi-speed Operation	The ability of a motor drive to store preset discrete speed levels for the motor, and control motor speed according to the currently selected speed preset. The Hitachi inverters have 16 preset speeds.
Motor Load	In motor terminology, motor load consists of the inertia of the physical mass that is moved by the motor and the related friction from guiding mechanisms. See also <i>inertia</i> .
N.E.C	The National Electric Code is a regulatory document that governs electrical power and device wiring and installation in the United States.
NEMA	The National Electric Manufacturer's Association. NEMA Codes are a published series of device ratings standards. Industry uses these to evaluate or compare the performance of devices made by various manufacturers to a known standard.
Power Factor (Displacement)	A measurement of the time phase difference between the fundamental voltage and fundamental current in an AC circuit. It represents the cosine of the angle of the phase difference.

Glossary (continued)

Power Factor (True)	A measurement of the ratio of the real power (kW) to the apparent power (kVA). Distortion power factor takes into account harmonic voltage and current distortion as well as voltage to current displacement.
Ride-Through	If the supply to a frequency converter is lost, the drive may continue to run without external power supply utilizing the kinetic energy of the rotating motor and driven equipment. The power loss ride-through time depends on the relationship between the load and the inertia of the rotating masses.
PID Loop	Proportional - Integral - Derivative – a mathematical model used for process control. A process controller maintains a process variable (PV) at a setpoint (SP) by using its PID algorithm to compensate for dynamic conditions and vary its output to drive the PV toward the desired value. For variable-frequency drives, the process variable is the motor speed. See also <i>error</i> .
Process Variable	A physical property of a process which is of interest because it affects the quality of the primary task accomplished by the process. For an industrial oven, temperature is the process variable. See also <i>PID Loop</i> and <i>error</i> .
PWM	Pulse-width modulation: A type of AC adjustable frequency drive that accomplishes frequency and voltage control at the output section (inverter) of the drive. The drive output voltage waveform is at a constant amplitude, and by “chopping” the waveform (pulse width-modulating), the average voltage is controlled. The chopping frequency is sometimes called <i>the carrier frequency</i> . The frequency that controls the speed of the motor is shown below as the output frequency. Motor voltage is controlled by the voltage on time versus off time shown of the pulsed DC voltage. In this manner both drive output voltage and drive output frequency can be controlled.

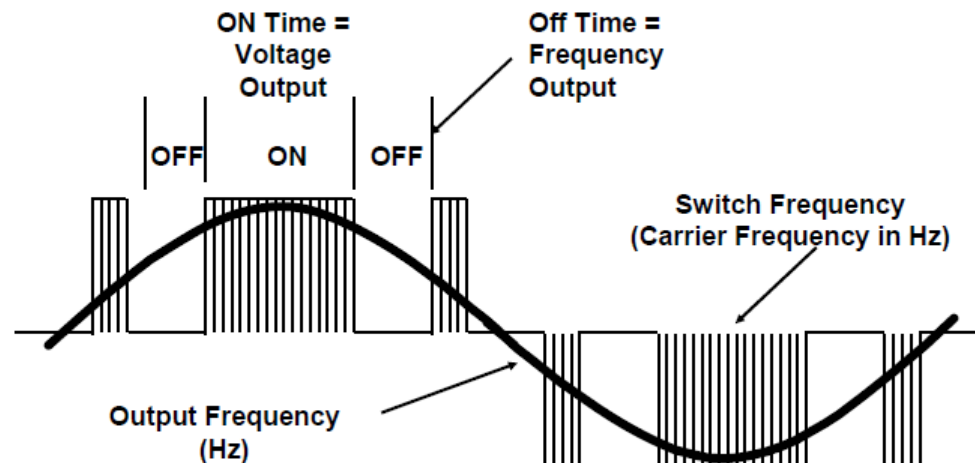

Reactance	The impedance of inductors and capacitors has two components. The resistive part is constant, while the reactive part changes with applied frequency. These devices have a complex impedance (complex number), where the resistance is the real part and the reactance is the imaginary part.
Rectifier	An electronic device made of one or more diodes which converts AC power into DC power. Rectifiers are usually used in combination with capacitors to filter (smooth) the rectified waveform to closely approximate a pure DC voltage source.

Regenerative Braking	A particular method of dissipating regenerative power which is different from a braking chopper and braking resistor where regenerative power is dissipated in heat generated by the resistor during braking. The variable speed drive with regenerative braking can generate the power back on to the power line minimizing heat dissipated into the environment.
Regenerative Power	When a variable speed drive accelerates a load the drive provides voltage and frequency to the motor which define its operating speed and the motor draws current from the variable speed drive based on the motor torque required to accelerate the load. When a motor is decelerated the motor starts to act like a generator and current flow is directed back to the drive. PWM variable speed drives are very efficient with typically 2 to 3% losses. It is these losses that define the variable speed drives ability to absorb regenerative power. When the motor is decelerated the drive must dissipate the energy that exceeds the drives natural losses. In cases where there is not a definite time requirement to stop or reduce a motors speed, variable speed drives have limit functions (typically DC bus over voltage controllers and current limits) that allow the drive to control the rate of deceleration to a level that it can control. In cases where predictable deceleration times or times faster than a motor would coast to a stop, are required see braking resistor or regenerative braking. Typically additional pump and fan applications do not require additional supplemental braking capability.
Regulation	The quality of control applied to maintain a parameter of interest at a desired value. Usually expressed as a percent (+/-) from the nominal, motor regulation usually refers to its shaft speed.
Rotor	The windings of a motor that rotate, being physically coupled to the motor shaft. See also <i>stator</i>
Saturation Voltage	For a transistor semiconductor device, it is in saturation when an increase in input (gate) current no longer results in an increase in the output (source/drain) current. The saturation voltage is the voltage from the power source to the transistor output (V _{source} to V _{drain}). The ideal saturation voltage is zero.
Sensorless Vector Control	A technique used in variable-frequency drives (such as SJ100 series) to rotate the force vector in the motor without the use of a shaft position sensor (angular). Benefits include an increase in torque at the lowest speed and the cost savings from the lack of a shaft position sensor.
Setpoint (SP)	The setpoint is the desired value of a process variable of interest. See also <i>Process Variable (PV)</i> and <i>PID Loop</i> .
Single-phase	An AC power source consisting of Hot and Neutral wires. An Earth Ground connection usually accompanies them. In theory, the voltage potential on Neutral stays at or near Earth Ground, while Hot varies sinusoidally above and below Neutral. This power source is named Single Phase to differentiate it from three-phase power sources. Some Hitachi inverters can accept single phase input power, but they all output three-phase power to the motor. See also <i>three-phase</i> .
Slip	The difference between the theoretical speed of a motor at no load (determined by its inverter output waveforms) and the actual speed. Some slip is essential in order to develop torque to the load, but too much will cause excessive heat in the motor windings and/or cause the motor to stall.
Squirrel Cage	A "nickname" for the appearance of the rotor frame assembly for an AC induction motor.
Stator	The windings in a motor that are stationary and coupled to the power input of the motor. See also <i>rotor</i> .

Glossary (continued)

- Tachometer** 1. A signal generator usually attached to the motor shaft for the purpose of providing feedback to the speed controlling device of the motor. 2. A speed-monitoring test meter which may optically sense shaft rotation speed and display it on a readout.
- Thermal Switch** An electromechanical safety device that opens to stop current flow when the temperature at the device reaches a specific temperature threshold. In variable-speed drive systems, thermal switches are typically installed at or near the motor, in order to protect the windings from heat damage.
- Transistor** A solid state, three-terminal device that provides amplification of signals and can be used for switching and control. While transistors have a linear operating range, inverters use them as high-powered switches. Recent developments in power semiconductors has produced transistors capable of handling hundreds of volts and tens of Amperes or more, all with high reliability. The saturation voltage has been decreasing, resulting in less heat dissipation. Hitachi inverters use state-of-the-art semiconductors to provide high performance and reliability, all in a compact package. See also *IGBT* and *saturation voltage*.
- Trip** An event which causes the inverter to stop operation is called a “trip” event (as *intripping* a circuit breaker). The inverter keeps a history log of trip events. They also require an action to clear.
- Twelve Pulse** A type of drive system consisting of a phase shift input transformer, (2) six-pulse diode module front ends and an inverter section, used to control a motor and reduce input side line harmonics.
- Variable Speed Drive** A variable speed drive is an electronic device used to control the speed of an AC motor. It converts the incoming alternating current (AC) fixed voltage and frequency to a adjustable voltage and frequency output. This adjustable output is connected to a standard AC induction motor to control its speed.
- The most popular type of Low Voltage (600VAC and below) variable speed Drive is a PWM Inverter. A PWM variable speed drive is a voltage source inverter supplied with converter section made up of a six pulse rectifier (6 diodes creating a three phase full wave bridge) used for conversion of AC voltage from the power line to DC voltage used in the variable speed drive inverter section to generate the PWM output wave form for the motor (see PWM).

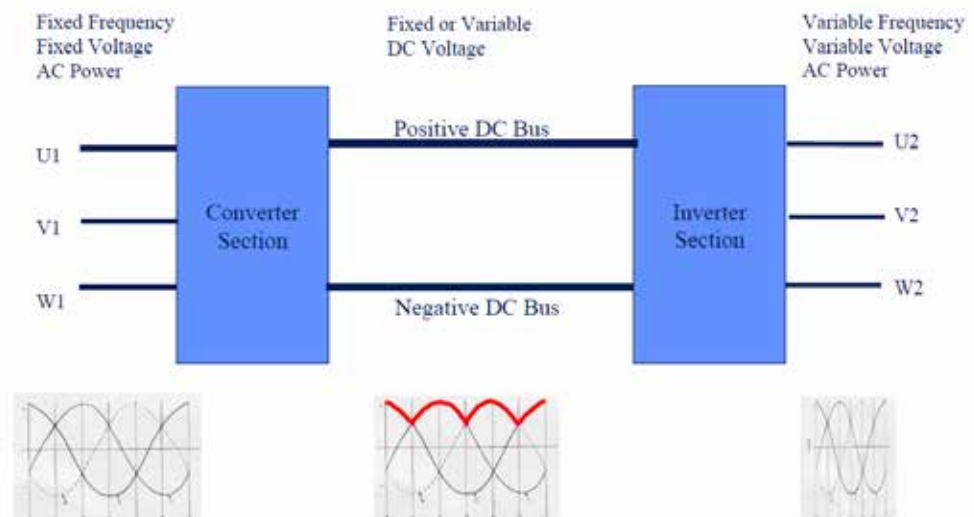

Notes



Printed on recycled paper

New Release
© 2020 Johnson Controls, Inc. P.O. Box 423, Milwaukee, WI 53201 Printed in USA
www.johnsoncontrols.com

